



30TH

ANNIVERSARY



TEAM SPORTS - STRENGTH & FITNESS - FACILITIES - P.E.

REACTOR
REHABILITATION BALLS

2023 CATALOG

BRANDS YOU DEMAND

GEAR
PRO-TEC

Rawlings

MacGregor

US Games

Z-COOL

Voit

igloo

EKHO

REACTOR
BY CHAMPION BARBELL

SPALDING

MARKERS, INC.
Quality Products at Reasonable Prices

GILL
ATHLETICS

ALUMIGOAL

Wilson

MAVERIK
LACROSSE

GAMECRAFT

EASTON

PRO-DOWN

CHAMPION
BARBELL

BRINE

Gold Medal
ATHLETIC PRODUCTS

DeMARINI

MIKASA
SPORTS
USA

SPORTS
COOL

Mizuno

Diamond

TRIPLE
THREAT

DUDLEY

TITAN

PORTaPIT

GSC

MARK 1

HEAD

FitnEX

WORTH

FLAGTAG

Harrow

DUNLOP

TACHIKARA

shield

deBeer
LACROSSE

ACCUSPLIT

GRIZZLY

DIAMOND
PRO

ALL-STAR

Framer

FOUNDED
EDWARDS
1911
SPORTS PRODUCTS LTD

RolDri

Baden
PASSION FOR A BETTER GAME

BOW
NET

OC

FISHER

G

STX
LACROSSE

Bison

SELECT
player's choice

TEAM SPORTS

BENCHES & BLEACHERS	004 - 011
PARKS	012 - 015
BASEBALL / SOFTBALL	016 - 081
Backstops & Cages	016 - 022
Batting Tunnels	023 - 025
Protective Screens	026 - 027
Windscreen	028 - 029
Field Accessories	030 - 039
Field Maintenance	040 - 047
Bases	048 - 053
Pitching Machines & Mounds	054 - 055
Baseballs & Softballs	056 - 069
Training Aids	070 - 071
Bags	072 - 073
Catcher's Gear & Gloves/Mitts	074 - 076
Scorebooks & Umpire Equipment	077 - 079
MLB Replica	080 - 081
BASKETBALL	082 - 101
Basketballs	082 - 087
Backboards, Goals & Systems	088 - 096
Accessories	097 - 101
FOOTBALL	102 - 133
Footballs	102 - 103
Tackling & Training Aids	104 - 108
Field Accessories	109 - 113
Shoulder Pads & Girdles	114 - 129
Football Accessories	130 - 131
Flag Football Belts & Accessories	132 - 133
HYDRATION	134 - 135
LACROSSE	136 - 149
SPORTS MEDICINE	140 - 141
SOCCER	142 - 161
Balls	142 - 145
Goals & Nets	146 - 152
Accessories	153 - 159
RACQUET SPORTS	160 - 175
Tennis Post & Nets	160 - 161
Rol Dri / Tennis Accessories	162
Scorekeepers / Storage / Tidi-Court	163 - 167

Balls & Racquets	168 - 169
Badminton & Racquet Ball	170 - 173
Pickle Ball	174 - 175

TRACK & FIELD

Pit & Pit Accessories	176 - 183
Hurdles & Starting Blocks	184 - 187
Discus & Shots	188 - 189
Track Accessories	190 - 195

VOLLEYBALL

Balls	196 - 200
Storage & Score Keepers	201
Systems	202 - 205
Nets & Accessories	206 - 209

WRESTLING MATS

STRENGTH & FITNESS

WEIGHT LIFTING EQUIPMENT

212 - 226

CARDIO

227 - 233

Bikes, Treadmills, Gym Flooring	227 - 234
Kettlebells & Medicine Balls	235 - 237
Bands / Chinning / Fitness Balls	238 - 240
Mats / Rollers / BOSU	241 - 243
Plyo Boxes / Jump Ropes / Accessories	244 - 245

SPEED & AGILITY

246 - 247

ASSESSMENT

248 - 249

WALL PADS

250 - 251

FLOOR COVERS

252

GYM MATS

253 - 255

COACHING & INFLATORS

256 - 257

FACILITY

SCOREBOARDS

258 - 259

STORAGE

260 - 263

GAME TABLES & BOARD GAMES

264 - 267

PHYSICAL EDUCATION

Playground Balls & Value Packs	268 - 269
Cones / Hoops / Jump Ropes / Scooters	270 - 271
Lawn Games	272 - 273
Archery	274 - 276



15' ANODIZED ALUMINUM



15' NAVY BLUE

PLAYER'S BENCH WITH SHELF

- Finally, players and coaches have a place for equipment
- Features 10"W anodized or powder coated planks
- 20"W rear shelf
- All aluminum construction.
- Portable or surface mount (requires drilling holes in framework)

5 Year Limited Warranty

ANODIZED ALUMINUM		
LENGTH	CODE	PRICE
7.5'	BEPS08	\$1,099 ⁹⁹ ★
15'	BEPS15	\$1,699 ⁹⁹ ★
21'	BEPS21	\$1,999 ⁹⁹ ★
27'	BEPS27	\$2,999 ⁹⁹ ★
POWDER-COATED (SELECT COLOR)		
7.5'	BEPS08C	\$1,299 ⁹⁹ ★
15'	BEPS15C	\$1,999 ⁹⁹ ★
21'	BEPS21C	\$2,499 ⁹⁹ ★



Shelf space allows place for helmets, scorebooks, caps, water bottles, gloves, etc.



FOREST GREEN

SCORERS TABLE WITH BENCH

- Table and bench are 7.5' L
- All aluminum construction
- Features 10"W anodized or powder coated aluminum seat planks
- 20"W ribbed aluminum table top.
- If choosing powder coated, specify color: Forest Green, Navy Blue, Red, Royal Blue

5 Year Limited Warranty

BEST08	Natural Aluminum	\$1,099 ⁹⁹ EA ★
BEST08C	Powder Coated	\$1,099 ⁹⁹ EA ★



ALUMINUM

NAVY BLUE

SCARLET RED

ROYAL BLUE



5' COURTSIDE BENCH

- Heavy duty aluminum bench with back
- 2 3/8" OD galvanized steel legs
- Planks are powder coated and come with safety end caps

5 Year Limited Warranty

BEPG05G	Forest Green	\$899 ⁹⁹ EA ★
BEPG05W	White	\$899 ⁹⁹ EA ★

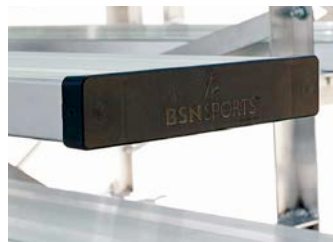

SAFETY END CAPS

- UV treated poly endcaps
- No Sharp edges
- Designed to fit BSN Sports planks only
- Sold in pack of 6
- Hardware included

ZENDCAP \$44⁹⁹ PACK ★



GYM FLOOR PROTECTOR KIT

- Non-marring floor protectors
- Fit any 2 3/8" O.D. material

5 Year Limited Warranty

BEPROT8	7 1/2" Bench kit	\$21 ⁹⁹ KIT OF 4
BEPROT15	15" Bench kit	\$29 ⁹⁹ KIT OF 6

ADD COLOR TO YOUR BENCHES!

SPECIFY COLOR WHEN ORDERING



PLAYER'S BENCH WITH BACK

THE BEST PLAYER'S BENCHES AVAILABLE...GUARANTEED!

- Seat planks are 10" wide with a ribbed no-slip surface.
- Planks are anodized aluminum and will not rub off on clothing
- Comes with Safety End Caps -No sharp edges to snag clothing or skin
- Legs are constructed of heavy duty commercial grade 2-3/8" O.D. galvanized steel
- Portable models are designed for indoor and outdoor use and come complete with non-marring floor protectors

5 Year Limited Warranty



ANODIZED ALUMINUM				
	IN-GROUND	PORTABLE	SURFACE-MOUNT	
LENGTH	CODE	CODE	CODE	PRICE
7.5'	BEPB08	BEPG08	BEPH08	\$899 ⁹⁹ ★
15'	BEPB15	BEPG15	BEPH15	\$1,099 ⁹⁹ ★
21'	BEPB21	BEPG21	BEPH21	\$1,399 ⁹⁹ ★
27'	BEPB27	BEPG27	BEPH27	\$1,599 ⁹⁹ ★

POWDER-COATED (SELECT COLOR)				
	IN-GROUND	PORTABLE	SURFACE-MOUNT	
LENGTH	CODE	CODE	CODE	PRICE
7.5'	BEPB08C	BEPG08C	BEPH08C	\$999 ⁹⁹ ★
15'	BEPB15C	BEPG15C	BEPH15C	\$1,399 ⁹⁹ ★
21'	BEPB21C	BEPG21C	BEPH21C	\$1,499 ⁹⁹ ★

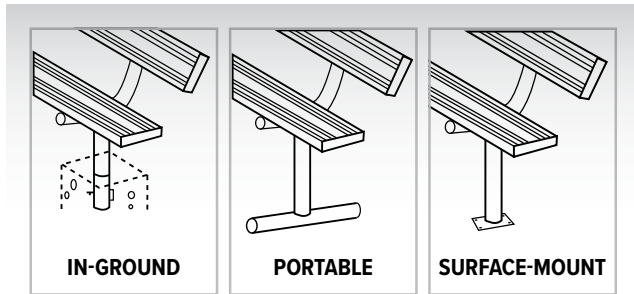
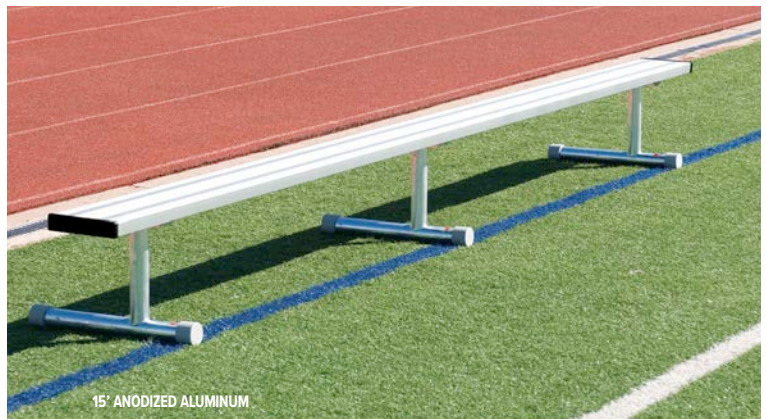

PLAYER'S BENCH WITHOUT BACK

• Same features as listed above - simply sold without the back rest

5 Year Limited Warranty



ANODIZED ALUMINUM				
	IN-GROUND	PORTABLE	SURFACE-MOUNT	
LENGTH	CODE	CODE	CODE	PRICE
7.5'	BEPD08	BEPI08	BEPE08	\$699 ⁹⁹ ★
15'	BEPD15	BEPI15	BEPE15	\$899 ⁹⁹ ★
21'	BEPD21	BEPI21	BEPE21	\$999 ⁹⁹ ★
27'	BEPD27	N/A	BEPE27	\$1,399 ⁹⁹ ★

POWDER-COATED (SELECT COLOR)				
	IN-GROUND	PORTABLE	SURFACE-MOUNT	
LENGTH	CODE	CODE	CODE	PRICE
7.5'	BEPD08C	BEPI08C	BEPE08C	\$799 ⁹⁹ ★
15'	BEPD15C	BEPI15C	BEPE15C	\$999 ⁹⁹ ★
21'	BEPD21C	BEPI21C	BEPE21C	\$1,199 ⁹⁹ ★

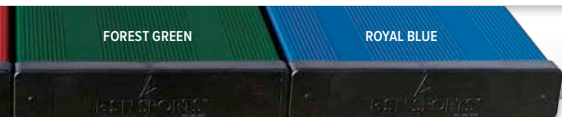

CALL FOR DISCOUNTED PRICING ON BULK ORDERS



PREFERRED, 15' FOREST GREEN

NOTE: Bleachers are shipped knocked down.

LOW RISE BLEACHERS

- Specially designed frames that allows 4 rows of seating without the need for safety fencing.
- Frames are 100% welded aluminum angle
- First row has a seat height of 12"
- Top row has a seat height of 29"
- Seat planks are anodized aluminum or powder coated and won't rub off on clothes!
- Standard models include single foot planks
- Preferred models include double foot planks
- Due to constantly changing specifications, Please check local building and safety codes to ensure bleacher compliance.



5 Year Limited Warranty



STANDARD - Single Foot Planks



PREFERRED - Double Foot Planks

ANODIZED ALUMINUM 								
ROWS	LXHXD	SEATS	STANDARD	PREFERRED	STANDARD	PRICE	PREFERRED	PRICE
4	7.5'x30"x81"	20	155 lbs	200 lbs	LR0408	\$2,899 ⁹⁹ ★	LR0408P	\$3,399 ⁹⁹ ★
4	15'x30"x81"	40	270 lbs	355 lbs	LR0415	\$3,699 ⁹⁹ ★	LR0415P	\$4,099 ⁹⁹ ★
4	21'x30"x81"	56	385 lbs	500 lbs	LR0421	\$4,599 ⁹⁹ ★	LR0421P	\$4,899 ⁹⁹ ★
4	27'x30"x81"	72	500 lbs	665 lbs	LR0427	\$4,999 ⁹⁹ ★	LR0427P	\$5,899 ⁹⁹ ★
POWDER-COATED (SELECT COLOR) 								
ROWS	LXHXD	SEATS	STANDARD	PREFERRED	STANDARD	PRICE	PREFERRED	PRICE
4	7.5'x30"x81"	20	155 lbs	200 lbs	LR0408C	\$2,799 ⁹⁹ ★	LR0408CP	\$3,699 ⁹⁹ ★
4	15'x30"x81"	40	270 lbs	355 lbs	LR0415C	\$3,899 ⁹⁹ ★	LR0415CP	\$4,399 ⁹⁹ ★
4	21'x30"x81"	56	385 lbs	500 lbs	LR0421C	\$4,799 ⁹⁹ ★	LR0421CP	\$5,099 ⁹⁹ ★

We build our benches & bleachers to the highest standards. Listed below are some of the differences by others who may be listing their benches & bleachers as comparable to ours.

1. Frames - Ours are 100% aluminum angle. Be careful of those quoting "galvanized, steel angle iron" as equal.
2. Seat Planks - Ours are 100% anodized aluminum with a minimum wall thickness of .078 in. A thinner walled unit does not have the strength or support.
3. End Caps - Ours are constructed of fiber reinforced polypropylene. No sharp edges to snag clothing or skin.

4. Indoor Use - Our Tip N' Roll units come with rubber leg protectors so they can be used indoors or out. Be careful of those units using steel vs aluminum. In a "tip-over" fashion, steel could damage your gym floor or cause personal injuries.

Don't be fooled by a low price. Our manufacturing team has been in this business for 30 years. If you see bids or quotes that "seem too good to be true" - they are. Respectable manufacturers purchase aluminum at the same prices. Anyone offering to deliver product at 30% less is not matching specs.

ADD COLOR TO YOUR BLEACHERS!

SPECIFY COLOR WHEN ORDERING





NOTE: Bleachers are shipped knocked down.

STANDARD 3 ROW,
15' ANODIZED ALUMINUM



PREFERRED 2 ROW, 15' ROYAL BLUE



PREFERRED 3 ROW, 15' SCARLET

BLEACHERS WITHOUT FENCING

- Frames are 100% welded aluminum angle
- First row has a seat height of 18"
- Top row has a seat height of 29"
- Planks are 10"W
- Due to constantly changing specifications, please check local building and safety codes to ensure bleacher compliance
- Standard models include single foot planks
- Preferred models include double foot planks

5 Year Limited Warranty



STANDARD - Single Foot Planks



PREFERRED - Double Foot Planks

ANODIZED ALUMINUM

ROWS	LXHXD	SEATS	STANDARD	PREFERRED	STANDARD	PRICE	PREFERRED	PRICE
2	15'x24"x36"	20	126 lbs	157 lbs	NB0215	\$2,399 ⁹⁹ ★	NB0215P	\$2,899 ⁹⁹ ★
2	21'x24"x36"	28	170 lbs	213 lbs	NB0221	\$2,799 ⁹⁹ ★	NB0221P	\$3,199 ⁹⁹ ★
3	15'x30"x60"	30	203 lbs	263 lbs	NB0315	\$3,099 ⁹⁹ ★	NB0315P	\$3,499 ⁹⁹ ★
3	21'x30"x60"	42	280 lbs	360 lbs	NB0321	\$3,499 ⁹⁹ ★	NB0321P	\$3,699 ⁹⁹ ★
3	27'x30"x60"	54	367 lbs	476 lbs	NB0327	\$4,099 ⁹⁹ ★	NB0327P	\$4,299 ⁹⁹ ★

POWDER-COATED (SELECT COLOR)

ROWS	LXHXD	SEATS	STANDARD	PREFERRED	STANDARD	PRICE	PREFERRED	PRICE
2	15'x24"x36"	20	126 lbs	157 lbs	NB0215C	\$2,699 ⁹⁹ ★	NB0215CP	\$2,899 ⁹⁹ ★
2	21'x24"x36"	28	170 lbs	213 lbs	NB0221C	\$3,099 ⁹⁹ ★	NB0221CP	\$3,199 ⁹⁹ ★
3	15'x30"x60"	30	203 lbs	263 lbs	NB0315C	\$3,299 ⁹⁹ ★	NB0315CP	\$3,499 ⁹⁹ ★
3	21'x30"x60"	42	280 lbs	360 lbs	NB0321C	\$3,799 ⁹⁹ ★	NB0321CP	\$3,999 ⁹⁹ ★



**CALL FOR DISCOUNTED PRICING
ON BULK ORDERS**



STANDARD - Single Foot Planks



NOTE: Bleachers are shipped knocked down.

BLEACHERS WITH FENCING

- Frames are 100% welded aluminum angle
- Planks are 10" W
- Seat planks are anodized aluminum or powder coated and won't rub off on clothes
- Bleachers include guardrail system and riser boards on rows 4 and above
- Colored bleachers include colored seat planks only
- Planks include safety end caps - no sharp edges to snag clothes or skin
- Due to constantly changing specifications, please check local building and safety codes to ensure compliance

5 Year Limited Warranty



ANODIZED ALUMINUM

ROWS	LENGTH	SEATS	WEIGHT	CHAIN-LINK	PRICE	VERTICAL PICKET	PRICE
4	15'	40	596 lbs	NB0415	\$5,399 ⁹⁹ ★	NB0415V	\$6,399 ⁹⁹ ★
4	21'	56	777 lbs	NB0421	\$6,299 ⁹⁹ ★	NB0421V	\$7,299 ⁹⁹ ★
4	27'	72	970 lbs	NB0427	\$6,899 ⁹⁹ ★	NB0427V	\$8,399 ⁹⁹ ★
5	15'	50	749 lbs	NB0515	\$6,399 ⁹⁹ ★	NB0515V	\$7,399 ⁹⁹ ★
5	21'	70	992 lbs	NB0521	\$7,799 ⁹⁹ ★	NB0521V	\$9,499 ⁹⁹ ★
5	27'	90	1250 lbs	NB0527	\$9,499 ⁹⁹ ★	NB0527V	\$11,499 ⁹⁹ ★

POWDER-COATED (SELECT COLOR)

ROWS	LENGTH	SEATS	WEIGHT	CHAIN-LINK	PRICE	VERTICAL PICKET	PRICE
4	15'	40	596 lbs	NB0415C	\$5,699 ⁹⁹ ★	NB0415CV	\$6,699 ⁹⁹ ★
4	21'	56	777 lbs	NB0421C	\$6,599 ⁹⁹ ★	NB0421CV	\$7,599 ⁹⁹ ★
5	15'	50	749 lbs	NB0515C	\$6,299 ⁹⁹ ★	NB0515CV	\$7,799 ⁹⁹ ★
5	21'	70	992 lbs	NB0521C	\$8,399 ⁹⁹ ★	NB0521CV	\$9,699 ⁹⁹ ★

ADD COLOR TO YOUR BLEACHERS!

SPECIFY COLOR WHEN ORDERING





4 ROW, 15' SCARLET RED WITH VERTICAL PICKETS



PREFERRED - Double Foot Planks



NOTE: Bleachers are shipped knocked down.

PREFERRED BLEACHERS WITH FENCING

- Frames are 100% welded aluminum angle
- Seat planks are anodized or powder coated (where applicable)
- Bleachers include guardrail system and riser boards on rows 4 and above
- Chain-link fencing is 9 gauge steel
- Available in 4 & 5 row models
- Available in 15', 21' and 27' long
- Due to constantly changing specifications, please check local building and safety codes to ensure compliance.

5 Year Limited Warranty

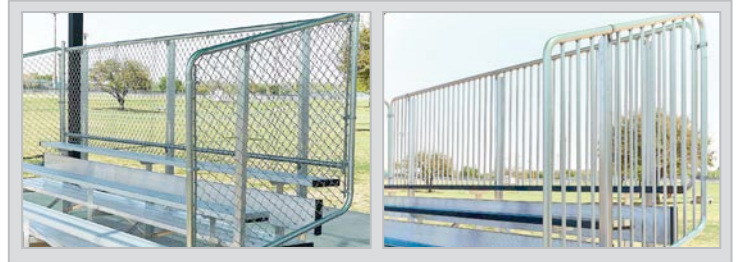

ANODIZED ALUMINUM

ROWS	LENGTH	SEATS	WEIGHT	CHAIN-LINK	PRICE	VERTICAL PICKET	PRICE
4	15'	40	616 lbs	NB0415P	\$5,899 ⁹⁹ ★	NB0415VP	\$6,899 ⁹⁹ ★
4	21'	56	820 lbs	NB0421P	\$6,699 ⁹⁹ ★	NB0421VP	\$8,399 ⁹⁹ ★
4	27'	72	1038 lbs	NB0427P	\$9,999 ⁹⁹ ★	NB0427VP	\$11,999 ⁹⁹ ★
5	15'	50	769 lbs	NB0515P	\$6,799 ⁹⁹ ★	NB0515VP	\$7,999 ⁹⁹ ★
5	21'	70	1032 lbs	NB0521P	\$8,399 ⁹⁹ ★	NB0521VP	\$9,499 ⁹⁹ ★
5	27'	90	1316 lbs	NB0527P	\$11,499 ⁹⁹ ★	NB0527VP	\$13,499 ⁹⁹ ★

POWDER-COATED (SELECT COLOR)

ROWS	LENGTH	SEATS	WEIGHT	CHAIN-LINK	PRICE	VERTICAL PICKET	PRICE
4	15'	40	616 lbs	NB0415CP	\$6,599 ⁹⁹ ★	NB0415CVP	\$7,599 ⁹⁹ ★
4	21'	56	820 lbs	NB0421CP	\$6,899 ⁹⁹ ★	NB0421CVP	\$8,599 ⁹⁹ ★
5	15'	50	769 lbs	NB0515CP	\$7,399 ⁹⁹ ★	NB0515CVP	\$8,299 ⁹⁹ ★
5	21'	70	1032 lbs	NB0521CP	\$8,699 ⁹⁹ ★	NB0521CVP	\$9,699 ⁹⁹ ★

FOREST GREEN

ROYAL BLUE

**CALL FOR DISCOUNTED PRICING
ON BULK ORDERS**



TIP N' ROLL BLEACHERS

- Tip N' Roll bleachers are perfect for auxiliary seating requirements
- Unit easily tips up on its casters for convenient storage
- Frames are 100% welded aluminum angle
- Seat planks are either anodized or powder coated (where applicable)
- High grade swivel casters & rubber foot pads will not mar your floors
- Due to constantly changing specifications, please check local building and safety codes to ensure compliance
- Standard models include single foot planks
- Preferred models include double foot planks
- WARNING: These lightweight units are easily tipped up for rolling by any responsible adult. However, if tipped up outdoors, extreme caution should be taken in windy conditions. Multiple adults may be required to control the unit

5 Year Limited Warranty



STANDARD - Single Foot Planks

PREFERRED - Double Foot Planks

ANODIZED ALUMINUM SAFETY								
ROWS	LXHXD	SEATS	STANDARD	PREFERRED	STANDARD	PRICE	PREFERRED	PRICE
2	7.5'x24"x36"	10	72 lbs	89 lbs	TR0208	\$2,189 ⁹⁹ ★	TR0208P	\$2,289 ⁹⁹ ★
2	15'x24"x36"	20	131 lbs	162 lbs	TR0215	\$2,599 ⁹⁹ ★	TR0215P	\$2,789 ⁹⁹ ★
2	21'x24"x36"	28	175 lbs	219 lbs	TR0221	\$3,089 ⁹⁹ ★	TR0221P	\$3,299 ⁹⁹ ★
3	7.5'x30"x60"	15	116 lbs	133 lbs	TR0308	\$2,699 ⁹⁹ ★	TR0308P	\$2,789 ⁹⁹ ★
3	15'x30"x60"	30	207 lbs	252 lbs	TR0315	\$2,899 ⁹⁹ ★	TR0315P	\$3,299 ⁹⁹ ★
3	21'x30"x60"	42	265 lbs	345 lbs	TR0321	\$3,599 ⁹⁹ ★	TR0321P	\$3,999 ⁹⁹ ★
3	27'x30"x60"	54	352 lbs	N/A	TR0327	\$4,199 ⁹⁹ ★	N/A	N/A
4*	7.5'x30"x81"	20	146 lbs	190 lbs	TR0408	\$3,199 ⁹⁹ ★	TR0408P	\$3,599 ⁹⁹ ★
4*	15'x30"x81"	40	295 lbs	384 lbs	TR0415	\$3,899 ⁹⁹ ★	TR0415P	\$4,299 ⁹⁹ ★
4*	21'x30"x81"	56	398 lbs	524 lbs	TR0421	\$4,399 ⁹⁹ ★	TR0421P	\$4,899 ⁹⁹ ★
POWDER-COATED SAFETY - SELECT YOUR COLOR								
ROWS	LENGTH	SEATS	STANDARD	PREFERRED	STANDARD	PRICE	PREFERRED	PRICE
2	7.5'x24"x36"	10	72 lbs	89 lbs	TR0208C	\$2,099 ⁹⁹ ★	TR0208CP	\$2,199 ⁹⁹ ★
2	15'x24"x36"	20	131 lbs	162 lbs	TR0215C	\$2,699 ⁹⁹ ★	TR0215CP	\$2,799 ⁹⁹ ★
2	21'x24"x36"	28	175 lbs	219 lbs	TR0221C	\$3,099 ⁹⁹ ★	TR0221CP	\$3,599 ⁹⁹ ★
3	7.5'x30"x60"	15	116 lbs	133 lbs	TR0308C	\$2,599 ⁹⁹ ★	TR0308CP	\$2,899 ⁹⁹ ★
3	15'x30"x60"	30	207 lbs	252 lbs	TR0315C	\$3,199 ⁹⁹ ★	TR0315CP	\$3,599 ⁹⁹ ★
3	21'x30"x60"	42	265 lbs	345 lbs	TR0321C	\$3,799 ⁹⁹ ★	TR0321CP	\$4,099 ⁹⁹ ★
4*	7.5'x30"x81"	20	146 lbs	190 lbs	TR0408C	\$3,299 ⁹⁹ ★	TR0408CP	\$3,799 ⁹⁹ ★
4*	15'x30"x81"	40	295 lbs	384 lbs	TR0415C	\$3,999 ⁹⁹ ★	TR0415CP	\$4,499 ⁹⁹ ★
4*	21'x30"x81"	56	398 lbs	524 lbs	TR0421C	\$4,699 ⁹⁹ ★	TR0421CP	\$5,099 ⁹⁹ ★

*4 Row models feature low rise framework. See page 6 for full details.

**ADD COLOR TO YOUR
TIP N' ROLL BLEACHERS!**
SPECIFY COLOR WHEN ORDERING

NAVY BLUE

SCARLET RED

FOREST GREEN

ROYAL BLUE

CALL FOR DISCOUNTED PRICING ON BULK ORDERS!



PLEASE ALLOW 3 TO 4 WEEKS FOR DELIVERY.

VIP SERIES BLEACHERS

- Frames are 100% welded aluminum angle
- 2" x 10" anodized aluminum seat planks
- 2 - 2" x 10" foot planks on every row
- 2" x 10" riser on top row and 1" x 6" risers on all other rows
- 2" 9 gauge fence railing on all chain-link models
- 4.5' aisle with aluminum hand rail on select models

5 Year Limited Warranty

ROWS	LENGTH	SEATS	RAILING	AISLE	CHAIN-LINK	VERTICAL PICKET
5	21'	58	✓	✓	1049185 \$13,999 ⁹⁹	1196542 \$22,999 ⁹⁹
8	15'	80	✓		1135190 \$16,999 ⁹⁹	1196559 \$22,899 ⁹⁹
8	21'	112	✓		1135206 \$20,699 ⁹⁹	1196566 \$27,899 ⁹⁹
8	21'	91	✓	✓	1135220 \$25,499 ⁹⁹	1196580 \$29,999 ⁹⁹
8	27'	144	✓		1135213 \$27,999 ⁹⁹	1196573 \$33,899 ⁹⁹
8	27'	116	✓	✓	1135237 \$29,999 ⁹⁹	1196597 \$39,999 ⁹⁹
10	15'	100	✓		1135244 \$20,899 ⁹⁹	1196603 \$24,699 ⁹⁹
10	21'	140	✓		1135251 \$27,399 ⁹⁹	1196610 \$29,899 ⁹⁹
10	21'	113	✓	✓	1135275 \$29,699 ⁹⁹	1196634 \$34,499 ⁹⁹
10	27'	180	✓		1135268 \$33,999 ⁹⁹	1196627 \$38,299 ⁹⁹
10	27'	144	✓	✓	1135282 \$35,999 ⁹⁹	1196641 \$45,499 ⁹⁹

TRANSPORTABLE PREFERRED BLEACHERS

- Designed to be moved around your grounds (5 mph max)
 - Each transportable bleacher is fitted with a galvanized steel horizontal lifting brace, and has extra bracing to stabilize the bleacher during transport.
 - Transportable bleachers come with ground sills and require the purchase of one transport kit which can move several bleachers, one at a time
 - Both Preferred and Deluxe Bleachers feature double foot planks on all rows w/single seat planks, riser closure on rows 4 and up with chain-link guardrail starting at row 3.
 - Deluxe Bleachers also include the added benefit of a handrail
- 5 Year Limited Warranty**



PREFERRED DESIGN BLEACHERS					
ROWS	LENGTH	SEATS	WEIGHT	CODE	PRICE
5	15'	50	1028 lbs	NBT0515P	\$12,999 ⁹⁹
5	21'	70	1446 lbs	NBT0521P	\$13,799 ⁹⁹
5	24'	80	1559 lbs	NBT0524P	\$15,999 ⁹⁹
10	15'	100	2161 lbs	NBT1015P	\$20,999 ⁹⁹
10	21'	140	3068 lbs	NBT1021P	\$29,799 ⁹⁹
10	24'	160	3285 lbs	NBT1024P	\$32,099 ⁹⁹

DELUXE DESIGN BLEACHERS					
ROWS	LENGTH	SEATS	WEIGHT	CODE	PRICE
5	21'	58	1519 lbs	NBT0521D	\$15,499 ⁹⁹
5	24'	68	1641 lbs	NBT0524D	\$16,999 ⁹⁹
10	21'	113	3193 lbs	NBT1021D	\$36,199 ⁹⁹
10	24'	133	3422 lbs	NBT1024D	\$36,299 ⁹⁹



TRANSPORT KIT (REQUIRED)

5 Year Limited Warranty

NBTK5
NBTK10

5 Row Transport Kit - Required with 5 row Transportable Bleachers
10 Row Transport Kit - Required with 10 Row Transportable Bleachers

\$3,999⁹⁹ EA
\$7,799⁹⁹ EA

HEAVY DUTY RECTANGULAR TABLE

- 6', 8', 10' and 12' lengths available
- 2-3/8" diameter all welded frame with powder coat finish
- Diamond and Perforated patterns available
- 1 or 2 sided ADA 8' versions
- Table is both Portable and Surface Mount (mounting hardware not included)

5 Year Limited Warranty



WIDE WALK THROUGH DESIGN FOR EASY ENTRY & EXIT



SIZE	STYLE	DIAMOND	PERFORATED	PRICE EA.	DELIVERY
6'	Walk-thru	1275353	1275360	\$2,199 ⁹⁹	
8'	Walk-thru	1275377	1275384	\$2,399 ⁹⁹	
8' ADA	Double sided	1275438	1275445	\$2,057 ⁹⁹	
8' ADA	Single sided	1275452	1275469	\$2,149 ⁹⁹	
10'	Walk-thru	1275391	1275407	\$2,899 ⁹⁹	
12'	Walk-thru	1275414	1275421	\$2,999 ⁹⁹	

THE THERMOPLASTIC ADVANTAGE!

- High thermal stability keeps seats and tables cooler
- More corrosion and rust-resistant than other coatings
- Products are more durable and last longer
- FDA approved non-stick surface confidence in user safety for food contact



46" SQUARE AND ROUND TABLES

- 1-5/8" diameter steel frame with powder coat finish
- Diamond and Perforated patterns available
- Portable and/or Surface Mount (mounting hardware not included)
- Includes center umbrella hole

5 Year Limited Warranty



Square

SIZE	STYLE	DIAMOND	PERFORATED	PRICE EA.	DELIVERY
46"	Square	1275476	1275483	\$2,199 ⁹⁹	
46"	Round	1275490	1275506	\$2,399 ⁹⁹	

RECTANGULAR PEDESTAL TABLE

- 4' and 6' lengths available
- Heavy-duty 4" square steel center post
- 3" square steel support arm posts
- Diamond and Perforated patterns available
- In-Ground or Surface Mount
- ADA compliant

5 Year Limited Warranty



In-Ground

SIZE	PATTERN	IN-GROUND	SURFACE MOUNT	PRICE EA.	DELIVERY
4'	Diamond	1275513	1275520	\$2,949 ⁹⁹	
4'	Perforated	1275537	1275544	\$3,159 ⁹⁹	
6'	Diamond	1275551	1275568	\$3,199 ⁹⁹	
6'	Perforated	1275575	1275582	\$3,374 ⁹⁹	

THERMOPLASTIC & POWDER COAT COLOR OPTIONS:

Tables, benches & receptacles feature rounded corners with either diamond expanded or perforated pattern. All items can be coated with any color shown here.

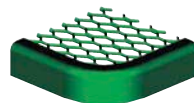

DIAMOND EXPANDED

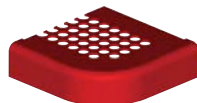

PERFORATED

- BLACK
- BROWN
- GREEN
- DARK BLUE
- BURGANDY
- BLUE
- RED
- BEIGE



HEAVY DUTY PICNIC TABLES

- 6' and 8' lengths available
- 2-3/8" diameter all welded walk through frame
- Pressure treated pine or aluminum plank options available
- 1 or 2 sided ADA 8' versions
- Pre-drilled holes for Portable and Surface Mount (mounting hardware not included)
- Made in the USA

SIZE	STYLE	PRESSURE TREATED		ALUMINUM	
		PRICE	PRICE	PRICE	PRICE
6'	Walk-thru	1275995	\$1,549 ⁹⁹	1276039	\$2,599 ⁹⁹
8'	Walk-thru	1276008	\$1,649 ⁹⁹	1276046	\$2,699 ⁹⁹
8' ADA	Double sided	1276015	\$1,449 ⁹⁹	1276053	\$2,699 ⁹⁹
8' ADA	Single sided	1276022	\$1,649 ⁹⁹	1276060	\$2,699 ⁹⁹

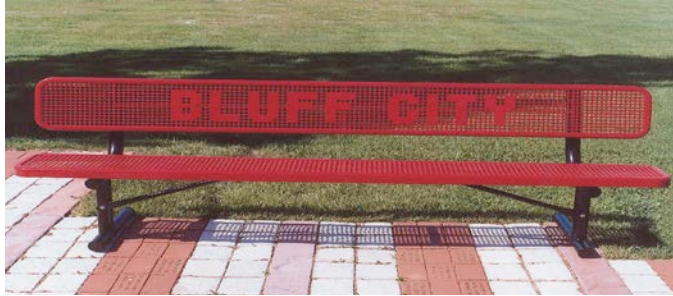

1275629 - 8' PERFORATED PORTABLE BENCH WITH PUNCHED CUSTOM LETTERING

THERMOPLASTIC BENCHES W/CUSTOM LETTERING

- Benches can be customized with either punched or laser-cut lettering for a specialized look
- Available colors: Black, Brown, Green, Dark Blue, Burgundy, Light Blue, Red and Beige
- Call for lettering details

5 Year Limited Warranty

SIZE	PORTABLE	IN-GROUND	SURFACE MOUNT	PRICE EA.	DELIVERY
6'	1275599	1275605	1275612	\$2,560 ⁹⁹	
8'	1275629	1275636	1275643	\$2,656 ⁹⁹	

*Price includes custom lettering



LASER CUT LETTERING
1275667 - 5' LEXINGTON WAVE BENCH

ENTIRE BENCH (FRAME INCLUDED)
AVAILABLE ONLY IN ONE THERMOPLASTIC FINISH

LEXINGTON WAVE BENCH

- Customized bench for a specialized look
- Custom lettering is included
- 12 letter spaces maximum for 4' benches
- 18 letter spaces maximum for 6' benches

5 Year Limited Warranty

1275650	4' Portable and/or Surface Mount	\$3,252 ⁹⁹ EA	
1275667	6' Portable and/or Surface Mount	\$4,199 ⁹⁹ EA	

ULTRACOAT™ THERMOPLASTIC COATED BENCHES

- 6' and 8' lengths available
- 12" wide seat
- Diamond and Perforated patterns available
- All welded frame made from 2-3/8" O.D. pipe
- Made in the USA

5 Year Limited Warranty

BENCH WITH BACK SUPPORT					
SIZE	PORTABLE	IN-GROUND	SURFACE MOUNT	PRICE EA.	
6' DIA.	1275759	1275797	1275834	\$1,549 ⁹⁹	
6' PERF.	1275766	1275803	1275841	\$1,649 ⁹⁹	
8' DIA.	1275773	1275810	1275858	\$1,699 ⁹⁹	
8' PERF.	1275780	1275827	1275865	\$1,799 ⁹⁹	



6' BENCH WITH BACK - DIAMOND



6' BENCH - PERFORATED

BENCH WITHOUT BACK SUPPORT					
SIZE	PORTABLE	IN-GROUND	SURFACE MOUNT	PRICE EA.	
6' DIA.	1275872	1275919	1275957	\$1,149 ⁹⁹	
6' PERF.	1275889	1275926	1275964	\$1,249 ⁹⁹	
8' DIA.	1275896	1275933	1275971	\$1,199 ⁹⁹	
8' PERF.	1275902	1275940	1275988	\$1,299 ⁹⁹	



1.



2.



3.

BLEACHER COVERS

- Perfect for providing safety and comfort by protecting spectators from foul balls and excessive sunlight.
- All units feature durable black powder-coated steel posts designed for permanent installation
- Exclusive Shadsure™ cloth covering to block over 90% of harmful UV rays
- Professional installation recommended
- All structures have a 90 MPH windload rating and 5 lb. snowload rating (call for details on higher ratings)
- California public schools must call for DSA information.
- Please allow 6 to 8 weeks for delivery
- All covers carry a 10 year limited warranty with the exception of Red cover which carries a 3 year limited warranty.

1) Slanted Bleacher Covers Front is 10'H and Rear is 13'H

1100662	18' x 26'	\$10,999 ⁹⁹ EA	
1100716	20' x 26'	\$11,999 ⁹⁹ EA	

2) Standard Bleacher Covers

1100617	10'H x 15' x 15'	\$8,999 ⁹⁹ EA	
1100518	10'H x 18' x 27'	\$10,999 ⁹⁹ EA	
1100563	12'H x 18' x 36'	\$13,999 ⁹⁹ EA	

3) Single Post Pyramid

1100860	10' x 10'	\$6,999 ⁹⁹ EA	
1100914	12' x 12'	\$6,999 ⁹⁹ EA	
1100969	14' x 14'	\$8,499 ⁹⁹ EA	



ADA ACCESSIBLE GRILL

- Same specs. as Rotating Flipback Grill
- 3-1/2" post
- ADA accessible at 28" height

1276091	280 sq. inch Cooking Area	\$629 ⁹⁹ EA	
1276107	300 sq. inch Cooking Area	\$649 ⁹⁹ EA	



BI-LEVEL GRILL

- 1008 square inches of cooking area
- Utility shelf, grate adjusts to 4 different levels
- 4" square post
- High temp. powder coat finish

1276114	In-Ground	\$2,199 ⁹⁹ EA	
1276121	Surface Mount	\$2,249 ⁹⁹ EA	



32 GALLON CUSTOM LASER CUT TRASH RECEPTACLE



DOMELID

CUSTOM TRASH RECEPTACLES

1275674	Diamond Pattern	\$1,461 ⁹⁹ EA	
1275681	Perforated	\$1,674 ⁹⁹ EA	



32 GALLON TRASH RECEPTACLE - DIAMOND

32 GALLON TRASH RECEPTACLE - PERFORATED



RAIN BONNET LID

THERMOPLASTIC TRASH RECEPTACLES

- 32 gallon trash receptacle is available in Diamond or Perforated patterns.
- Plastic liner and lids sold separately.
- Available colors: Black, Brown, Green, Dark Blue, Burgundy, Light Blue, Red and Beige.

5 Year Limited Warranty

1275698	Diamond - Specify Color	\$1,374 ⁹⁹ EA	
1275704	Perforated - Specify Color	\$1,559 ⁹⁹ EA	
1275711	Dome Lid - Black	\$319 ⁹⁹ EA	
1275728	Flat Lid (8" Opening) - Specify Color	\$319 ⁹⁹ EA	
1275735	Rain Bonnet - Specify Color	\$359 ⁹⁹ EA	
1275742	Plastic Liner - Black	\$164 ⁹⁹ EA	

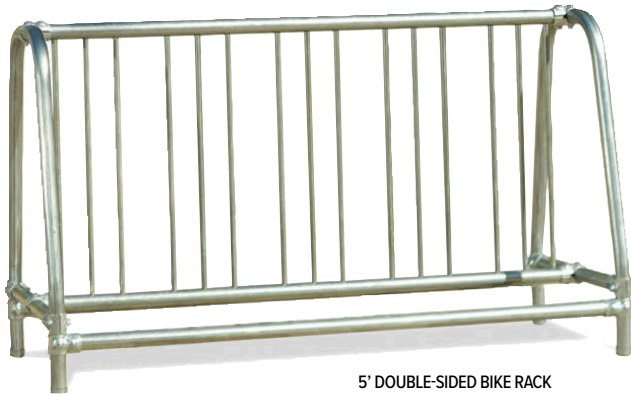

5' DOUBLE-SIDED BIKE RACK

TRADITIONAL BIKE RACKS

- Available as either in-ground, portable or surface mount design (mounting hardware not included)
- Constructed of 1 5/8"OD steel
- 5/8"OD rung bars
- All zinc plated hardware

5 Year Limited Warranty

1375258	5' Single sided - In ground	\$1,099 ⁹⁹ EA	
1375259	5' Single sided - Portable	\$1,049 ⁹⁹ EA	
1375260	5' Single sided - Surface Mount	\$1,189 ⁹⁹ EA	
1375261	8' Single sided - In ground	\$1,249 ⁹⁹ EA	
1375262	8' Single sided - Portable	\$1,199 ⁹⁹ EA	
1375263	8' Single sided - Surface Mount	\$1,349 ⁹⁹ EA	
1375264	10' Single sided - In ground	\$1,349 ⁹⁹ EA	
1375265	10' Single sided - Portable	\$1,299 ⁹⁹ EA	
1375266	10' Single sided - Surface Mount	\$1,449 ⁹⁹ EA	
1375267	5' Double sided - In ground	\$1,159 ⁹⁹ EA	
1375268	5' Double sided - Portable	\$1,119 ⁹⁹ EA	
1375269	5' Double sided - Surface Mount	\$1,199 ⁹⁹ EA	
1375270	8' Double sided - In ground	\$1,349 ⁹⁹ EA	
1375271	8' Double sided - Portable	\$1,299 ⁹⁹ EA	
1375272	8' Double sided - Surface Mount	\$1,399 ⁹⁹ EA	
1375273	10' Double sided - In ground	\$1,549 ⁹⁹ EA	
1375274	10' Double sided - Portable	\$1,499 ⁹⁹ EA	
1375275	10' Double sided - Surface Mount	\$1,599 ⁹⁹ EA	

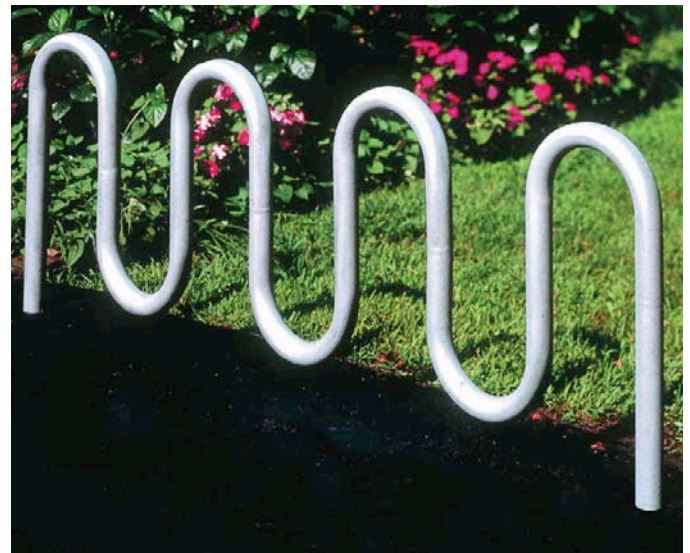

7 Loop Bike Rack

CONTEMPORARY BIKE RACKS

- All one piece - no assembly require
- Comprised of 2 3/8"OD steel tubing
- Available as in ground design or surface mount (mounting hardware not included)

5 Year Limited Warranty

1375247	1 Loop - 2 Bike - In ground design	\$639 ⁹⁹ EA	
1375249	1 Loop - 2 Bike - Surface mount design	\$679 ⁹⁹ EA	
1375250	3 Loop - 5 Bike - In ground design	\$1,089 ⁹⁹ EA	
1375251	3 Loop - 5 Bike - Surface mount design	\$1,199 ⁹⁹ EA	
1375252	5 Loop - 7 Bike - In ground design	\$1,219 ⁹⁹ EA	
1375253	5 Loop - 7 Bike - Surface mount design	\$1,349 ⁹⁹ EA	
1375254	7 Loop - 9 Bike - In ground design	\$1,329 ⁹⁹ EA	
1375255	7 Loop - 9 Bike - Surface mount design	\$1,419 ⁹⁹ EA	
1375256	9 Loop - 11 Bike - In ground design	\$1,629 ⁹⁹ EA	
1375257	9 Loop - 11 Bike - Surface mount design	\$1,719 ⁹⁹ EA	

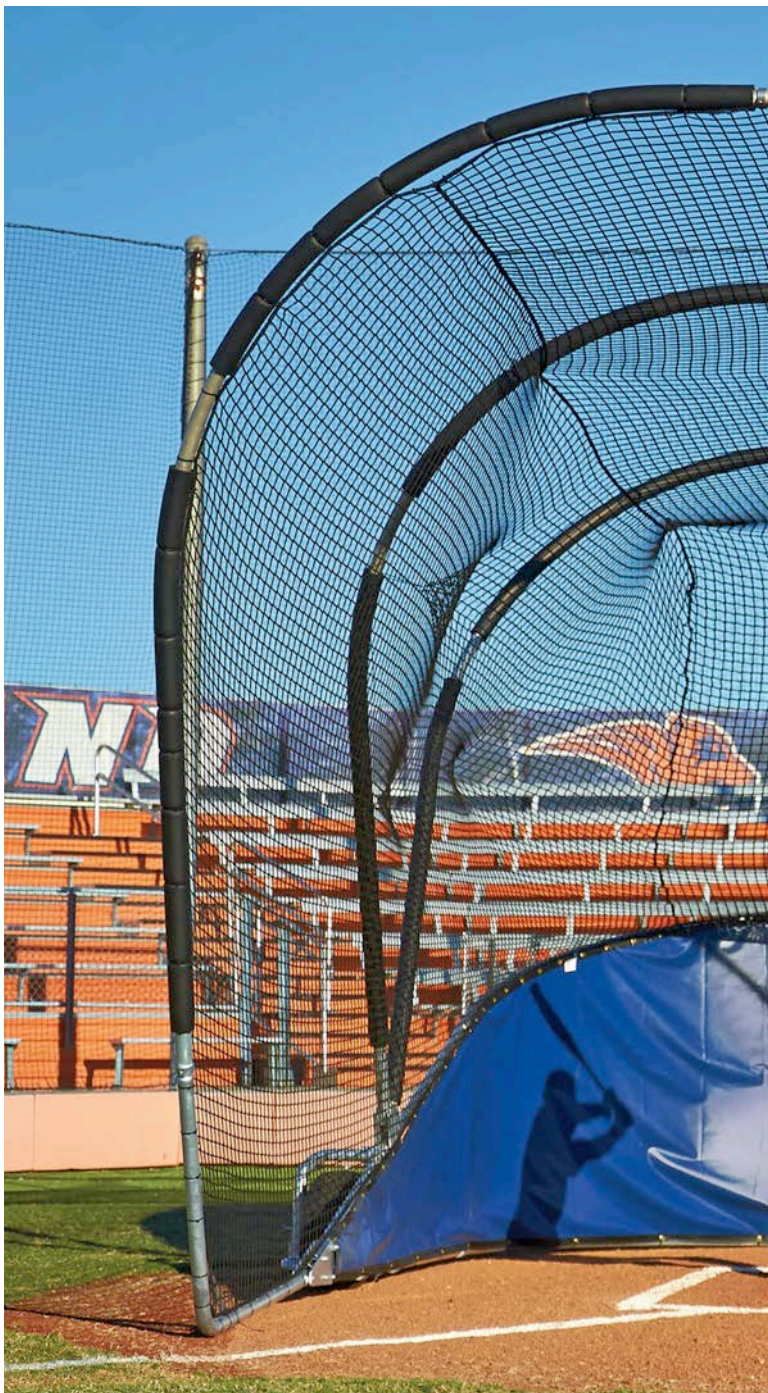

BUBBA ELITE BATTING CAGE



BUBBA ELITE BATTING CAGE

- Dual coaches observation platforms, 8.5"W x 18"H pneumatic tires, premium ricochet padding most frame work, 3.5mm weather-treated EHT net w/extra 10' x 10' baffle net, nylon reinforced 18oz. vinyl skirt, black thud pad w/grommets, and lockable dolly lift system portability
- Constructed of 2" heavy-wall aluminum tubing
- Collapses to only 5' high to limit storage
- Interior Dimensions: 18"W x 22"D x 12"H
- Exterior Width: 20'W
- Thud pad: 68"W x 52"H x 4"D
- Shipping Wt 625 lbs.

STOCK SKIRT COLORS



\$7,499⁹⁹

BSELITE ★ Complete Unit 

\$999⁹⁹

1316681 ★
Replacement Dolley

\$1,599⁹⁹

BIGBUBBANTDS ★
Replacement Net

\$799⁹⁹

BSBSK ★
Replacement Skirt

\$99⁹⁹

1273830 ★
Ricochet Cushion

\$699⁹⁹

1217612DS ★
Thud Pad

BIG BUBBA

PRO BATTING CAGE



\$7,299⁹⁹

BSBUBBA ★ Complete Unit 

BIG BUBBA PRO BATTING CAGE

- Constructed of 2" heavy-wall aluminum tubing, pneumatic tires, 42' of ricochet cushion, 3.5mm weather treated EHT net w/ extra 10'x10' baffle net, 18oz. vinyl skirt and lockable dolley lift system for easy portability.
- Optional thud pad features 18oz. vinyl cover.
- Interior Dims: 18'W x 22'D x 12'H
- Collapses to 19' W X 13.5' D X 5.5' H
- Exterior width: 19'W
- Shipping weight 408 lbs.
- 5 Year Limited Warranty

STOCK SKIRT COLORS



QUICKLY COLLAPSES FOR PORTABILITY & STORAGE

ADDITIONAL OPTIONS		
1273830	Ricochet Cushion - sold in 6' lengths	\$99 ⁹⁹ EA ★
BSBSK	Repl. vinyl skirt (specify color)	\$799 ⁹⁹ EA
1274042	Replacement Dolley	\$999 ⁹⁹ EA ★
BIGBUBBANTDS	Replacement Net with Baffle	\$1,599 ⁹⁹ EA



SAFEOFAM PADDING

- Premium grade padding for fence tops, pipes, rails, around dugouts, etc.
- Pre-slit for easy installation
- Fits completely over any round pipe that is 2-1/8" in diameter
- Secure with 19" tie wraps (sold separately)
- Minimum order of 6 pieces

5 Year Limited Warranty

Color Options: **Black, Blue, Grey, Green, Purple, Red, Yellow.**

1158847

Padding (8' piece)

\$99⁹⁹ EA

K13109

Tie wraps (Black, Green, Yellow)

\$79⁹⁹ 100/SET

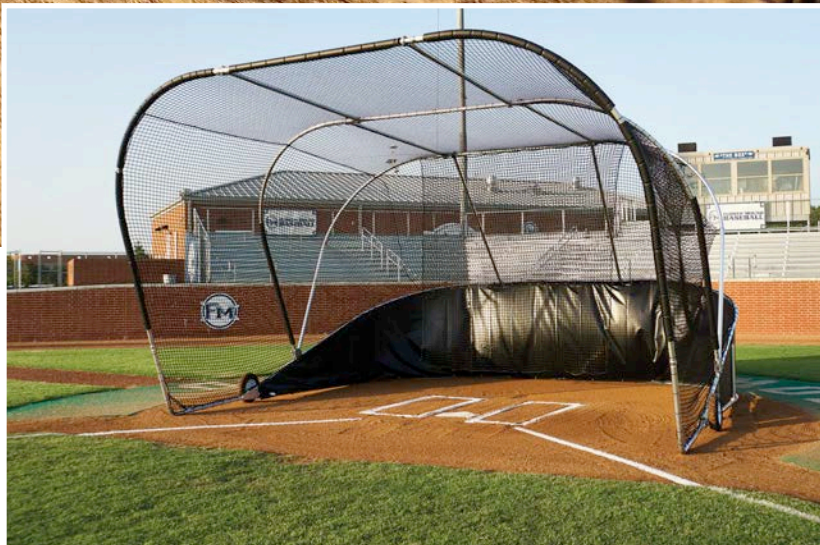

COACH'S VIEWING PLATFORM

- Coaches can now view batting practice from this portable, adjustable stand.
- Constructed of 1 1/2" round aluminum tubing.
- Each stand is 20" wide and 10.5" from the ground.
- The stand will fold for safety and convenient storage.

5 Year Limited Warranty

BSBCPLT

\$619⁹⁹ EA ★



COLLAPSIBLE & PORTABLE

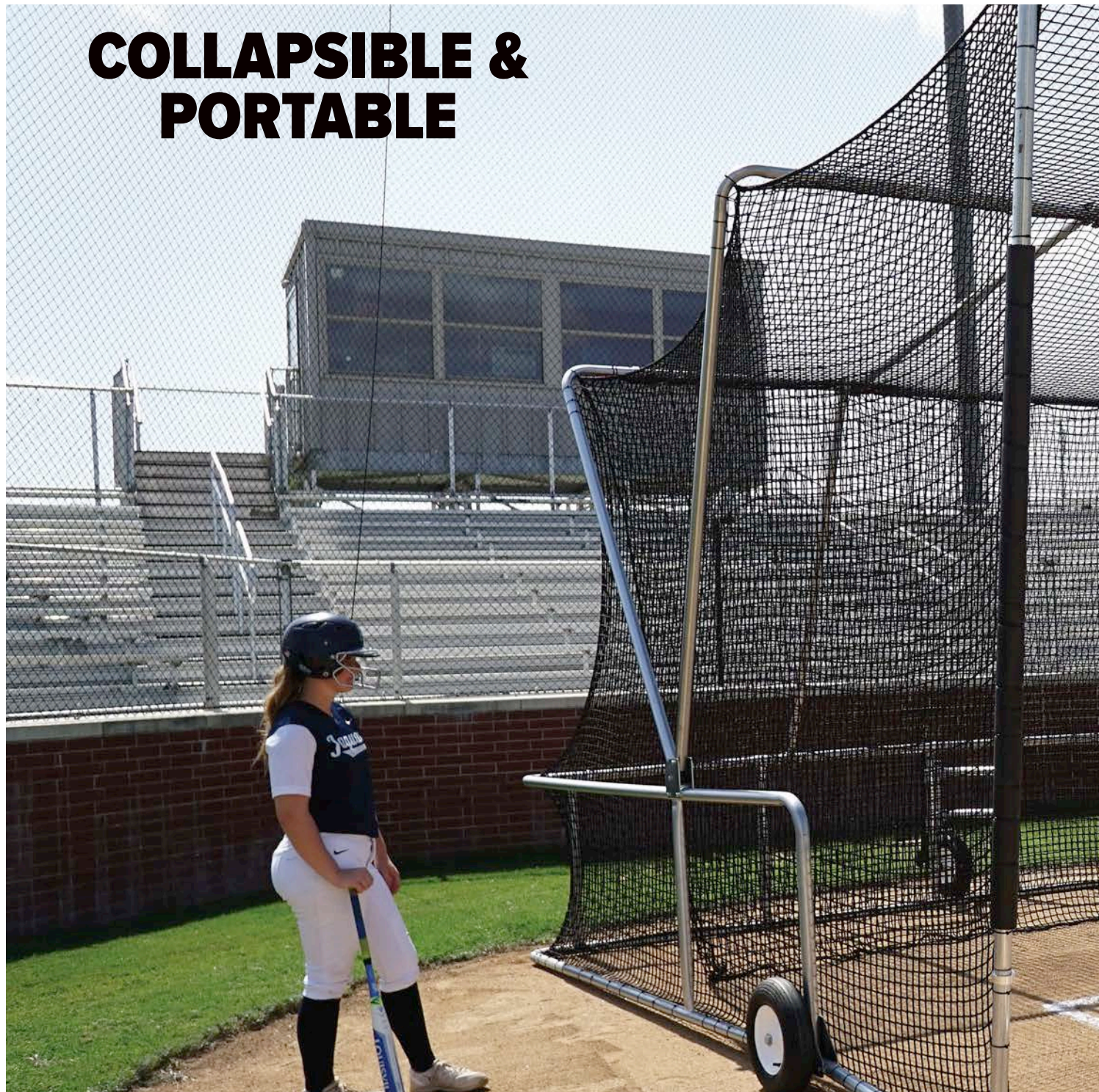

FOLDABLE, PORTABLE BATTING CAGE

- Constructed of 2" O.D. 14 gauge flo-coated galvanized steel
- Features a lockable drolley lift system, three 16"D x 4"W pneumatic tires for easy mobility, 3.5 mm weather-treated EHT net with extra baffle net, 18' of ricochet cushion
- Optional 18 oz. vinyl skirt available for those who want a solid lower backdrop
- Interior dimensions: 16.5'W x 16.5'D x 11'H
- Weight: 650 lbs.

BS4000F
1273830
1274042
1197525

Complete unit
 Ricochet Cushion - sold in 6' lengths
 Replacement Drolley
 Replacement Net only

\$6,299⁹⁹ EA ★ 
~~\$999~~⁹⁹ EA ★
~~\$999~~⁹⁹ EA ★
~~\$1,449~~⁹⁹ EA ★



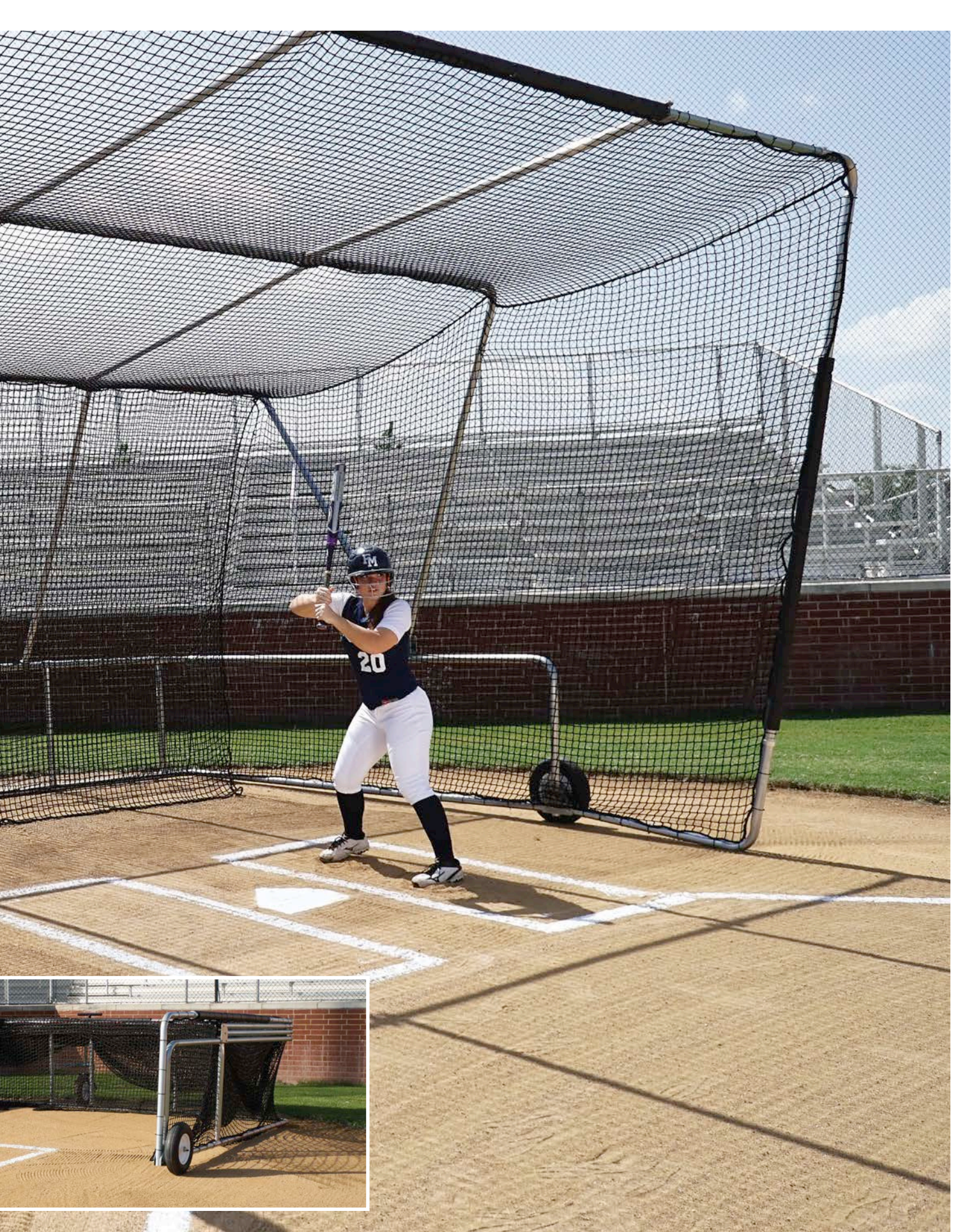

PORTABLE BATTING CAGE

- Constructed of 2" O.D. 14 gauge flo-coated galvanized steel.
- Cage features include: lockable drolley lift system, three 16"D x 4"W pneumatic tires for easy mobility, heavy-duty 3.5 mm weather-treated EHT netting with extra baffle net behind batter.
- Extra width to accommodate left or right hand hitters without shifting the cage.
- Dims: 18"W x 12"D x 12.5'H
- Wt 500 lbs.

BS4000	Complete unit	\$4,999 ⁹⁹	EA ★	
1273830	Ricochet Cushion - sold in 6' lengths	\$99 ⁹⁹	EA ★	
1274042	Replacement Dolley	\$999 ⁹⁹	EA ★	
1197518	Replacement Net only	\$1,449 ⁹⁹	EA ★	



CHAIN LINK BACKSTOPS

- Permanent backstops are erected by installing supplied 2-3/8" pipe supports approximately every 10' in concrete footings
- Then, simply bolt prefabricated 5' x 10' panels in place to create your finished backstop
- 5' x 10' panels are composed of 1-5/16" OD galvanized tubing with center reinforcing brace and 9 gauge galvanized woven wire
- Backstops are extremely durable and allow individual panels to be removed or replacement as needed

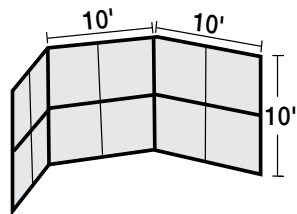

5 Year Limited Warranty

BSCL10	10' - No Hood or Wings	\$3,999 ⁹⁹	SET ★	
BSCL10H	10' w/Hood-No Wings	\$4,599 ⁹⁹	SET ★	
BSCL20	20' - No Hood or Wings	\$4,999 ⁹⁹	SET ★	
BSCL10HW	10' w/Hood & Wings	\$5,499 ⁹⁹	SET ★	
BSCL20H	20' w/Hood-No Wings	\$6,399 ⁹⁹	SET ★	
BSCL20HW	20' w/Hood & Wings	\$7,499 ⁹⁹	SET ★	



BASEBALL HITTING STATION

- 2 3/8" diameter galvanized steel construction
- Installed dimensions - 10'H x 11'W x 1'D
- Can be installed permanently or semi permanent with included ground sleeves
- Turf mat not included - see page 37

3 Year Limited Warranty

BBHITSTA	Complete Unit	\$1,149 ⁹⁹	EA ★	
-----------------	---------------	-----------------------	------	--



PHANTOM INDOOR BATTING CAGE

- 3 reach poles to eliminate the need for ladder
- 3 cam lock pulleys for net adjustments.
- Takes 2 people less than 5 minutes for set up/take down.

1459370	55'L x 14'W x 14'H	\$3,899 ⁹⁹ EA	
1459371	70'L x 14'H x 14'W	\$4,499 ⁹⁹ EA	



MODULAR BATTING TUNNEL FRAME

- 3" OD galvanized steel pipe
- Steel support cables
- Ground cable kit
- Tensioned cuffs - Black only!
- Complete installation instructions
- Complete system includes: poles, net, hardware and cables

1373622	70' Single Tunnel	\$12,499 ⁹⁹ EA	
1373625	70' - Double Tunnel	\$16,499 ⁹⁹ EA	
1373624	55' - Single Tunnel	\$9,499 ⁹⁹ EA	
1373623	55' Double Tunnel	\$17,999 ⁹⁹ EA	



BATTING CAGE DOOR

- All steel frame - easy to assemble
- Free standing door
- Lacing rope included
- Door size: 30 1/2"W x 72 1/2"H
- Door frame: 33 3/4"W x 76 1/2"H
- Weight 35 lbs.

K50651	\$449 ⁹⁹ EA
--------	------------------------

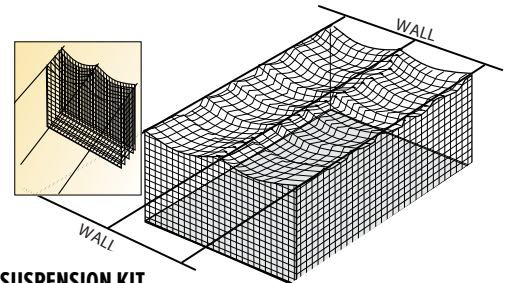

INDOOR WALL TO WALL SUSPENSION KIT

- Includes everything you need to suspend a batting cage tunnel between two walls inside a gym or training facility (net not included)

1236637	\$589 ⁹⁹ EA
---------	------------------------

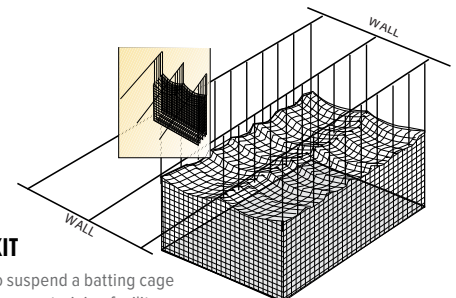

CEILING NET SUSPENSION KIT

- Includes everything you need to suspend a batting cage tunnel from the ceiling inside a gym or training facility (net not included)

1236644	\$799 ⁹⁹ EA
---------	------------------------

VARSITY TUNNEL FRAMES

COACH'S CHOICE



VARSITY TUNNEL FRAMES

- Constructed of 2" round, 13 gauge galvanized steel powder coated black tubing
- System includes upright poles, cross member, ground sleeves, cable, clamps, eyebolts, turnbuckle and snap rings
- Fits all cages up to 14' W and 12' H
- Frame size after installation is 16' W x 12' H
- Net will hang at 11' - allowing 1" on the ground to contain balls

- Recommend: Collegiate Series Tunnel Nets - sold separately
- 3 Section frame for nets 55' and shorter
- 4 Section frame for nets 70' and longer

BS10000
BS10004
BBFRMHDW

3 Section Frame
4 Section Frame
Replacement Hardware Only

\$2,249⁹⁹ EA ★ **S&H**
\$2,479⁹⁹ EA ★ **S&H**
\$449⁹⁹ EA ★

PRO TUNNEL FRAMES



Shown with Turf Roll (sold separately)

PRO TUNNEL FRAME

- Super-Duty 3.5" OD 13-gauge galvanized steel pipe
- Available in surface mount, in ground and semi-permanent (with use of optional ground sleeves)
- Includes steel cable, clamp, turn buckles and quick links
- Complete installation instructions and hardware included
- 16'W x 11.5'H

5 Year Limited Warranty

1253634 3 Section Frame - Surface Mount
1274639 4 Section Frame - Surface Mount
1375091 3 Section Frame - In Ground
1375092 4 Section Frame - In Ground
1375093 Ground sleeves (optional)

\$4,149⁹⁹ EA ★ **S&H**
\$5,149⁹⁹ EA ★ **S&H**
\$3,899⁹⁹ EA ★ **S&H**
\$4,999⁹⁹ EA ★ **S&H**
\$189⁹⁹ PR ★

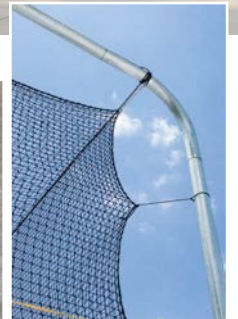



Gold Medal
ATHLETIC PRODUCTS

**QUALITY. DURABILITY.
CRAFTSMANSHIP.**

OVER 125 YEARS



ALL-STAR TUNNELS

- 3.5mm, 1-3/4" black nylon netting
- 36 thread twisted knotted
- 380 lb. breaking test
- Nyothene weather treatment for outdoor use
- Durable vinyl border
- Includes 14' x 12' backing to resist net wear behind batter
- Includes three full-length ropes to prevent sagging

1245059DS	55'L x 14'W x 12'H	\$3,099 ⁹⁹	EA ★	
1245042DS	70'L x 12'W x 12'H	\$3,299 ⁹⁹	EA ★	
1245035DS	70'L x 14'W x 12'H	\$3,399 ⁹⁹	EA ★	

COLLEGIATE SERIES TUNNELS

- 2.0mm #24 twisted knotted polyethylene
- 185 lb. breaking strength
- UV treated - 100% waterproof
- 2mm size 1 3/4 square mesh
- For indoor or outdoor use
- Same great features as Pro Series tunnels, but for those on a tighter budget

1149388	70'L x 14'W x 12'H	\$1,749 ⁹⁹	EA ★	
1149401	70'L x 12'W x 12'H	\$1,699 ⁹⁹	EA ★	
1241044	55'L x 14'W x 14'H	\$1,599 ⁹⁹	EA ★	
1149395	55'L x 14'W x 12'H	\$1,499 ⁹⁹	EA ★	
1241037	35'L x 14'W x 12'H	\$1,249 ⁹⁹	EA ★	

PRO SERIES TUNNELS

- 2.5mm #42 twisted knotted polyethylene
- 225 lb. breaking strength
- 100% water proof and UV treated
- Extruded permanent black color
- 1 3/4" square mesh
- Three ropes running lengthwise on top and all 4 corners for "no sag" net system

1149340	70'L x 14'W x 12'H	\$1,999 ⁹⁹	EA ★	
1149357	70'L x 12'W x 12'H	\$1,899 ⁹⁹	EA ★	
1242478	55'L x 14'W x 14'H	\$1,799 ⁹⁹	EA ★	
1149371	55'L x 14'W x 12'H	\$1,699 ⁹⁹	EA ★	
1149364	55'L x 12'W x 12'H	\$1,599 ⁹⁹	EA ★	

NET SAVERS



TUNNEL/CAGE SAVERS

- Heavy duty reinforced vinyl tarp to protect the netting in your batting cage
- Includes grommets and corner ropes
- Size - 5'W x 7'H

1236651	22 oz. vinyl w/ White Target	\$419 ⁹⁹	EA
1269918	30 oz. Black w/ Orange Target	\$419 ⁹⁹	EA
1269925	30 oz. Navy w/ Yellow Target	\$419 ⁹⁹	EA



BATTING TUNNEL NET PROTECTOR PAD

- Protect your tunnel with this vinyl covered backstop pad
- Perfect for any indoor or outdoor batting cage
- Size - 3'W x 4'H x 1-1/2" thick

200180453DS	\$349 ⁹⁹	EA
--------------------	---------------------	----



VINYL BACKDROP WITH TARGET

- Constructed of heavy duty 40oz. vinyl with white strike zone.
- Strike zone is 18"W x 30"H

1323467	Size - 5'W x 6'H	\$269 ⁹⁹	EA
----------------	------------------	---------------------	----



- Heavy-duty 11/2" square 17 gauge galvanized steel
- Fames are 7' H x 7' W
- 2.5mm twisted knotted polyethylene slip-on pillow case style net



L- SCREEN

1399586 Complete Unit \$629.99 EA ★ 
1148657 Replacement Net \$249.99 EA ★



SOCK NET

1399587 Complete Unit \$719.99 EA ★ 
1148695 Replacement Net \$299.99 EA ★



SOFTBALL PITCHERS PROTECTOR

1399588 Complete Unit \$619.99 EA ★ 
1148718 Replacement Net \$299.99 EA ★



FIRST BASE/FUNGO PROTECTOR

1399589 Complete Unit \$649.99 EA ★ 
1148671 Replacement Net \$219.99 EA ★



C-SHAPED SOFTBALL PITCHERS PROTECTOR

1453177 Complete Unit \$579.99 EA ★ 
1366836N Replacement Net \$279.99 EA ★



L-SCREEN W/ HOOD

1453178 Complete Unit \$729.99 EA ★ 
1378703 Replacement Net \$349.99 EA ★

- Oversized for maximum protection
- Heavy wall construction
- Slip-over pillow case (3.0 mm) NYLON NET INCLUDED
- 10" NO flat tires for easy transporting



BASE/FUNGO SCREENS

BSFPRO10	Complete Unit - 10' x 10'	\$1,489 ⁹⁹	EA ★	
1148619	Replacement Net - 10'H x 10'W	\$389 ⁹⁹	EA ★	
BSFPRO8	Complete Unit - 8' x 8'	\$1,349 ⁹⁹	EA ★	
1148596	Replacement Net - 8'H x 8'W	\$389 ⁹⁹	EA ★	



MINI PRO L-SCREEN

BSFPRO5	Complete Unit (5' x 7' - on field)	\$999 ⁹⁹	EA ★	
1296464	Replacement Net	\$299 ⁹⁹	EA ★	
1378702	Complete padding option for Mini L Screen	\$219 ⁹⁹	EA ★	



TRI-FOLD FUNGO SCREEN

BSFPRO16	Complete Unit - 8'H x 16'W	\$1,899 ⁹⁹	EA ★	
1148596	Replacement Net - Middle Section	\$389 ⁹⁹	EA ★	
1265279	Replacement Net - Side Wings (pair)	\$429 ⁹⁹	PR ★	



PRO L-SCREEN

BSPROL	Complete Unit - 8' x 8' - Aluminum (on field)	\$1,599 ⁹⁹	EA ★	
BSPROLS	Complete Unit - 8' x 8' - Steel (on field or in tunnel)	\$1,599 ⁹⁹	EA ★	
1148572	Replacement Net - 8' x 8'	\$389 ⁹⁹	EA ★	
1378694	Complete padding option for L-Screen	\$219 ⁹⁹	EA ★	



WORLD-CLASS WINDSCREENS

TUFFY® WINDSCREENS

Our proprietary Tuffy® Windscreens is the only windscreen featuring lock-stitch finishing to assure that it's sides and corners do not unravel.

- Made with Vipol® Matrix 10 oz material, a super-durable mesh fabric of tightly woven micro fibers
- Sun UV resistance and mildew inhibitor protected
- Virtually tear proof and has the highest puncture and tear resistance
- Allow 22% wind pass-through, 78% shade factor
- Grommets every 12" on all 4 sides
- 9' model complete w/half moon vents
- 5 year limited warranty

WITHOUT PRINTING

1323566	up to 5'H	\$1 ⁹⁹	SO.FT
1285598	6'H	\$2 ⁴⁹	SO.FT
1285604	9'H	\$2 ⁹⁹	SO.FT

WITH DIGITAL IMPRINTING

1452960	up to 5'H	\$10 ⁹⁹	SO.FT
1452961	6'H	\$10 ⁹⁹	SO.FT
1452962	9'H	\$10 ⁹⁹	SO.FT

WINDSCREEN ACCESSORIES

1298253	Boxed Air Vent	\$19 ⁹⁹	EA
MITWRAPS	7" Tie Wraps (50 lbs. brk strength - pk of 100)	\$52 ⁹⁹	PACK

COLOR AVAILABILITY FOR VIPOL MATRIX WINDSCREENS

BLACK	WHITE	BROWN	BURNT ORANGE	TROPICAL ORANGE	VEGAS GOLD	GOLD	BEIGE	YELLOW
KELLY GREEN	AQUA	CC SKY BLUE	ROYAL BLUE	PRO BLUE	NAVY BLUE	PURPLE	RED	SCARLET
GREY	FOREST GREEN	MIDNIGHT GREEN	MAROON	DK SPORTS GREY				

Ask About Our Innovative Closed-mesh Technology



QUALITY • DURABILITY • CRAFTSMANSHIP



**BSN SPORTS[™]
POLYESTER WINDSCREEN**

- 8oz. weight/sq. yard construction, 84% shade factor, maximum UV protection
- Custom cut to any size
- Brass tooth grommets spaced every 18" on all four sides
- IncrediSeal - eliminates all sewing and stitching
- 9' comes standard with lacing lip and half moon vents
- Match school logos exactly-digitally printed directly from your image file
- State of the art digital printing with unlimited color options

Without Printing

1393784	up to 5'H	\$1 ²³ SQ.FT
1393785	6'H	\$1 ²⁷ SQ.FT
1393786	9'H	\$1 ²⁹ SQ.FT

With Printing

1398129	up to 5'H	\$7 ⁴⁹ SQ.FT
1398130	6'H	\$7 ⁴⁹ SQ.FT
1398131	9'H	\$7 ⁴⁹ SQ.FT



POLY AND ARMORMESH WINDSCREEN ACCESSORIES

1397737	Boxed Vent	\$19 ⁹⁹ EA
1397738	Lacing Lip	\$0 ¹⁰ EA
MTTWRAPS	7" Tie Wraps (50 lbs. brk strength - pk of 100)	\$52 ⁹⁹ PACK



ARMORMESH WINDSCREEN

- Features 14 oz. woven, extrusionvinyl-coated polyester
- Excellent tear strength and outstanding abrasion resistance
- Fabricated with IncrediSeal technology
- 75% shade factor
- Lacing lip and half moon vents standard on screens over 6'
- Match school logos exactly-digitally printed directly from your image file
- State of the art digital printing with unlimited color options

Without Printing

1393787	up to 5'H	\$1 ¹⁷ SQ.FT
1393788	6'H	\$1 ²³ SQ.FT
1393789	9'H	\$1 ²⁹ SQ.FT

With Printing

1398132	up to 5'H	\$8 ⁴⁹ SQ.FT
1398133	6'H	\$8 ⁴⁹ SQ.FT
1398134	9'H	\$8 ⁴⁹ SQ.FT

6 YEAR LIMITED WARRANTY



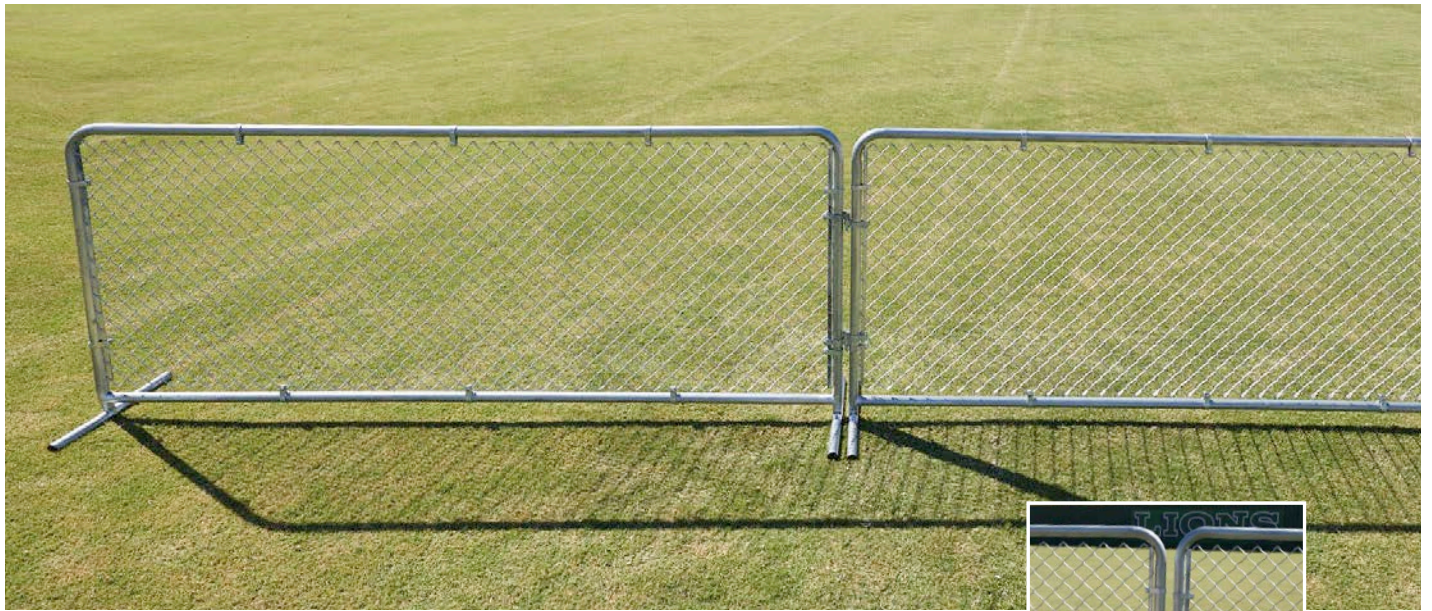

PORTABLE CHAIN LINK FENCE PANELS

- Heavy duty portable chain link fence panels 4'H x 10'L can be used for home run, sideline, crowd control fencing, etc.
- Constructed of galvanized steel frame with 11 gauge chain link fabric
- Legs pivot for storage
- Supplied with connectors to secure panels together
- Weight: 62 lbs. per panel
- Actual freight charges apply
- Minimum purchase of 5 panels

BS10680

\$549⁹⁹ EA ★ 

SAF TOP FENCE GUARD

- Teardrop shaped UV treated HDPE
 - Pre-drilled holes every 24"
 - Packed 10 sections
 - 2"W x 4"T x 7'L = 84' per carton
 - 1-Year Limited Warranty
 - Available Colors: Red, Green, Yellow
- Color Options: **Green, Red, Yellow.**

1459340

Specify Color

\$259⁹⁹ SET OF 10



DELUX FENCE TOP RAIL PADDING

- Provides superior appearance and protection on the top of chain link and outfield fences.
- 2" thick foam is encased in 18 oz. vinyl w/ grommets for attachment.
- Fits up to 2 1/2" pipe

K14065

6' section

\$159⁹⁹ EA



FENCE GUARD

- Installed over your chain link fence adds safety and reduces player injuries
- Increases visibility
- Beautifies any field
- Weather treated and UV protected
- 4-1/2" in diameter
- Actual freight charges apply



BBPC100X	Yellow 100'	\$299⁹⁹ ROLL	
BBPC250X	Yellow 250'	\$399⁹⁹ ROLL	
5POLYINST	Fence Guard Installation Tool	\$139⁹⁹ EA	



FENCE CROWN

- An economical way to increase safety
- Reduce player injuries and increasing visibility
- Weather treated and UV protected
- Slit and ready for easy installation with matching tie wraps every 3'
- Tie wraps NOT included
- Actual freight charges apply



1196726	Bright Yellow - 100'	\$299⁹⁹ ROLL	
1196733	Bright Yellow - 250'	\$399⁹⁹ ROLL	
1269949	Black - 100'	\$299⁹⁹ ROLL	
1269932	Black - 250'	\$399⁹⁹ ROLL	
1196764	Yellow - 19" tie wraps - 100 per pack	\$99⁹⁹ PACK	
1269956	Black - 19" tie wraps 100 per pack	\$99⁹⁹ PACK	

**BLACK & YELLOW
TIE WRAPS
SOLD SEPARATELY**

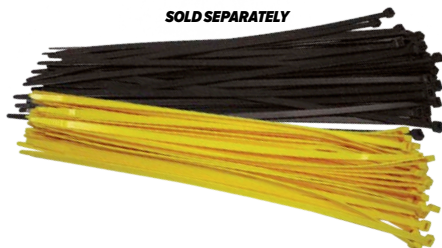



PORTABLE OUTFIELD FENCING

Durable polyethylene square mesh fencing, ideal for use as a stand alone outfield fence when combined with the Smartpole staking system. Rolls are 48”H x 150’L. Sold as packages that include fence rolls, poles and socket.

Specify fence color: **Blue, Dark Green, Scarlet**

COMPLETE OUTFIELD PACKAGE

Includes:

- 150’ of fencing (specify color)
- 16 - 60” smartpoles (2 anchor poles + 14 flexible poles)
- 16 - 12” ground sockets with caps
- Punch-pilot hole tool
- Socket setter and installation sheet

Color Options: **Blue, Dark Green, Scarlet.**

MKGMF6S Specify Color \$699⁹⁹ SET

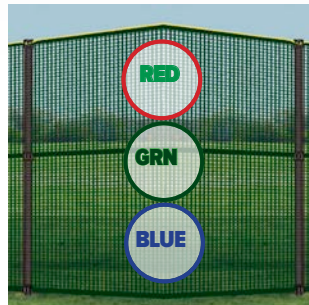

OUTFIELD PACKAGE WITHOUT GROUND SOCKETS

Includes:

- 150’ of Fencing (specify color)
- 16 - 60” SmartPoles (2 anchor poles + 14 flexible poles)
- Punch-pilot hole tool
- Socket setter and installation sheet

Color Options: **Blue, Dark Green, Scarlet.**

MKGMF5S \$629⁹⁹ SET

SMART POLES WITH GROUND SOCKET KIT

- 16 - 60” SmartPoles (14 flex + 2 anchor)
- 16 - 12” ground sockets
- Punch pilot hole tool
- Socket setter
- 160’ yellow poly rope
- 50 tie wraps for added stability

MK16SP60 \$449⁹⁹ SET

SMART POLE ONLY KIT

- 16 - 60” SmartPoles (14 flex + 2 anchor)
- Pilot hole
- 160’ yellow poly rope
- 50 tie wraps for added stability

MK16SSCP \$389⁹⁹ SET

SMARTPOLE FLEXIBLE POLE

- Replacement flexible SmartPole

MKFS60 Black \$36⁹⁹ EA

SMARTPOLE REINFORCED ANCHOR POLE

- Replacement anchor pole

MKRS60 White \$37⁹⁹ EA



16 SMARTPOLE GROUND SOCKETS

- Optional set of 32 ground sleeves and caps for 200’ homerun Enduro fence system.

MK16GS12CP 16 Optional Ground Sockets with Caps \$349⁹⁹ SET

GROUND SOCKET WITH CAP

- Permanently install ground sockets for quick and easy fence installation and tear down

MKGS12 \$17⁹⁹ EA

FENCING ONLY

- 48”H x 150’L fence only
- Color Options: **Blue, Dark Green, Scarlet.**

1196788 specify color \$299⁹⁹ ROLL ★

HOW MUCH OUTFIELD FENCE DO YOU NEED?

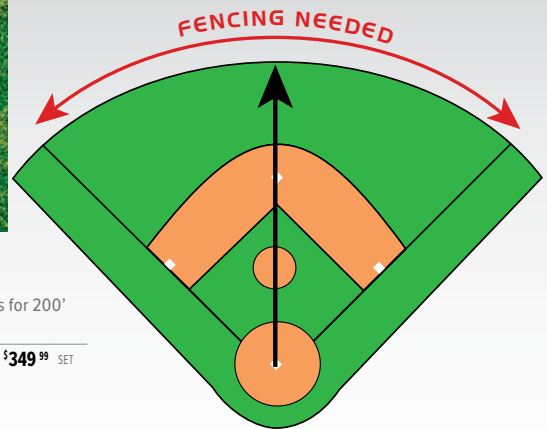

HOME PLATE TO CENTER FIELD

FENCING NEEDED

180'	282.6'
200'	314'
225'	353.25'
250'	392.5'
275'	431.75'
300'	471'
325'	510.25'
350'	549.5'
400'	628'

ENDURO FENCING WITH YELLOW TOP TAPE

Sets a new standard for **Simplicity, Durability and Appearance.** Simply slide the poles through the permanent vinyl pockets in the mesh fencing and drive the pole into the turf with a rubber mallet. No ropes, ties, clips, hooks, etc. The vinyl pockets, spaced every 10', create an attachment to the pole that is uniform top to bottom. Steel pilot hole tool is included for hard ground. Optional ground sockets available. Color Options: **Dark Green, Red, Royal.**

ENDURO FENCING OUTFIELD PACKAGES

Packages include:

- Enduro fence w/pole pockets
- Two (2) white Enduro anchor poles (MKREP1)
- Heavy-duty Enduro flex poles (MKWEP1)
- Steel pilot hole tool

Color Options: **Blue, Dark Green, Red.**

BSF50BP	50'L Fence with 6 Poles	\$499⁹⁹ SET
BSF150BP	150'L Fence with 16 Poles	\$999⁹⁹ SET

200' HOMERUN FENCE PACKAGE

Package includes:

- 314' of Enduro fence
- 32 Enduro poles
- Pilot-hole tool
- Measuring tape
- Optional ground sockets not included (see below)
- Dark Green only

BS314GP	Complete Package	\$2,299⁹⁹ EA
BS13516	32 Optional Ground Sockets and Caps	\$199⁹⁹ PACK ★

300' HOMERUN FENCE PACKAGE

Package includes:

- 471' of Enduro fence
- 48 Enduro poles
- Pilot-hole tool
- Measuring tape
- Optional ground sockets not included (see below)
- Dark Green only

1335941	Complete Package	\$2,849⁹⁹ PACK ★
BS13518	48 Optional Ground Sockets and Caps	\$299⁹⁹ KIT

ENDURO FENCE ONLY

- Replacement fence only
- Please specify color

Color Options: **Dark Green, Red, Royal.**

1236897	50' - Roll only	\$329⁹⁹ EA ★
1236927	150' - Roll Only	\$749⁹⁹ EA ★

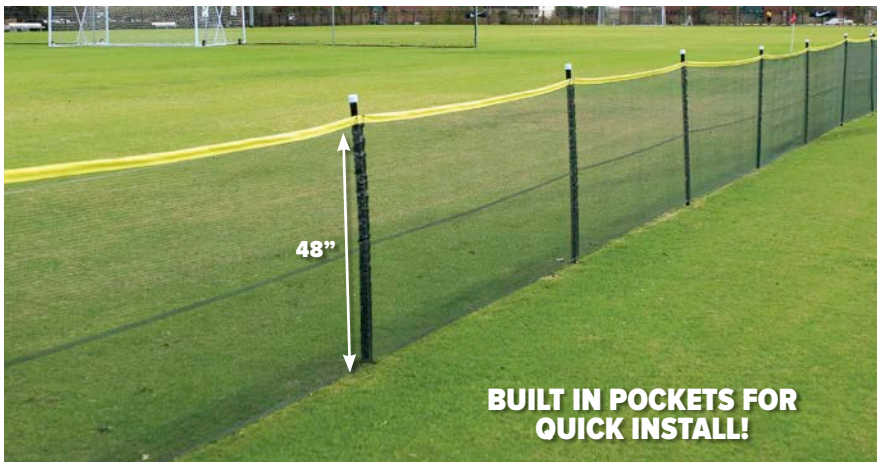

BUILT IN POCKETS FOR QUICK INSTALL!

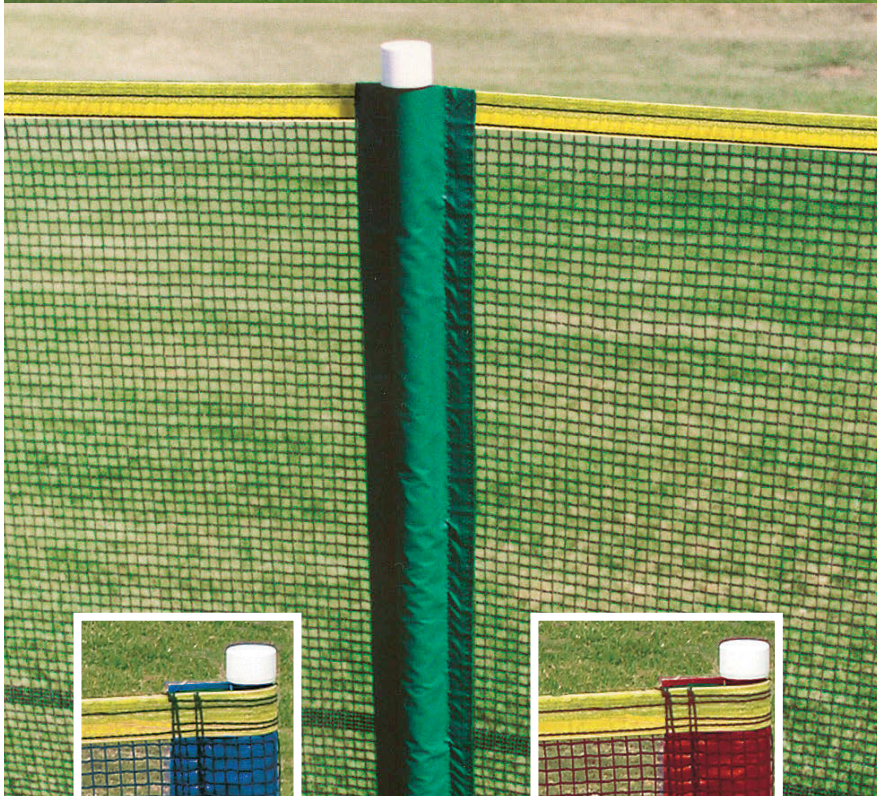

ACCESSORIES

Additional Enduro Poles available for extra stability or replacement.



ENDURO FLEXIBLE POLES

- Replacement flex poles

MKWEP1		\$37⁹⁹ EA
MKWEP16	Set of 16 (14 Flex + 2 Anchor Poles)	\$349⁹⁹ SET

ENDURO ANCHOR POLE

- Reinforced with metal rod to anchor the Enduro fence system

MKREP1	Color: White only	\$37⁹⁹ EA
---------------	-------------------	-----------------------------

GROUND SOCKET WITH CAP

- Permanently install ground sockets for quick and easy fence installation and tear down

MKGS12	\$17⁹⁹ EA
---------------	-----------------------------

GROUND SOCKET CAPS

- 12 pack of plugs for MarkSmart ground sockets
- Use color coded cap for multiple field configurations

MKA103Y	Caps Only - Specify Color	\$21⁹⁹ OZN
----------------	---------------------------	------------------------------

GROUND SOCKET SETTERS - ONE PAIR

- Designed to be placed in the ground socket so you can hit these instead of the ground socket directly

MKA106	\$7⁴⁹ PR
---------------	----------------------------



CUSTOM NETTING









Rope Border



Vinyl Border w/Grommets

PROFESSIONAL #42 THREAD NETTING		
	KNOTTED	KNOTLESS
CONSTRUCTION	#42 Knotted	#42 Knotless
BREAK STRENGTH (approximate)	435 lbs.	337 lbs.
TREATMENT	UV dyed and protected	UV dyed and protected
CODE	1462266	1462268
PRICE	\$1 ²³ SQ.FT	\$1 ⁰⁹ SQ.FT

PROFESSIONAL #36 THREAD NETTING		
	KNOTTED	KNOTLESS
CONSTRUCTION	#36 Knotted	#36 Knotless
BREAK STRENGTH (approximate)	365 lbs.	306 lbs.
TREATMENT	UV dyed and protected	UV dyed and protected
CODE	1462267	1462269
PRICE	\$1 ²³ SQ.FT	\$1 ⁰⁹ SQ.FT

WHICH CUSTOM NET DO YOU NEED?				
TWINE SIZE	ALL-STAR	MVP	MAJOR LEAGUE	VARSITY
CONSTRUCTION	#36 Nylon Twisted-Knotted	3.5 mm Enduro Hybrid Thread Braided-Knotless	3.0 mm Enduro Hybrid Thread Braided-Knotless	2.4 mm Enduro Hybrid Thread Braided-Knotless
BREAK STRENGTH (approximate)	380 lbs.	320 lbs.	275 lbs.	195 lbs.
TREATMENT	Additional UV treatment and black color	Extruded thread with built in UV treatment, weather protection and Black color. Weather Proof, Mold and Mildew Resistant	Extruded thread with built in UV treatment, weather protection and Black color. Weather Proof, Mold and Mildew Resistant	Extruded thread with built in UV treatment, weather protection and Black color. Weather Proof, Mold and Mildew Resistant
WT / SQ FT	.040	.050	.036	.023
CODE	1238525	1188059	8042BKRD5	8066BKRD5
PRICE	\$1 ²³ SQ.FT	\$1 ⁰⁹ SQ.FT	\$1 ⁰³ SQ.FT	\$0 ⁹⁹ SQ.FT

BOUNDARY NETTING



NET REPAIR/LACING CORDS

• Black poly twine

1236743	100' Spool - 3mm	\$39 ⁹⁹ SPOOL ★
1236750	500' Spool - 3mm	\$49 ⁹⁹ SPOOL ★

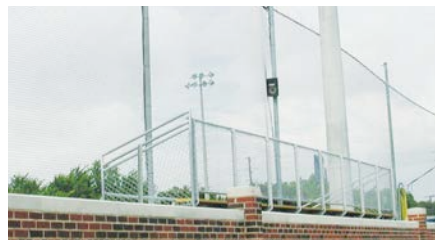

BAFFLE/DIVIDER NET WITH ROPE BORDER

• 2.5mm #42 thread twisted knotted polyethylene
• Net can be hung inside your batting cage to divide it or act as a double back

1236705	Net Size - 12' x 14'	\$279 ⁹⁹ EA ★
----------------	----------------------	--------------------------



PRE-CUT BOUNDARY/PROTECTIVE NETTING

• 1-3/4" mesh, weather treated Varsity (#420) EHT black knotless netting
• Netting is UV resistant
• Heavy overlock stitched rope border
• All panels are rectangular in shape

1236576	Net Size 10' x 30'	\$299 ⁹⁹ EA ★
1236583	Net Size 12' x 50'	\$499 ⁹⁹ EA ★
1236590	Net Size 14' x 50'	\$699 ⁹⁹ EA ★
1236606	Net Size 14' x 100'	\$1,299 ⁹⁹ EA ★



PROFESSIONAL FOUL POLES (3 1/2" OD POLES)

- Constructed of 3.5" OD 13 gauge heavy duty steel
- Powder coated optic yellow
- Easy to see day or night
- Professional 18"W expanded metal wing
- Sold in pairs

BSFOUL	20' Above Ground, 12' Wing, Weight: 362 lbs/pr.	\$2,399 ⁹⁹ PR ★	
BSFOUL15	15' Above Ground, 8' Wing, Weight: 272 lbs/pr.	\$1,999 ⁹⁹ PR ★	
BSFOUL12	12' Above Ground, 6' Wing, Weight: 220 lbs/pr.	\$1,599 ⁹⁹ PR ★	

GROUND SLEEVES FOR 3 1/2" OD FOUL POLES

1255294	48" Ground Sleeves for BSFOUL	\$499 ⁹⁹ PR ★
1255287	36" Ground Sleeves for BSFOUL15 or BSFOUL12	\$449 ⁹⁹ PR ★

FOUL POLES

- Made of two sections that bolt together
- Sold in pairs
- Color Options: White, Optic Yellow, Optic Orange.
- Constructed of heavy-duty steel pipe
- Durable powder coated finish

40' IN GROUND

PR334040C	Specify Color	\$15,999 ⁹⁹ PR	
-----------	---------------	---------------------------	--

32' IN GROUND

PR334032C	Specify Color	\$10,299 ⁹⁹ PR	
-----------	---------------	---------------------------	--

24' IN GROUND

PR334024C	Specify Color	\$7,199 ⁹⁹ PR	
-----------	---------------	--------------------------	--

16' IN GROUND

PR334016C	Specify Color	\$2,699 ⁹⁹ PR	
-----------	---------------	--------------------------	--

12' IN GROUND

PR334012C	Specify Color	\$499 ⁹⁹ PR	
-----------	---------------	------------------------	--

40' SURFACE MOUNT

PR334140C	Specify Color	\$16,999 ⁹⁹ PR	
-----------	---------------	---------------------------	--

32' SURFACE MOUNT

PR334132C	Specify Color	\$11,999 ⁹⁹ PR	
-----------	---------------	---------------------------	--

24' SURFACE MOUNT

PR334124C	Specify Color	\$8,499 ⁹⁹ PR	
-----------	---------------	--------------------------	--



STANDARD FOLDING BACKSTOP PADDING

- 2" polyfoam covered by heavy duty 18 oz. vinyl
- Pads are made to fold in 2'W panels for storage and shipping
- Grommets along all 4 sides for easy of anchoring
- Order with digital printing to dress up your facility

WITHOUT PRINTING

1397739	3'H x 6'L - Weighs 12 lbs.	\$629 ⁹⁹ EA	
1397753	3'H x 8'L - Weighs 16 lbs.	\$679 ⁹⁹ EA	
1397767	3'H x 10'L - Weighs 20 lbs.	\$739 ⁹⁹ EA	
1397781	3'H x 12'L - Weighs 24 lbs.	\$849 ⁹⁹ EA	
1397795	4'H x 6'L - Weighs 16 lbs.	\$729 ⁹⁹ EA	
1397809	4'H x 8'L - Weighs 20 lbs.	\$749 ⁹⁹ EA	
1397823	4'H x 10'L - Weighs 25 lbs.	\$849 ⁹⁹ EA	
1397838	4'H x 12'L - Weighs 30 lbs.	\$949 ⁹⁹ EA	

WITH PRINTING

1397852	3'H x 6'L - Weighs 12 lbs.	\$669 ⁹⁹ EA	
1397866	3'H x 8'L - Weighs 16 lbs.	\$799 ⁹⁹ EA	
1397880	3'H x 10'L - Weighs 20 lbs.	\$969 ⁹⁹ EA	
1397894	3'H x 12'L - Weighs 24 lbs.	\$1,129 ⁹⁹ EA	
1397908	4'H x 6'L - Weighs 16 lbs.	\$829 ⁹⁹ EA	
1397922	4'H x 8'L - Weighs 20 lbs.	\$969 ⁹⁹ EA	
1397936	4'H x 10'L - Weighs 25 lbs.	\$1,249 ⁹⁹ EA	
1397950	4'H x 12'L - Weighs 30 lbs.	\$1,429 ⁹⁹ EA	



BACKSTOP PADDING

- Designed for use on chain-link fencing or cement
 - Features heavy-duty 18 oz. vinyl construction
 - 4" open cell form padding for true ball rebound
 - Grommets are exposed on all 4 sides for ease of attachment
 - Upgrade to printed padding for that "WOW" factor
- Color Options: **Black, Gray, Kelly, Maple Green, Maroon, Navy, Orange, Purple, Red, Royal, Sky Blue, Tan, White, Yellow.**

1398099	Without Printing	\$54 ⁹⁹ SO FT
1398114	With Printing	\$62 ⁹⁹ SO FT





FULL FIELD TARP/COVER

- Constructed of 6 oz woven, 12ml thick polyethylene
- Double-stitched on all four sides with brass grommets placed evenly around the perimeter every 10-12 feet
- Reinforced corners
- Web handles evenly spaced around perimeter every 15' - 20'
- Includes 50 polypro sand bags (sand not included)

3 Year Limited Warranty

1150094	Baseball Cover 170' x 170', Weight: 1200 lbs	\$9,999 ⁹⁹ EA	
1150100	Baseball Cover 160' x 160', Weight: 1090 lbs	\$9,799 ⁹⁹ EA	
1150117	Softball Cover 120' x 120', Weight: 615 lbs	\$8,999 ⁹⁹ EA	
1236774	Youth League Cover 90' x 90', Weight: 400 lbs	\$4,899 ⁹⁹ EA	

FIELD COVER ACCESSORIES

1. 1150148	9" Anchor Stakes	\$64 ⁹⁹ DZN
2. 1150155	Polypropylene Sand Bags (26" x 14") - 20 per set (Sand not Incl.)	\$249 ⁹⁹ SET OF 20 ★
3. 1150162	Fieldsaver Repair Tape, 3" x 60' Roll	\$84 ⁹⁹ EA



Black	Dark Green	Grey	Brown
Navy	Burgundy	Purple	Tan
Yellow	Red	Royal	White

FIELD TARP STORAGE ROLLER COVER

- Heavy duty 22oz vinyl
- Optional lettering available

K13487	3'T x 3'W x 20'L - used with 90' & 120' Tarps	\$549 ⁹⁹ EA
K14281	3'T x 3'W x 34'L - used with 160' tarps	\$699 ⁹⁹ EA
K35768	3'T x 3'W x 40'L - used with 170' tarps	\$879 ⁹⁹ EA
1298154	Lettering up to 24" Tall	\$129 ⁹⁹ EA



*THE 40' AND 34' TWO-PIECE ROLLER CONNECTS WITH PROVIDED HARDWARE AND REQUIRE CONNECTS HOLES TO BE DRILLED AFTER DELIVERY.

FIELD TARP STORAGE ROLLERS

- Heavy duty corrugated HDPE for tarp storage
- 2-piece rollers provide substantial savings on shipping cost
- Rollers are 28" in diameter

1158939	For 120' and 90' Tarps	\$1,069 ⁹⁹ EA	
1158953	For 160' Tarps	\$2,049 ⁹⁹ EA	
1236781	For 170' Tarps	\$2,099 ⁹⁹ EA	

VARSITY GRADE FIELD COVERS

- Composed of 5 oz woven polyethylene
- Super light, waterproof and mildew resistant
- Heat-sealed seams and double sewn reinforced perimeters
- Brass grommets spaced every 3'
- Ground stakes included with all covers
- Color: Green

1150575	Complete Set (1 x 26'; 1 x 20'; 3 x 10')	\$1,199⁹⁹ SET ★
1150544	26' Circular Home Plate Cover	\$649⁹⁹ EA ★
1150551	20' Circular Pitcher's Mound Cover	\$499⁹⁹ EA ★
1150568	10' Square Base Covers	\$379⁹⁹ SET ★

COLLEGIATE GRADE FIELD COVERS

- Composed of 14 oz vinyl
- Heat-sealed seams and double sewn reinforced perimeters
- Brass grommets spaced every 3'
- Ground stakes included with all covers
- Color: Royal Blue

2 Year Limited Warranty

1238457	Complete Set (1 x 26'; 1 x 20'; 3 x 10')	\$1,649⁹⁹ SET ★
1149685	30' Circular Cover	\$1,149⁹⁹ EA ★
1149692	26' Circular Cover	\$899⁹⁹ EA ★
1149708	20' Circular Cover	\$649⁹⁹ EA ★
1149715	10' Square Base Covers	\$469⁹⁹ SET ★

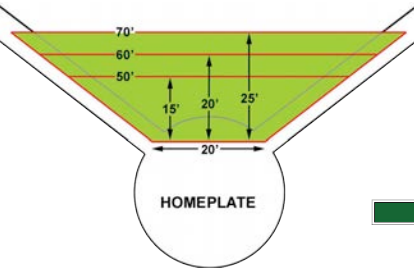

BP ZONE® BASICTURF PROTECTOR

- Constructed of varsity level 9 oz. mesh material
- Perimeter edges are hemmed and grommets

K13351	20'W x 15'D x 50'L	\$619⁹⁹ EA
K13352	20'W x 20'D x 60'L	\$724⁹⁹ EA
K13353	20'W x 25'D x 70'L	\$949⁹⁹ EA

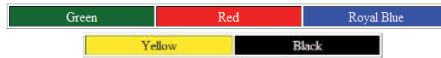

FIELD WEIGHTS (SET OF 4)

- The perfect alternative to sand bags
- Features an easy grip handle
- Durable so they won't tear and leave a sandy mess

1373618	7 lbs each - 28lbs.	\$319⁹⁹ SET
----------------	---------------------	-------------------------------



FIELD WEIGHT & TARP CART

- Designed to transport area tarps and field weights
- Includes 1 set of 36 field weights
- Heavy duty, powder coated steel construction
- 2 large pneumatic turf tires
- Tow bar and wheel barrow handles
- Fits thru a standard door

1373617		\$3,299⁹⁹ EA
----------------	--	--------------------------------

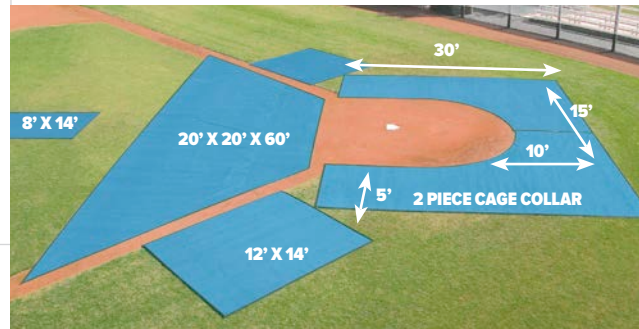

BP ZONE® BATTING PRACTICE TURF PROTECTORS

- Tough 20 mil. VIPOL® Matrix Mesh provides the highest level of spike protection for turf
- Same material as used by top high schools, NCAA, Major League Baseball and NFL teams
- All edges are hemmed and grommets
- Complete set includes 8' x 14' blanket, 2 piece cage collar, two -12' x 14' blankets for fungo areas and a 20'W x 20'D x 60' across trapezoid shaped infield protector
- Available in 20 colors - see color bar below
- Chroma-Bond® imprinting available and sold separately

1159899	Complete Set	\$3,299⁹⁹ SET
1159905	2 Piece Cage Collar Only	\$1,499⁹⁹ PR
1159912EA	Individual 8' x 14' Turf Mat	\$299⁹⁹ EA
1159929EA	Individual 12' x 14' Turf Mat	\$374⁹⁹ EA
1159837	20'W x 20'D x 60' L	\$1,599⁹⁹ EA

WIND WEIGHTED FIELD TARPS

- Famous Rain covers that stay put without stakes or sandbags
- Steel chain in edge hem allows these tarps to stay down even in high winds
- Field proven to 65mph.
- Industrial 18oz. vinyl-polyester fabric with UV and mildew inhibitors
- Major League Style, rounded to fit inside dirt circle for extended use in sun and for optimum dirt moisture management

2 Year Limited Warranty

K35566	12' Diameter	\$749⁹⁹ EA
K35567	18' Diameter	\$1,249⁹⁹ EA
K35568	20' Diameter	\$1,349⁹⁹ EA
K35569	26' Diameter	\$1,699⁹⁹ EA
K35570	30' Diameter	\$2,049⁹⁹ EA
K35571	10' x 10' Square	\$1,499⁹⁹ EA



Batting Cage Turf

- Durable, long-lasting and easy to maintain
- Protects from inclement weather
- Softens ball impact
- Increases life of practice balls

BATTING MATS ARE RECOMMENDED FOR HIGH TRAFFIC AREAS TO MAXIMIZE TURF LIFE

AVAILABLE IN 55' AND 70' ROLLS

PADDED

UNPADDED

BEST

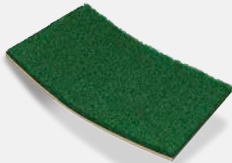

BSN PLATINUM

- Durable, long lasting, nylon turf
- 5mm foam pad

1458164	15'W x 55'L	\$4,579.99 roll
1458166	15'W x 70'L	\$5,899.99 roll
1458168	Custom Length*	\$10.99/sq. ft.

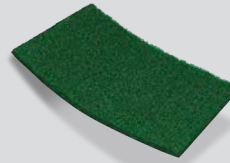

BSN PLATINUM

- Durable, long lasting, nylon turf
- Latex backing

1458163	15'W x 55'L	\$3,099.99 roll
1458165	15'W x 70'L	\$3,929.99 roll
1458167	Custom Length*	\$7.29/sq. ft.

BETTER



BSN GOLD

- Made from polyethylene yarn
- Plush and soft to the touch
- 5mm foam pad

1458158	15'W x 55'L	\$3,399.99 roll
1458160	15'W x 70'L	\$4,299.99 roll
1458162	Custom Length*	\$8.49/sq. ft.

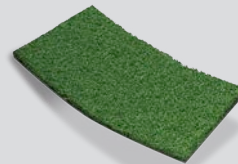

BSN GOLD

- Made from polyethylene yarn
- Plush and soft to the touch
- Latex backing

1458157	15'W x 55'L	\$1,929.99 roll
1458159	15'W x 70'L	\$2,479.99 roll
1458161	Custom Length*	\$5.29/sq. ft.

GOOD

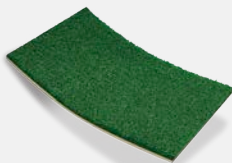

BSN SILVER

- Great value, can withstand the rigors of everyday cage use
- Polypropylene yarn
- 5mm foam pad

1458152	15'W x 55'L	\$2,999.99 roll
1458154	15'W x 70'L	\$3,799.99 roll
1458156	Custom Length*	\$9.29/sq. ft.

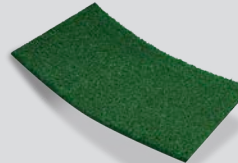

BSN SILVER

- Great value, can withstand the rigors of everyday cage use
- Polypropylene yarn
- Latex backing

1458151	15'W x 55'L	\$1,499.99 roll
1458153	15'W x 70'L	\$1,899.99 roll
1458155	Custom Length*	\$3.69/sq. ft.

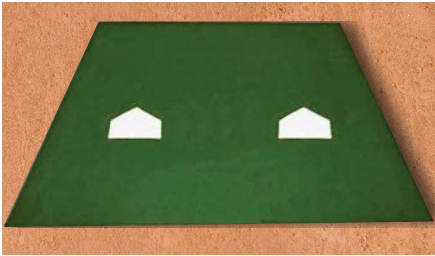

DIAMONDTURF BULLPEN MAT

- Comes with 2 side-by-side home plates
- Standard turf green only

1235944 12' x 12' - Weight: 135 lbs **\$1,499⁹⁹** EA

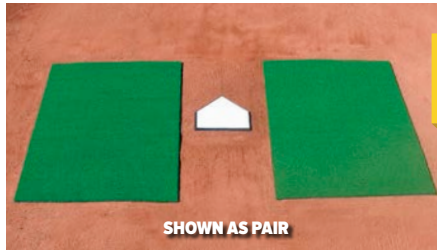

SHOWN AS PAIR

DIAMONDTURF BATTER'S MATS

- Standard turf green only

1235951 Baseball - 4' x 6' - Weight: 22 lbs. **\$479⁹⁹** EA
1235968 Softball - 3' x 7' - Weight: 20 lbs. **\$379⁹⁹** EA



DIAMONDTURF PITCHER'S MATS

- Standard turf green only

1235920 4' x 12' - Weight: 30 lbs **\$649⁹⁹** EA
1235937 6' x 12' - Weight: 58 lbs **\$699⁹⁹** EA



DIAMONDTURF 6' ON-DECK CIRCLE

- Weight: 40 lbs per pair

1235975 Green **\$999⁹⁹** PR
K13823 Please Specify Color **\$999⁹⁹** PR



COACH'S CHOICE

HOME PLATE MATS!



HOME PLATE MATS

- For indoor/outdoor cages and on-the-field BP
- Will hold up to moderate spike-cleat traffic.
- Features a thick foam backing with inlaid white turf lines
- Comes with a heavy-duty throwdown home plate

1235890 Baseball (Clay) - 6' x 12' **\$699⁹⁹** EA
1235906 Baseball (Green) - 6' x 12' **\$699⁹⁹** EA
1235913 Softball (Green) - 7' x 12' **\$719⁹⁹** EA

BP MAT WITH CATCHERS EXTENSION

- Attached with a six-foot-long sewn-on Velcro strip
- Velcro on both sides of the extension so the mat can be rotated for maximum use and minimum wear
- Heavy duty design will hold against a batter's twisting
- Easily rolled up and stored

1373619 Green **\$749⁹⁹** EA
1373620 Clay **\$749⁹⁹** EA



DIAMONDTURF HALO MATS

- Made from spike proof DiamondTurf
- Eliminates turf replacement and the need for constant maintenance around home plate
- Kits come pre-cut to fit a 13' radius from the rear point of home plate
- Requires a concrete or asphalt base under turf
- Comes with either a unitary (carpet without padding) backing or with a 5mm foam pad backing
- Green turf only

K13171	5' Halo Kit without wings (unitary backing)	\$8,299⁹⁹ EA	
B5HK5P	5' Halo kit with wings (unitary backing)	\$8,999⁹⁹ EA	
K13173	10' Halo Kit without wings (unitary backing)	\$9,299⁹⁹ EA	
B5HK10P	10' Halo Kit with wings (unitary backing)	\$9,999⁹⁹ EA	
K13175	5' Halo Kit without wings (foam pad backing)	\$8,999⁹⁹ EA	
K13857	5' Halo Kit with wings (foam pad backing)	\$7,899⁹⁹ EA	
K13177	10' Halo Kit without wings (foam pad backing)	\$11,499⁹⁹ EA	
K13865	10' Halo Kit with wings (foam pad backing)	\$10,899⁹⁹ EA	
K13871	1 Color Letter in 5' halo	\$399⁹⁹ EA	
K13872	2 Color Letter in 5' halo	\$799⁹⁹ EA	
K13881	1 Color Letter in 10' halo	\$549⁹⁹ EA	
K13882	2 Color Letter in 10' halo	\$999⁹⁹ EA	



2-COLOR LETTERING ON 10' HALO KIT WITH WINGS



DIAMOND PRO

PROFESSIONAL GROUNDSKEEPING PRODUCTS

SOLD BY THE PALLET

CALL FOR FREIGHT QUOTE

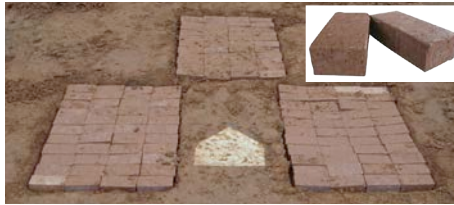

MOUND/HOMEPLATE CLAY BRICKS

- Mound/ Home plate clay bricks are unfired compressed clay bricks perfect for building or repairing high stress areas
- The bricks, when watered, simply turn to firm clay to provide durability and reduced maintenance in these areas
- Brick size: 4" x 8" x 2-1/2"
- 300 bricks per pallet

DPROB12TX \$1,049.99 PALLET S&H



MOUND/HOMEPLATE CLAY

- Mound/ Home plate clay is a screened clay loam with a rich red color, which easily conforms and binds to the existing surface
- The loose clay easily tamps into holes providing greater durability and less maintenance
- 50 lb. bags/40 bags per pallet

DPROCLTX \$769.99 PALLET S&H



ATHLETIC FIELD MARKING DUST

- Bright premium marking dust complies with the NCAA rules
- Non-toxic, non-burning and harmless to soil and turf
- 50 lb. bags/40 bags per pallet

DPROMDTX \$999.99 PALLET S&H



CALCINED CLAY TOP DRESSING

- A calcined clay product used on the skinned areas of baseball and softball fields to improve drainage
- The larger product size increases the durability of the product
- It will not stick to cleats and is easily incorporated into the infield
- 50 lb. bags/40 bags per pallet

DPROCCDTX \$999.99 PALLET S&H



CALCINED CLAY DRYING AGENT

- A calcined clay product used to quickly dry puddles and muddy conditions
- The finer gradation has more surface areas to dry the field faster, reducing rain delays
- It will not stick to cleats and is easily incorporated into the infield
- 50 lb. bags/40 bags per pallet

DPROCCDATX \$949.99 PALLET S&H



RED INFIELD CONDITIONER

- A vitrified clay (expanded shale and clay) product applied to skinned areas of baseball and softball fields
- Red infield conditioner helps create a natural look that enhances the appearance of an infield
- 50 lb. bags/40 bags per pallet
- Bulk delivery is available upon request

DPROICTX \$949.99 PALLET S&H

TURFACE ATHLETICS

SOLD BY THE PALLET // CALL FOR FREIGHT QUOTE

TURFACE MVP

- Maintain a smooth, cushioned playable surface
- Excellent for incorporating into infield mix, topdressing to create a consistent and level playing surface.
- Fight infield compaction that leads to running, sliding and bad hop injuries
- Ideal for new infield construction or renovation
- 50lb bags/ 40 bags per pallet

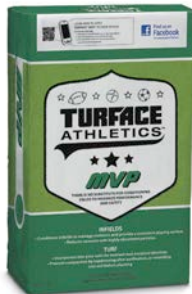

1459334 \$799.99 PALLET S&H

5 STAR PACKING CLAY

- Clay-silt mixture bonds quickly and packs tightly to help streamline installation
- Highly durable, long lasting performance and wear resistance
- Suitable for all levels of play
- Premium mound and plate clay that holds up to all of play
- 50lb bags/ 40 bags per pallet



1459335 \$769.99 PALLET S&H

QUICK DRY

- Absorbs its weight in water
- Will not harden or cake like similar water absorbing products
- Used for quickly drying up puddles and mud on skinned infields
- Rake in to make the field safe and playable
- 50lb bags/ 40 bags per pallet

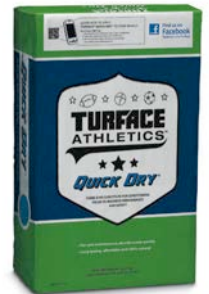

1459336 \$629.99 PALLET S&H

PRO LEAGUE ELITE-HERITAGE RED

- Creates superior sliding and fielding surfaces
- Remains consistent color in wet or dry conditions
- Ideal top dressing material for skinned infields
- 50lb bags/ 40 bags per pallet



1459337 \$849.99 PALLET S&H

PRO LEAGUE ELITE-NATURAL

- Designed for ultimate fielding and sliding surfaces
- Outstanding drainage and absorption qualities for maximum rain out protection
- Designed for increase safety and playability for all levels
- 50lb bags/ 40 bags per pallet



1459338 \$729.99 PALLET S&H

MOUNDMASTER BLOCKS

- 100% pure virgin clay blocks deliver long lasting performance
- Blocks are sized perfectly for building boxes and the mound from the ground up
- Packaged in 8 block sets in air tight bags to retain proper moisture
- Blocks are 2 1/4" x 4" x 8"
- 500 bricks per pallet



1459339 \$999.99 PALLET S&H

4-WHEEL LINE MARKERS W/ PNEUMATIC TIRES

- The most durable line marker on the market
- 11 gauge steel frame
- 18 gauge galvanized steel bucket
- Tires measure 3.5"W x 10"D
- Easily adjustable to either 2" or 4" lines

18 Month Limited Warranty

1. BBHDDM10	100 lb. Capacity	\$699⁹⁹ EA ★
2. BBHDDM50	50 lb. Capacity	\$679⁹⁹ EA ★

4-WHEEL DRY LINE MARKER

- All steel construction
- 4 hard rubber wheels for extra durability
- Easily adjustable to either 2" or 4" lines

3. BBDLM654	4-Wheel 65 lb. Capacity	\$529⁹⁹ EA ★
--------------------	-------------------------	--------------------------------

2-WHEEL DRY LINE MARKER

- All steel construction
- 2 hard rubber wheels for extra durability
- Easily adjustable to either 2" or 4" lines

4. BBDLM252	2-Wheel 25lb. Capacity	\$349⁹⁹ EA ★
--------------------	------------------------	--------------------------------



STREAMLINER 354 DRY LINE MARKER

- Heavy duty steel design
- Flexible brush agitator to improve chalk flow
- Smoother tracking for straighter, more consistent lines
- One button retractable handle for easy storage

1459373	35lb Capacity	\$879⁹⁹ EA
----------------	---------------	------------------------------



DURASTRIPE MARKING PAINT

- 20oz cans with 18oz by volume
 - Non-clogging, cans will empty completely
 - Safe for user, environment and all varieties of grass
 - Extremely durable, will not wash away with rain and elements
 - Aerosol cans come standard with a custom "T" spray for a crisp, wide athletic field lines
- Color Options: **Colt Gray, Handicap Blue, Brown Line, Syracuse Orange, North Carolina Blue, Vanderbilt Gold, Turf Green, Aluminum, Black, Brown, Burgundy, Burnt Orange, Cardinal, Clear, Columbia Blue, Augusta Green, Old Gold, GRAY, Green, Maroon, Navy, Orange, Pink, Purple, Red, Royal, Tan, Teal, Team Orange, Vegas Gold, White, Yellow.**

1460342 Case of 12 Cans-Specify Color \$109⁹⁹ CASE ★

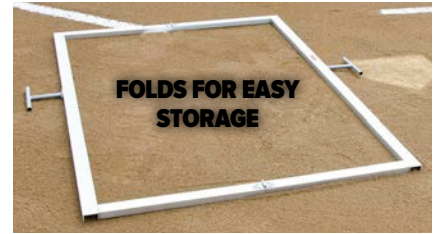

FOLDABLE BATTER'S BOX TEMPLATES

- Lightweight aluminum frame template
- Simply line the handle up with the straight side edge of the plate and you will be square and the correct distance away from for proper alignment
- Step on template and leave a 2" W impression to chalk over
- Folds in half for easy transport

BBTMPL46	4' x 6' Baseball	\$549 ⁹⁹ EA ★	
BBTMPL37	3' x 7' Softball	\$549 ⁹⁹ EA ★	
BBTMPL36	3' x 6' Little League	\$529 ⁹⁹ EA ★	

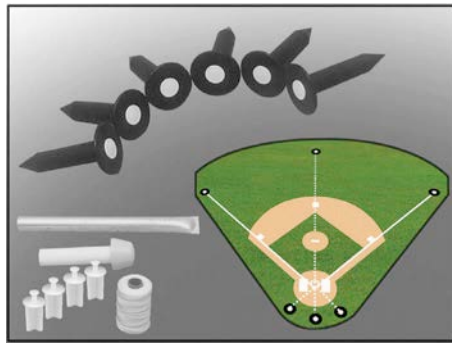

BASEBALL FIELD LINING KIT

- The essential kit to properly line all baseball or softball fields
- Provides 6 ground sockets to establish perimeter and midfield locations and hold game day markers
- Kit includes: 6 sockets with plugs, 4 lining pegs, pilot hole tube and socket setter

MKBLP6 \$149⁹⁹ EA

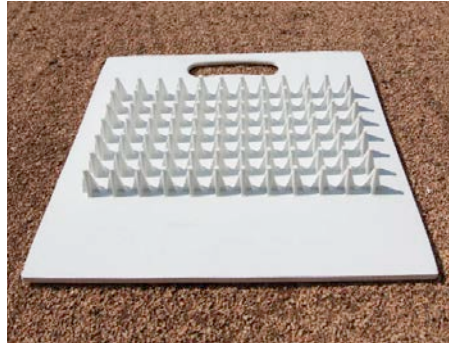

CLEAT AND SPIKE CLEANER

- Durable molded PVC construction
- UV protected to withstand outdoor conditions
- Extended side panel
- Built in handle for easy transport

1186796 19" x 14" \$119⁹⁹ EA ★



STRIPING MACHINE WITH 10' WHEELS

This striping machine is perfect for everyday field striping. It's 10" diameter wheels make for a smooth roll and less effort.

1460691 \$299⁹⁹ EA ★



STRING WINDER - PRO CORD

- Braided thick cotton string line
- High impact plastic reel

1459374 500' Cord \$149⁹⁹ EA

COACH'S CHOICE



TAMP

- Tamp base is made of 1/2"-thick steel plate
- Covers a 12" x 12" area
- Heavy duty 48" steel handle

BBTAMPBM

\$189⁹⁹ EA ★

TAMP COVER

- Designed to make tamping wet clay a simple, hassle free process as the cover does not allow wet dirt to stick to the tamp plate.
- Fits 12" x 12" tamp.

1088137DS

\$89⁹⁹ EA



THREE-ROW MONSTER BROOM

- 7' broom is excellent for dressing softball or baseball infields
- May also be used for sweeping warehouse floors, tennis courts and pavement
- Made with heavy-duty aluminum construction

BBDRGBRM

\$369⁹⁹ EA



BEACON ATHLETICS SWEET SPOT TAMP

- 4 interchangeable heads for accurate coverage
- Extra 5.5" handle to help reduce/eliminate vibration
- Great for groundskeepers and landscapers

1459375	Tamp Handle Only	\$119⁹⁹ EA
1459376	4" x 6" Head Only	\$79⁹⁹ EA
1459377	6" x 6" Head Only	\$89⁹⁹ EA
1459378	8" x 8" Head Only	\$99⁹⁹ EA
1459379	10" x 10" Head Only	\$109⁹⁹ EA



INFIELD LIP BROOM

- Heavy duty 28" broom head with two rows of replaceable bristles and 5' powder-coated aluminum handle, bent to reduce back strain
- Ideal for brushing top-mix out of turf
- Use back side to scrape and break-up hard dirt

1148497

Size - 28"W

\$229⁹⁹ EA



SUPER SOPPER

- Pick up water & carry it away from playing surface
- For grass, tennis courts or artificial turf

BBSSMCKR
BBSSDLPH

7 gallon holding tank
14 gallon holding tank

\$1,229⁹⁹ EA
\$1,549⁹⁹ EA



BEACON ATHLETICS

COCOA INFIELD FINISHING MOPS

- Designed for those small areas-impossible to finish grooming
- Great for pitching mounds, batters boxes, base paths and on-deck circles
- Heavy-duty reinforced aluminum.

1091526

2'W x 18"D

\$279⁹⁹ EA



BEACON ATHLETICS

PUDDLE SPONGE

- Sponge is built to last through several seasons of use.
- Absorb puddles, squeeze out the puddle water in a grassy off-field area and then hang to dry.

1459387

Set of 3

\$139⁹⁹ EA

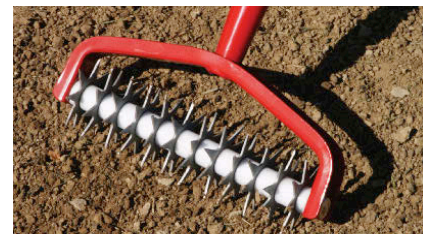

OVERSEED ENHANCING TOOL

- 12 self-sharpening steel star wheels penetrate any compacted soil
- Perfect for overseeding wear areas on your field
- Creates excellent seed-to-soil contact, critical for successful germination
- 9"W head w/60" steel handle.

1149012

\$209⁹⁹ EA ★

HOSES



DOUBLE PLAY INFIELD RAKE

- Short teeth break up the hard clay
- Longer teeth sift the top soil for general grooming

1234985	Size - 24"W	\$189 ⁹⁹ EA ★
1234992	Size - 36"W	\$199 ⁹⁹ EA ★



LEVELING BOARD

- 54" width
- Ideal for levelings infield, bases, home plate & pitchers mound
- Leaves smooth finish on wet or dry field
- Heavy duty aluminum handle
- Steel cutting edge for filling high & low spots.

1149005		\$279 ⁹⁹ EA ★
----------------	--	--------------------------

COACH'S CHOICE

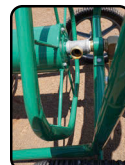

ENDURO HOSE REEL SYSTEM

- Heavy duty, powder coated steel construction
- Large 14" solid rubber wheels for smooth transport
- Includes a 1" x 6'L supply line hose
- Accommodates 150' of 1" hose
- Complete kit includes: Enduro Hose Reel, 1" x 100' Quick Wet Down Water Hose (1275179) and the 1" Aluminum Spray Nozzle (1237108)

MSHREEL2	Hose Reel Only	\$599 ⁹⁹ EA ★
K35559	Complete Kit	\$669 ⁹⁹ EA



PRO 1" SPRAY NOZZLE

- Aluminum design
- Adjustable from mist to stream
- Up to 35 GPM (gallons per minute)

1237108	Aluminum Spray Nozzle-Fits 1" hose	\$229 ⁹⁹ EA
----------------	------------------------------------	------------------------

JOX BOX

(PHOTOS SHOW JOX BOX PRIOR TO INSTALLATION)

Eliminates holes in batter's boxes, in pitcher's area, and in front of bases. After proper installation, the Jox Box is low maintenance. Durable design resists steel cleats and is waterproof. Your field material is brushed into surface after installation to create a smooth transition. All are shipped motor freight.



BATTERS BOX FOUNDATION

- Recycled rubber mats
- Eliminates deep holes in box areas
- Bury under 3" - 4" of dirt or clay
- Sold in pairs

MK3240	Size - 32"L x 40"W x 3/4"D	\$529 ⁹⁹ PR
---------------	----------------------------	------------------------



BATTERS BOX

- Eliminates holes in batters boxes, in pitcher's area, and in front of bases
- After proper installation, the Jox Box is low maintenance
- Durable design resists steel cleats and is waterproof
- Size is 4' x 8' overall, 3' x 7' exposed after installation

1235814	Set of 2	\$2,199 ⁹⁹ PR
----------------	----------	--------------------------

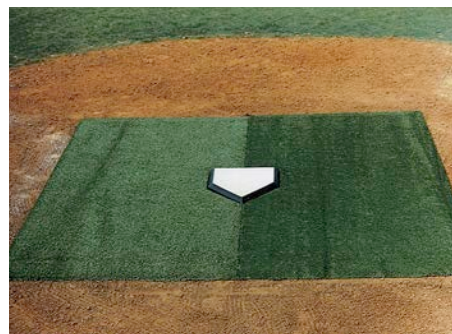

DELUXE BATTERS BOX

- Covers the entire homeplate area with a cut-out for homeplate
- Made in 2 pieces that butt together when installed

1235838	Youth Size 7' x 9' - Weight: 550 lbs	\$2,499 ⁹⁹ EA	
1235821	Full Size 8' x 10' - Weight: 550 lbs	\$2,699 ⁹⁹ EA	



MOUND SLOPE GAUGE

- This popular mound building tool is the most accurate way to ensure proper height and taper
- Includes bubble level, metal ruler, 2 support rods and complete instructions for mound construction and maintenance

1148992

\$649⁹⁹ EA



PRO SHOT HOSE NOZZLE

- Flush setting to clear small particles from becoming lodged
- Easily adjusts from fine to blast spray

1459380

Fits 1" hose

\$669⁹⁹ EA



GH FIELD HOSE

- Designed to increase working pressure up to 150psi
- Smooth PVC inner tube
- Ozone and ultraviolet resistant

1459381	50'	\$249 ⁹⁹ EA
1459382	100'	\$499 ⁹⁹ EA



ULTRALITE FIELD HOSE

- Fits 1" nozzle
- Abrasion resistant poly cover
- Working pressure is 300psi

1459383	50'	\$349 ⁹⁹ EA
1459384	100'	\$549 ⁹⁹ EA



PRO FLEX HOSE

- Fits 1" nozzle
- Long shank machine brass fitting
- Working pressure up to 150psi

1459385	50'	\$329 ⁹⁹ EA
1459386	100'	\$499 ⁹⁹ EA

GRATE GUARDS

- Cover your hazardous drainage grates and utility boxes with non-skid, recycled rubber covers
- Water flows through; approximately 3/4" thick
- Color: Dark Green only

1170467 Square Grate Guard - 37" x 37" \$329⁹⁹ EA



COACH'S CHOICE



ALUMINUM MAINTENANCE RAKE

- All aluminum construction
- Durable and lightweight with oversized teeth for easy field grooming & pit maintenance
- Use one side to rake and the other side to level
- 58" long handle

1196238	Size - 24"W	\$119 ⁹⁹ EA ★
1196245	Size - 36"W	\$129 ⁹⁹ EA ★
1196252	Size - 48"W	\$139 ⁹⁹ EA ★

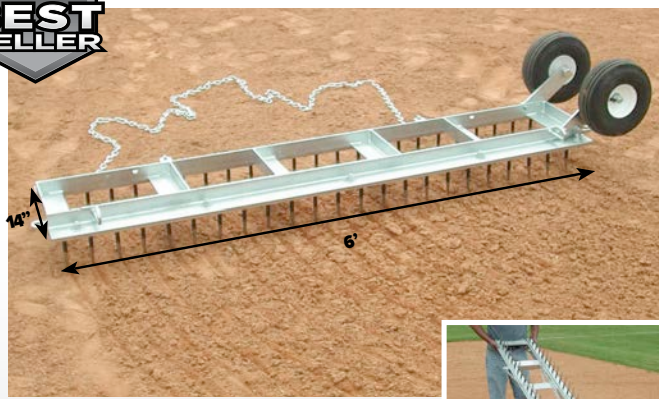

DIAMOND DIGGER FIELD GROOMER

- Hot dipped galvanized steel frame
- Uses 4.5" sharpened and hardened steel cutting teeth
- No-flat wheels allow you to roll for transport
- Pull chain is provided
- Hooks on rear allows for attachment of drag mat
- Remove wheels to turn groomer over and use as a leveling sled
- Recommended to be pulled by a tractor



BSDDRAG	Diamond Digger w/Wheels, Wt 100 lbs.	\$979 ⁹⁹ EA ★
BSDDWHL	Set of 2 Wheels	\$299 ⁹⁹ EA ★
ZBDNAIL	Repl. Teeth for Diamond Digger	\$189 ⁹⁹ PACK ★

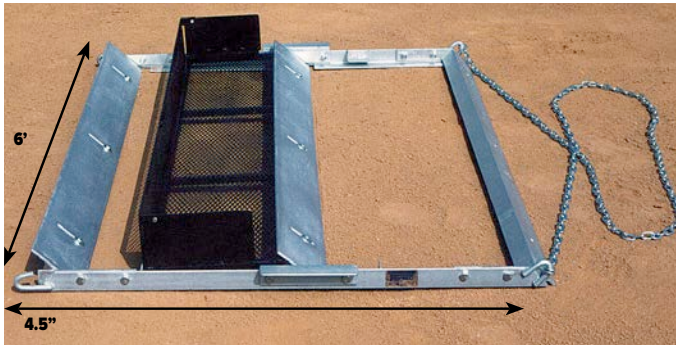

CUT N' LEVEL DRAG

- The Cut-N-Level drag is designed for grooming the surface of playing fields
- Features flat steel cutting blades and a screen for rock removal
- Made from 16 gauge metal, the cutting blades are slotted and attached to the main frame with bolts, allowing the operator to adjust the blades for the desired depth of cut
- Used in routine maintenance, the Cut-N-Level drag can be used for rock removal, smoothing and leveling the field as the need arises, saving hundreds of man-hours normally needed to do these jobs
- Frame and blades are galvanized
- Weight: 220 lbs.

BSCLDRAG	Size - 6'W x 4'6"L	\$1,599 ⁹⁹ EA ★
-----------------	--------------------	----------------------------



BUY THE COMBO AND SAVE!

DIAMOND DIGGER FIELD GROOMER - COMBO

- Purchase the Diamond Digger together with our Heavy Duty drag mat (1149821) and save

BSDDRAG	Complete Combo	\$1,199 ⁹⁹ EA ★
----------------	----------------	----------------------------

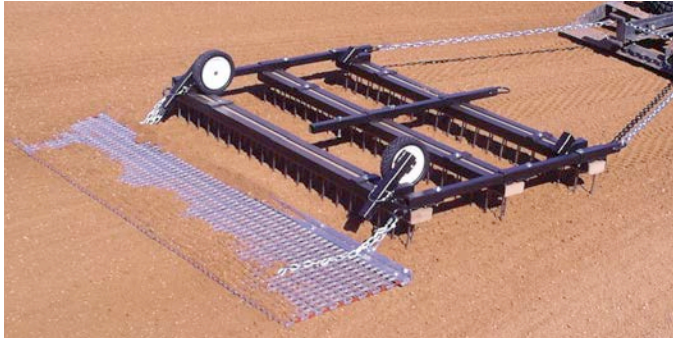

5' X 3' PREMIUM NAIL DRAG

- Welded steel frame supports 117 - 6"L x ¼"D grooming nails
- Wheels and tongue make moving and storing these units easy
- Comes complete with 6'W x 18"L rigid drag mat
- All attachments, hardware and pull chains are included
- Frame size 5' x 3'. Weight: 120 lbs.

BS53DRAG	Nail Drag w/ Rigid Drag Mat (shown)	\$1,499 ⁹⁹ EA ★
BS53DRAG	Nail Drag w/ Drag Chain only	\$1,199 ⁹⁹ EA ★
BSNAILPK	Replacement Nails (pack of 117)	\$134 ⁹⁹ EA

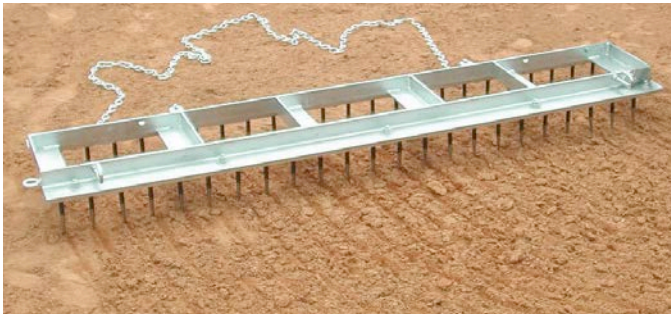

BIG LEAGUE FIELD DRAG

- Designed to break up dirt or cinders on the baseball field or track
- Features forty-six 4.5" steel cutting teeth
- Frame is hot dipped galvanized steel
- Heavy duty pull chain included
- Recommended to be pulled by a tractor
- Grooming drag chain included
- Flip over and use as leveling drag
- Weight : 88 lbs.

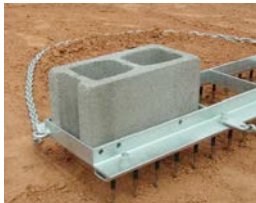

BSDRAG	Size - 14"W x 6'L	\$729 ⁹⁹ EA ★
---------------	-------------------	--------------------------



NEW STRIPE

DIRT MEDIC WITH BRUSH

- Break-up packed surface and level ridges and ruts
- Can be towed with garden tractors, ATV's or light utility vehicles
- Weighs less than 200lbs.
- Teeth may be completely raised to use just the blade and/or broom

1378377	32"W x 62"L x 36"H	\$3,299 ⁹⁹ EA
----------------	--------------------	--------------------------

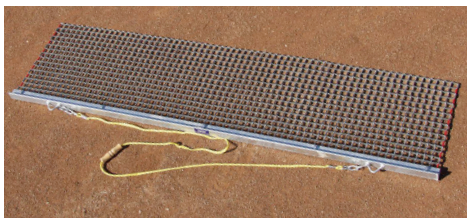

RIGID DRAG MATS

- Rugged all-steel drag mats have 1" x 1" mesh with 13 gauge galvanized connecting rods
- Mesh material is 3/8" x .050 galvanized steel
- Cannot be rolled up for storage
- Includes heavy-duty angle iron across front of mat and a rope with handle for pulling

DMATR6X3	6'W x 3'L, Wt 44 lbs.	\$549⁹⁹ EA ★
DMATR6X18	6'W x 18"L Weight: 35 lbs.	\$399⁹⁹ EA ★
DMATR4X3	4'W x 3'L, Weight: 36 lbs.	\$429⁹⁹ EA ★
DMATR4X18	4'W x 18"L Weight: 24 lbs.	\$369⁹⁹ EA ★



COCOA DRAG MATS

- Constructed from natural cocoa fibers that "float" across the surface producing a beautiful finish with minimal buildup of your infield mix
- Solid-steel twin blade cutting edge to level rough spots
- Great on turf to break up core aeration plugs and smooth in top-dressing materials
- Handle grip for easy transport

1091540	Standard Cocoa Drag - 4' x 2'	\$549⁹⁹ EA
1091557	Large Cocoa Drag - 6' x 2'	\$629⁹⁹ EA
1091564	Jumbo Cocoa Drag - 6' x 4'	\$749⁰⁰ EA

6' CUTTING BAR (WITH DRAG)

- Unique 6' asymmetrical cutting bar levels & smooths rough spots and eliminates ridge build-ups
- The cutting bar is sized to match our 6' x 6' drag mats
- Includes quick-link attachments
- Combo unit includes cutting bar and 6' x 6' drag (DMAT6X6)



1237009	Cutting Bar only	\$369⁹⁹ EA
1273410	Cutting Bar w/drag combo	\$829⁹⁹ EA ★



HAND NAIL DRAG

- Ideal for scarifying baselines, cutouts and home plate areas, as well as daily nail dragging of infield skin
- Constructed of plastic lumber and hardened 1/4" steel spikes and can be pulled in either the 3'W or 2'W direction by simply changing the tow rope connection point
- Pull rope included

1236996	Size - 3' x 2'	\$749⁹⁹ EA
----------------	----------------	------------------------------

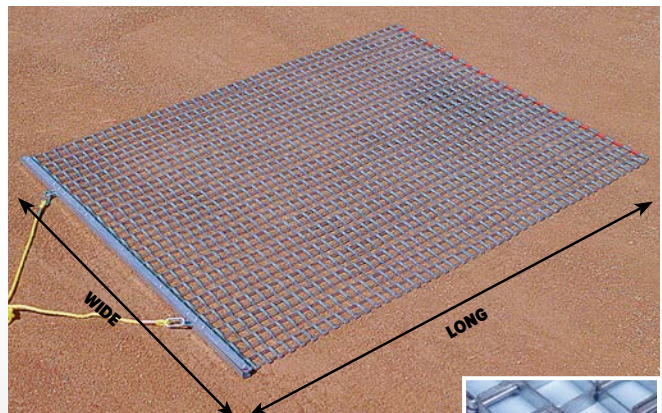

ALL-STEEL DRAG MATS

- Workhorse, all-steel drag mat comes complete with drag bar and pull rope
- Mesh material is 3/8" x .050 galvanized steel
- Perfect for general grooming and maintenance



BBMAT35X	Size - 3'W x 5'L - Weight: 28lbs.	\$319⁹⁹ EA ★
1200423	Size - 3'W x 4'L - Weight: 23lbs.	\$299⁹⁹ EA ★
1200430	Size - 6'W x 3'L - Weight: 38lbs.	\$399⁹⁹ EA ★
BBMAT66X	Size - 6'W x 6'L - Weight: 64lbs.	\$599⁹⁹ EA ★
BBMAT106	Size - 10'W x 6'L - Weight: 97 lbs.	\$799⁹⁹ EA ★ 

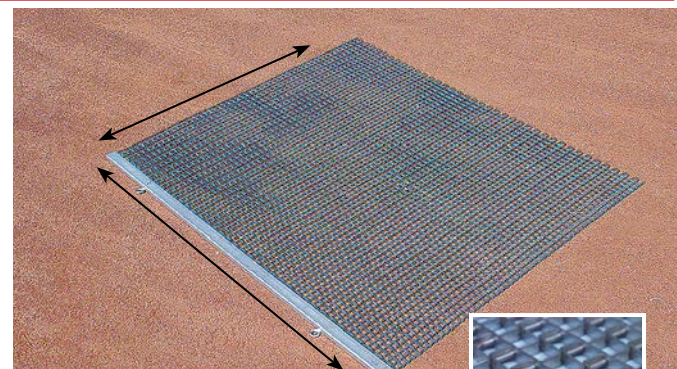

MONSTER DRAG MAT

- Deluxe mat construction utilizes 1/2" x .062 mesh with 6 gauge connecting rods, each welded on end
- Includes angle iron front with welded eye bolts to attach your chain

1159608	Size - 6'W x 4'L	\$749⁹⁹ EA ★
----------------	------------------	--------------------------------

COACH'S CHOICE

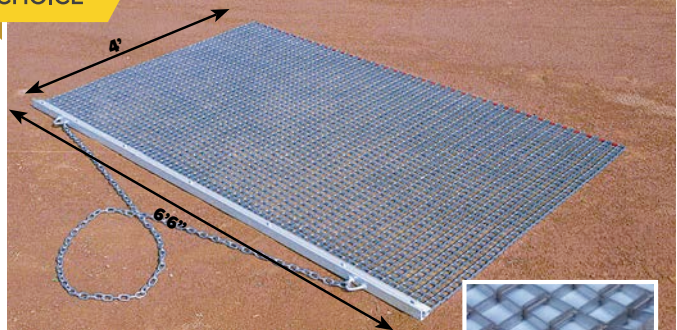

HEAVY DUTY DRAG MAT

- Mesh is 3/8" x .050 galvanized steel
- Includes heavy duty angle iron across front of mat and a heavy duty chain for tractor pulling
- Weight: 68 lbs.



1149821	Size - 6'6"W x 4'L	\$649⁹⁹ EA ★
----------------	--------------------	--------------------------------

PITCHERS PLATES

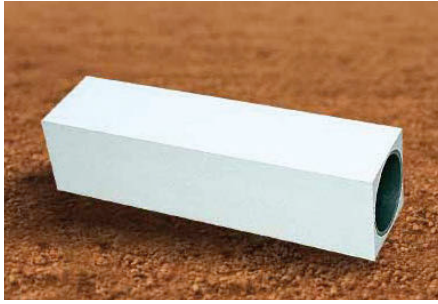

4-WAY PITCHER'S RUBBER

- Comes complete with inner support tubing
- Designed to be rotated periodically for extended life

BBPR4WAY	Official Size - 6" x 24"	\$199.99 EA ★
BBPR4YTH	Youth Size - 4" x 18"	\$179.99 EA ★



REMOVABLE PITCHER'S PLATE & ANCHOR

- Semi-permanent anchoring system
- Powder coated steel stanchion bolted to the pitcher's rubber

BSIGPPSR	Complete Set - Official Size 6" x 24"	\$109.99 EA ★
1033434	Official Ground Anchor w/ Insert	\$59.99 EA ★
1033465C	Complete Set - Youth Size 4" x 18"	\$79.99 SET ★
1033441	Youth Ground Anchor w/ Insert	\$59.99 EA ★



PROFESSIONAL REMOVABLE PITCHING RUBBER

- All steel ground anchor to be cemented into ground
- Pitcher's rubber is bolted and silicone-sealed to the top stanchion
- Comes with two rubber anchor plugs and an anchor digout tool

BSPIGP	Official Size - 6" x 24"	\$339.99 SET ★
---------------	--------------------------	-----------------------



PITCHER'S RUBBER

- Solid white molded rubber
- Includes three metal spikes

BBPLATE	Official Size - 6" x 24"	\$74.99 EA ★
BBPPLLXXY	Youth Size - 4" x 18"	\$49.99 EA ★



END SPIKED PITCHING RUBBERS

- Spikes go through steel tabs for easy installation
- Includes 4 spikes

1147902	Official Size - 6" x 24"	\$69.99 EA ★
1148466	Youth Size - 4" x 18"	\$49.99 EA ★
1148473	Extra Hammer Spikes	\$24.99 PACK OF 4 ★



STEP DOWN PITCHER'S RUBBER

- Wooden core with solid molded cover and front extension to prevent holes in the front of the plate and reduce maintenance
- No stakes or spikes required

BBPRPROX	Official Size - 6" x 24"	\$164.99 EA ★
BBPRPROY	Youth Size - 4" x 18"	\$129.99 EA ★

HOME PLATES

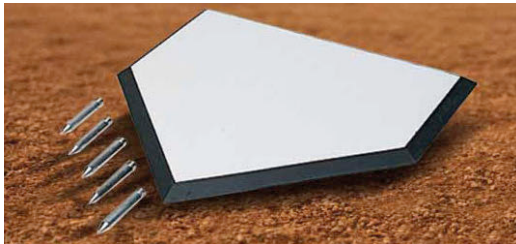

RUBBER HOME PLATE

- Solid white rubber with black beveled edges for safety
- Includes 5 spikes

BBHPXXXXY		\$84.99 EA ★
BBHPSPIK	Replacement Spikes	\$21.99 SET OF 5 ★

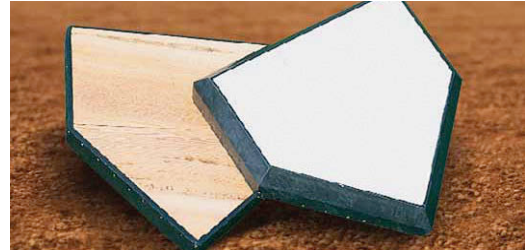

WOOD-FILLED HOME PLATE

- Full traditional solid wood filling for superior durability
- Beveled edges and sides reduce chance of cleats catching

BBHPSAFE	\$189.99 EA ★
-----------------	----------------------



WAFFLE STYLE IN-GROUND HOME PLATE

- All rubber construction
- Waterproof with non-skid surface.

BBHPSAFW	\$159.99 EA ★
-----------------	----------------------

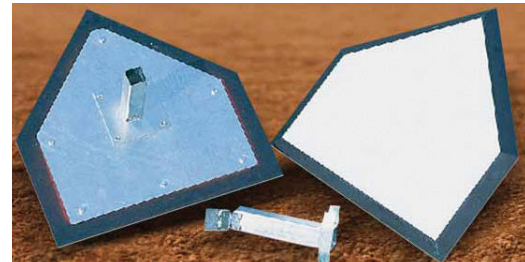

MAJOR LEAGUE HOME PLATE

- Beveled hard white rubber plate
- Includes anchor

BBHPHWDBM	\$199.99 EA ★
------------------	----------------------

PRO BASES



"BOLCO" STYLE STRAPLESS BASES

- Made from rugged, bonded polyester padding that is tear-resistant and waterproof
- The base is easily bolted to its anchor plate
- Anchor plate contains metal sleeve for stability
- Base size - 15"L x 15"W x 3"H

BBBASEOP	Set - 3 Bases, 3 Stakes & 3 Plugs	\$389⁹⁹ SET ★
BBBASEBO	Set - 3 Bases & 3 Stakes	\$329⁹⁹ SET ★
BBBOSPIK	Base Ground Stakes	\$19⁹⁹ SET ★

REC BASES



HEAVY DUTY VINYL BASES

- Inverted sewn seams for extra durability and double-thick-top for long lasting wear
- Outer cover is 100% nylon-impregnated vinyl
- Polyfoam inner core for maximum shape retention
- Packed 3 bases per set with 6 spikes

MCBASE55Y	Official Size - 15" x 15"	\$149⁹⁹ SET ★
MCBASE35Y	Youth Size - 14" x 14"	\$129⁹⁹ SET ★
BBSPIKES	Replacement Spikes	\$42⁹⁹ SET OF 6 ★



MacGregor



MAJOR LEAGUE BASES

- Heavy gauge white rubber cover over a high density foam interior and all welded steel stanchion pan - no bolts to come loose.
- This base is designed to reduce sliding injuries, it is not a substitute for proper sliding
- Base size - 15" x 15" x 3"

BBBASEPR	Set of 3 w/Ground Anchors	\$359⁹⁹ SET ★
BBBASEPX	Set (3)- w/o Ground Anchors	\$349⁹⁹ SET ★
BBBASEPP	Set (3)- w/Ground Anchors, Plugs	\$419⁹⁹ SET ★
1170757	Single Base Only	\$114⁹⁹ EA ★

SAFETY BASES



NOTE: even bases designed to reduce sliding injuries are not a substitute for using proper sliding techniques.

MAGNETIC SUPER BASE

LITTLE LEAGUE® APPROVED.

Reduce the risk of serious injury to sliding players with this unique base designed for all ages. According to Rule 1.06 of the Little League® rule book, Beginning in 2008, it has become mandatory that all leagues utilize bases that disengage their anchor.

Features:

- Bases release when the magnetic attraction between the base and magnetic fixture are overcome by excessive force from a short slide.
- 3 different plate sizes bolt to the bottom of the base pan to adjust the holding strength of the base to the anchor.
- Base cover has a ribbed surface design to reduce the risk of slipping.

BBMMSBXX	Complete Base - 15" x 15" x 3"	\$369⁹⁹ EA ★
Z7BBMAGFIX	Magnetic Base Fixture	\$299⁹⁹ EA ★
1185829	Replacement Base Cover and Pan	\$159⁹⁹ EA ★
BBANCHOR	Ground Anchors - 3/Set	\$79⁹⁹ SET OF 3 ★



MAGNETIC DOUBLE 1ST BASE

- Perfect addition for those who have magnetic type bases
- "White part" is attached to the magnetic stanchion conventionally leaving the safety orange base in foul territory
- "Orange part" is at ground level.

1274127 **\$399⁹⁹** EA ★



SHOCK ABSORBING BASES

- This cushioned base is uniquely designed to help reduce injury
- The base gives at the right time to absorb the brunt of the slide
- Durable, one-piece molded rubber base with no metal parts - No rust!
- Removable white center post for easy storage and replacement.
- Does not include anchors

BBBASRIC	Complete Set without Anchors	\$359⁹⁹ SET ★
BBDFBSTN	Replacement white center posts	\$29⁹⁹ SET OF 3 ★

COACH'S CHOICE



GAME BASE CART

- Heavy-duty construction with 8" rubber tires
- Universal stems hold both 1" male and 1 1/2" female style bases
- Rubber grip handle

1378676 Base Transport Cart **\$449⁹⁹** EA ★

SOFT TOUCH® BASES

MADE IN THE USA



SOFT TOUCH® TURF BASES

These bases are designed for use on synthetic playing fields with a turf depth of 1". This unique design requires no mounting system and sits securely on the synthetic turf. Easy to install, Soft Touch® for Turf bases can remain in-ground year round or set up specifically for game-time. Not for use on carpet style turf. Dimensions: 15 x 15 x 2.5. Made in the USA

1464786	Set of 3	\$1,465 ⁰⁰	SET
1464787	Single Base	\$575 ⁰⁰	EA
1464782	White and Orange 1st Base	\$1,148 ⁰⁰	SET
1464788	Home Plate	\$510 ⁰⁰	EA
1464789	Pitching Rubber	\$510 ⁰⁰	EA

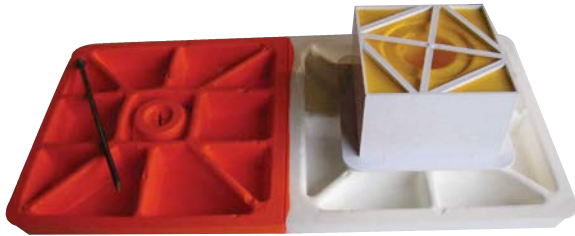

SOFT TOUCH® DOUBLE FIRST BASE

- White side anchored in ground mount, orange side anchored under the base with spikes.

1236293	\$709 ⁹⁹	EA
---------	---------------------	----

Softtouch™ double first bases are not a release style base due to double ground anchors.



SOFT TOUCH® PROGRESSIVE RELEASE BASE

- Designed to flex and absorb energy as a player slides into the base
- "Pops out" on the impact of short, hard slides
- Molded 7" stem fits over the orange play-plug and inside the ground mount

1. BBBASBRE	Complete 15" Single Base	\$314 ⁹⁹	EA
2. BBBREMNT3	Extra Ground Mounts - Set of 3	\$38 ⁰⁰	SET
3. 20026504	Extra Tapered Plugs - Set of 3	\$189 ⁹⁹	SET
BBBASAYP	Plugs (fills ground mounts) - set of 3	\$599 ⁹⁹	SET



SOFT TOUCH® CONVERTIBLE DOUBLE 1ST BASE

- Non-release style base
- Anchors into two ground anchors (not included)
- Male or female style

K13085	\$679 ⁹⁹	EA
--------	---------------------	----



SOFT TOUCH® CONVERTIBLE BASES

- Designed to fit into your existing 1" male or 1-1/2" female ground anchors (ground anchors not included)
- Progressive release bases are designed to flex and absorb energy
- In the case of a short slide, the base is designed to pop free from its mount

1236309	Set of 3 - 15" Bases with Mounting Tees	\$873 ⁰⁰	SET
---------	---	---------------------	-----

MacGregor **DOUBLE FIRST BASE**



DOUBLE FIRST BASE

- One-piece molded rubber base
- No stitches to tear or rip
- Set includes 2 ground anchors for installation

BBDFBSNR 30"L x 15"W x 3"H \$319⁹⁹ EA ★

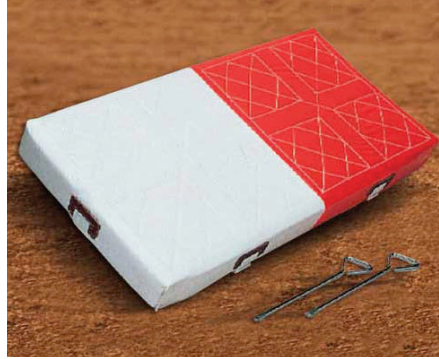

RECREATIONAL DOUBLE FIRST BASE

- Designed to reduce the chances of collisions, spiking and injuries
- Heavy duty vinyl covering with soft rebounded foam filler
- Comes with 2 straps, 2 buckles and 2 spikes

BBDBLFB3 Size - 30"L x 15"W x 3"H \$179⁹⁹ EA ★

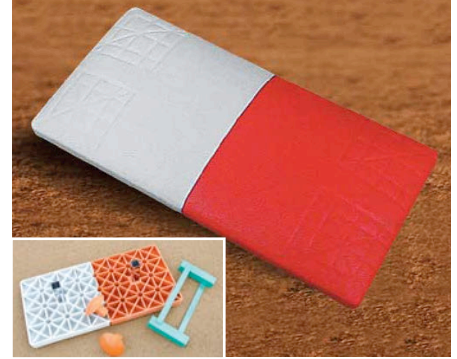

PREMIUM DOUBLE FIRST BASE

- One piece molded rubber base with simulated quilted top and steel stanchions
- Size - 30"L x 15"W x 3"H
- Weight: 33 lbs.

1235609 Set - Base, Anchor & Plugs \$449⁹⁹ EA ★
1235616 Repl. Anchor Only \$79⁹⁹ EA ★

MacGregor **INDOOR/PE BASES**



THROW DOWN BASES

- 5 piece orange rubber throw down home plate, pitcher's plate and three base set
- Ideal for both indoor and outdoor use
- Made of washable and flexible rubber

1235623 \$44⁹⁹ SET ★

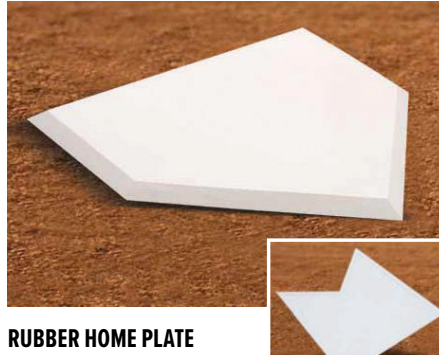

RUBBER HOME PLATE

- Official size with suction grip underside for use indoor and out.
- Heavy duty white molded rubber
- No spikes

BBSBHPXXY Home plate only \$34⁹⁹ EA ★
BBSBHPEX Home Plate Extension (17" x 13") \$54⁹⁹ EA ★

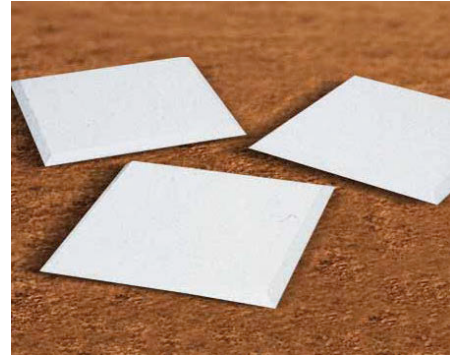

RUBBER BASES

- Solid white, heavy duty molded
- Rubber throwdown bases with suction grip underside
- For use indoor and out

BBSBBXXXY Set of 3 \$84⁹⁹ SET OF 3 ★
BBSBBEACY Single Base \$49⁹⁹ EA ★

MacGregor **BASE ACCESSORIES**



BIG LEAGUE BASE PLUGS (3-PACK)

BBBLPLUGPK \$62⁹⁹ PACK



ANCHOR CLEAN OUT TOOL

BBDIGOUT \$42⁹⁹ EA ★

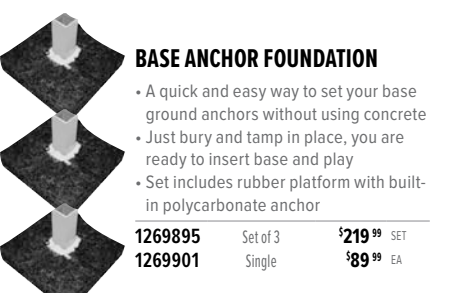

BASE ANCHOR FOUNDATION

- A quick and easy way to set your base ground anchors without using concrete
- Just bury and tamp in place, you are ready to insert base and play
- Set includes rubber platform with built-in polycarbonate anchor

1269895 Set of 3 \$219⁹⁹ SET
1269901 Single \$89⁹⁹ EA



UNIVERSAL RUBBER ANCHOR PLUG

BBRPLUGS \$12⁹⁹ EA ★



STANDARD GROUND ANCHORS

BBANCHOR \$79⁹⁹ SET OF 3 ★



HEAVY-DUTY BASEBALL/SOFTBALL BASE GROUND ANCHOR

BBMNAACH \$52⁹⁹ EA ★



JACK CORBETT® HOLLYWOOD BASES®

AVAILABLE AFTER APRIL 2023



**AUTHENTIC
COLLECTION.**

THE OFFICIAL BASE SUPPLIER TO
MAJOR LEAGUE BASEBALL®



JACK CORBETT® MLB® HOLLYWOOD BASE

RW12901010 Set of 3 Bases \$480.00

- Our extended, tapered lip virtually eliminates edge turn up.
- Engineered to better withstand bad weather and also includes special ultraviolet inhibitors.
- Added tensile strength to prevent most cuts and tears.
- Comes with 6" stanchions.
- Shipping Weight: 13 lb. (12901040)
- 15¼" X 15¼" X 2"
- Anchor plugs and ground anchors sold separately.

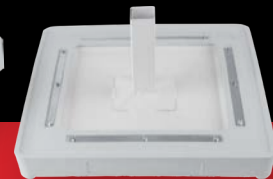
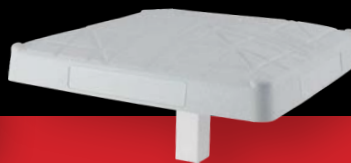

HOLLYWOOD IMPACT® BASE

RW12902040 Single Base \$138.00

- Premium, professional construction.
- Patented chevron design adds support and durability.
- Advanced base design compresses upon impact, reducing risk of ankle, leg and knee injuries.
- Comes with 6" stanchions.
- Shipping weight: 11 lb. (12902040)
- 14¾" X 14¾" X 2¼"
- Anchor plugs and ground anchors sold separately.



HOLLYWOOD SLIDER BASE

RW12905040 Set of 3 Bases \$474.00

- Features beveled corners and tapered base.
- Allows runners to slide over the base, reducing risk of injury.
- Solid, one-piece construction.
- Comes with 4" stanchion.
- Shipping weight: 16 lb. (12905030)
- Anchor plugs and ground anchors sold separately.

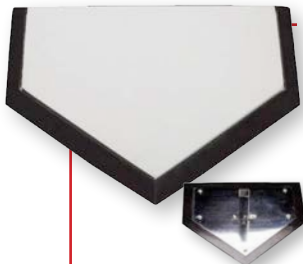

RAWLINGS PRO HOME PLATE

RW12807200 \$146.00

- Rugged, molded rubber construction.
- Mounted steel stanchion.
- Ground anchor included.
- Shipping weight: 17 lb.
- 20½" X 20½" X 1½"

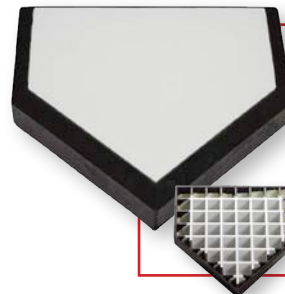

HOLLYWOOD BURY-ALL HOME PLATE

RW12908170 \$191.40

- Maximum strength, all rubber construction.
- No spikes needed for installation.
- Non-skid rubber surface.
- Ideal for permanent installation.
- Shipping weight: 24 lb.
- 3" thick.
- 20½" X 20½" X 3"

HOLLYWOOD 4-SIDED PROFESSIONAL PITCHING RUBBER



RW12909180 \$210.00

- Ultra-durable, premium molded rubber.
- Internal aluminum tube for professional strength.

GROUND ANCHOR MOUNT

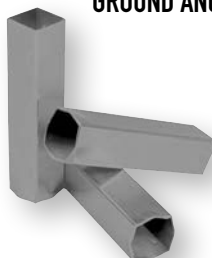

RW12916550 \$210.00

- 8" female ground anchor (1¾" square).
- Cleans easily with Rawlings Digout tool.
- Sold in sets of 3.
- Shipping Weight: 5 lb.

GROUND ANCHOR



RW227FAS \$210.00

- Female adapter. Color may vary.
- Built from high quality steel, zinc plated with special rust inhibitors.
- Dimensions:
1¾" X 1¾" (outside diameter)
1½" X 1½" (inside diameter) 77/8" (length)
- Shipping weight: 1 lb

AVAILABLE AFTER APRIL 2023

JACK CORBETT® HOLLYWOOD BASES®



HOLLYWOOD IMPACT® KWIK-RELEASE BASE

RW12906020 Youth Single Base \$250.00
RW12906040 Varsity Single Base \$270.00

- Premium, professional construction.
- Patented chevron design adds support and durability.
- Advanced base design compresses upon impact, reducing risk of ankle, leg and knee injuries.
- For additional safety precautions, the top of this base will disengage upon strong enough impact.
- Two resistance levels available: Youth and Varsity.
- Soft orange tabs on the platform are soft enough for players to slide over.
- Fully compliant with Little League® Rule 1.06.
- Ground plugs and anchors sold separately.
- Shipping weight: 23 lb. (12906020)
- 14¾" X 14¾" X 2¼"



HOLLYWOOD IMPACT® DOUBLE FIRST BASE

RW12902080 \$270.00

- Premium, professional construction.
- Patented chevron design adds support and durability.
- Advanced base design compresses upon impact, reducing risk of ankle, leg and knee injuries.
- Shipping Weight: 26 lb. (12902080)
- Includes 6" stanchions.
- Ground plugs and anchors sold separately.
- 30¼" X 15½" X 2"



HOLLYWOOD IMPACT® KWIK-RELEASE DOUBLE FIRST BASE

RW12906070 1 Double First Base, 2 Youth Bases \$860.00

- Premium, professional construction.
- Patented chevron design creates additional support and durability.
- Advanced base design compresses upon impact, reducing risk of ankle, leg and knee injuries.
- For additional safety precautions, the top of this base will disengage upon strong enough impact.
- Uses a single ground anchor.
- Soft orange tabs on the platform are soft enough for players to slide over.
- 30½" X 15½" X 2"





SINGLE WHEEL BB/SB PITCHING MACHINE

- Speed: 30-60 mph
- Throws baseballs, 11" and 12" softballs
- Runs on 110 volt AC or generator 1/4 HP D.C. motor
- Durable urethane wheel eliminates air pressure issues
- Heavy duty legs are convertible for baseball or softball

BBDOG1XX	Complete Unit	\$1,399⁹⁹ EA ★
BBDOG1WL	Replacement Wheel	\$479⁹⁹ EA ★

ELITE 2 WHEEL PITCHING MACHINE

- Throws curves, fastballs, sliders, sinkers and knuckleball
- Can throw pop-ups as well as grounders
- Pitch speed between 30 - 102 mph
- Urethane wheels eliminate air pressure problems
- Attached wheels for easy transport
- Best suited to throw dimple balls
- Weight: 95 lbs.

BULLELITEBB	Baseball Model	\$3,299⁹⁹ EA ★
BULLELITESB	Softball Version	\$3,299⁹⁹ EA ★
ZPMLEGSB	BB to SB conversion kit - Includes legs & chute	\$319⁹⁹ SET ★
ZPMLEGBB	SB to BB conversion kit - Includes legs & chute	\$319⁹⁹ SET ★



PROMOUNDS
MAJOR LEAGUE
GAME MOUND

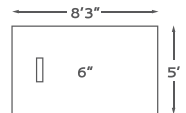

MAJOR LEAGUE GAME MOUNDS

- Made of high density foam & protected with Rubber Armor Technology.
- Converts your softball field into a baseball field
- Official Little League height specifications
- Great for indoor and outdoor use
- Lightweight, durable, portable
- Length allows pitching from the rubber and land on mound
- Please specify either green or red clay turf

MP3003	6"H x 60"W x 99"L	\$1,849⁹⁹ EA
---------------	-------------------	--------------------------------



FOUR PIECE GAME MOUND

- Meets all NCAA & MLB requirements
- Full regulation 18' fiberglass pitching mound
- 6 year warranty on fiberglass shell

1396130	18" Regulation	\$16,439⁹⁹ EA	
----------------	----------------	---------------------------------	--

APPROVED FOR TOURNAMENT & GAME USE BY



PORTABLE GAME MOUND

- Reinforced fiberglass and covered with AstroTurf
- 6 year warranty on fiberglass base
- Meets all specifications in mound slopes, diameter and table size

1450720	10"H x 10"W x 12'6"L	\$9,999⁹⁹ EA	
----------------	----------------------	--------------------------------	--

ALL MOUNDS AVAILABLE IN GREEN OR CLAY.



PORTABLE GAME MOUND

- Reinforced fiberglass and covered with AstroTurf
- Rubber landing pad included for added shell protection and performance
- 6 year warranty on fiberglass shell

BBPORTRE	Senior - 10"H x 10"W x 12'6"L	\$5,399⁹⁹ EA	
-----------------	-------------------------------	--------------------------------	--



TALLY COUNTER

- Hand held model
- Counts up to 9999

MSHTALLY	\$19⁹⁹ EA ★
-----------------	-------------------------------



RO SIN BAG

- High quality rosin in resealable polybag for long-lasting use.

5A162628	\$19⁹⁹ EA
-----------------	-----------------------------

MOUNDS

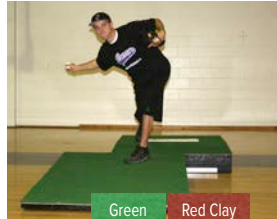

Green Turf
Red Clay Turf



Includes free measuring tape!



TWO PIECE PRACTICE MOUND

- 2-piece mound w/turf made with high density foam and protected with Rubber Armor Technology
- Skid proof, non-slip bottom - won't damage gym floors
- Used by NCAA Division 1 programs

MP2031 Size - 10"H x 4'W x 9'L \$1,749⁹⁹ EA

COACH'S CHOICE

PITCHER'S PLATFORM

- Protects field during batting practice
- Rugged aluminum frame
- Attached tires for easy portability
- Non-marking pads included for indoor use
- Mound height adjusts from 10" to 6"
- No flat tires

BSPROPLAT 7'L x 3'W x 10' 6" H \$1,499⁹⁹ EA



Includes free measuring tape!



PRACTICE MOUND WITH TURF

- Heavy duty polystyrene that is completely encased in a thick rubber coating for durability
- Rubber coating is skid resistant and will not damage gym floors
- Spike proof turf top will accommodate all cleats including metal

1237146 Size - 10"H x 5'W x 9'L \$1,999⁹⁹ EA
1237153 Size - 10"H x 4'W x 9'L \$1,849⁹⁹ EA



SOFTBALL PITCHERS MATS



JENNIE FINCH PITCHER'S LANE PRO

- Regulation pitching rubber attached and made from spike-resistant artificial turf with a no slip backing.
- Helps pitchers comply with NCAA regulations (Rule 2.19) that restricts pitchers from pitching outside the 24' pitching rubber.
- Comes with a free carrying case.

1291360 Size - 3'W x 10'L \$399⁹⁹ EA



PROMOUNDS JENNIE FINCH PITCHING MAT WITH POWERLINE

- Pitching mats made from spike-resistant/turf
- 2" wide inlaid white line for more precise training
- Regulation pitching rubber attached
- Comes with a convenient carrying case
- Non-skid bottom for gym floors

1266016 3'W x 10' L \$359⁹⁹ EA





OFFICIAL LEAGUE

- Leather cover
- Cork and rubber core
- Yarn windings
- Flat seams

BSOLBFS

Flat Seam

\$54.99 DZN ★



D1 PRO

- Full grain leather cover
- Cushioned cork center
- Grey wool windings
- Low seam (flat seam)

1385517

Flat Seam

\$154.99 DZN



FSR1 NCAA

- Official ball of the NCAA
- Full grain leather cover
- Cushioned cork center
- Wool windings
- Flat seam

1385512

Flat Seam

\$159.99 DZN



FSR100 NAIA

- Official ball of the NAIA
- Full grain leather cover
- Cushioned cork center
- Wool windings
- Flat seam

1385513

Flat Seam

\$149.99 DZN



A1030

- Grade C/D full grain leather
- Red cushioned cork
- Gray wool windings
- Flat seam

1385406

Flat Seam

\$99.99 DZN



A1010 PRO

- Grade A full grain leather
- Cushioned cork
- Premium gray wool windings
- Flat seam

1385405

Flat Seam

\$149.99 DZN





Wilson
A1010 BLEM

- Minor imperfections
- Full grain leather cover
- Cushioned cork center
- Great practice ball

WLWTA1010

\$79⁹⁹ DZN

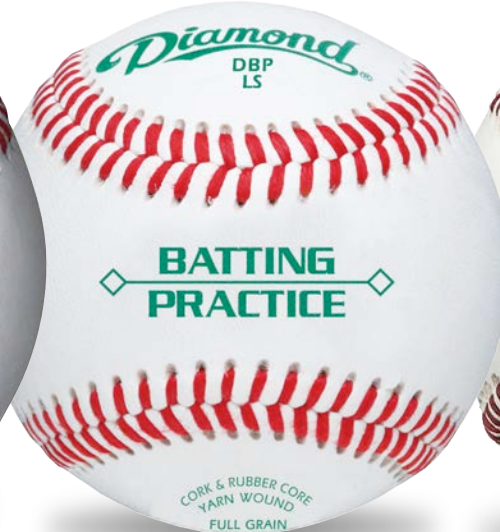

Diamond
DBP-FS

- Full grain leather cover
- Cork and rubber core
- Yarn windings
- Low seam (flat seam)

1385518

Flat Seam

\$104⁹⁹ DZN



41106 PRACTICE BASEBALL

- Full grain leather cover
- Cushioned cork center
- Improved grip for accuracy

WC41106HS

\$87⁹⁹ DZN



Rawlings
FSOLBX - PRACTICE

- Practice Ball
- Leather cover
- Flat seams

1385515

Flat Seam

\$109⁹⁹ DZN



Rawlings
ULTIMATE PRACTICE - RS

- Molded polyurethane cover
- Raised seams for improved grip
- HS batting practice baseball

RWR100-UP1

Raised Seam

\$149⁹⁹ DZN



Rawlings
ULTIMATE PRACTICE - FS

- Molded polyurethane cover
- Flat seam for improved grip
- Collegiate batting practice baseball

RWFSR100-UP

Flat Seam

\$217⁹⁹ DZN



MARK 1

OFFICIAL LEAGUE

- Leather cover
- Cork and rubber core
- Yarn windings
- Raised seams

1236002

\$52.99 DZN ★

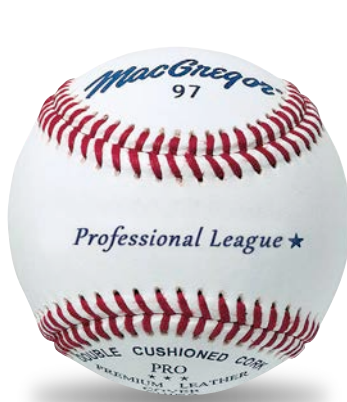

MacGregor
#97 PROFESSIONAL LEAGUE

- Cushioned cork center
- Grey english wool windings
- A grade leather cover
- Raised seams

MCB97PRO

\$86.99 DZN ★



MacGregor
#97 MAJOR LEAGUE

- Cushioned cork center
- Gray/white/gray yarn windings
- A grade leather cover
- Raised seams

MCB97MLH
MCB97MLX

NOCSE/NFHS Stamped
w/o NFHS Logo

\$86.99 DZN ★
\$86.99 DZN ★

NFHS
APPROVED



MacGregor
#79 PRACTICE

- Cork and rubber core
- Raised seams

MCB79PXX
MCB79PYX

Leather
Synthetic

\$56.99 DZN ★
\$39.99 DZN ★



MacGregor
#87SP OFFICIAL LEAGUE

- Cork and rubber center
- Split leather cover
- Raised seams

MCB87SPX

\$54.99 DZN ★



MacGregor
#87OL OFFICIAL LEAGUE

- Cushioned cork center
- Select wool windings
- Leather cover
- Raised seams

MCB87OLX

\$68.99 DZN ★



COACH'S CHOICE



Wilson
A1010 H.S. SST

NFHS
APPROVED

- Red cushion cork center
- Premium wool windings
- NOCSAE/NFHS Stamped

5A1010BHS1SST **\$134.99** DZN



Wilson
A1030B HS

- Cushioned cork center
- Grey wool windings
- Grade C leather cover
- Raised seams

5A1030B

\$99.99 DZN



SPALDING
PRO 100 NFHS

- Leather cover
- Cushioned cork center
- Raised seams
- NOCSAE/NFHS Stamped

WC41100HS

\$144.99 DZN



Wilson
A1010 PRO - NFHS

NFHS
APPROVED

- Grade A full grain leather
- Premium gray wool windings
- Raised seams
- Red cushioned cork center
- NOCSAE/NFHS Stamped

CCA1010BPRO

\$154.99 DZN



Diamond

DBP

- Cork and rubber pill
- A-Grade gray wool winding
- Premium leather cover
- Diamond Seam™

1159042 \$92.99 DZN

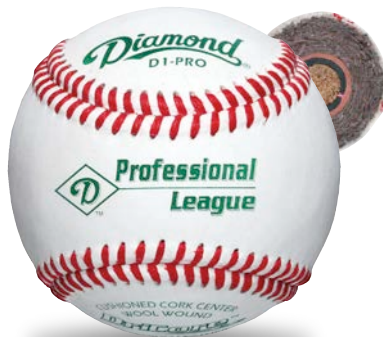

Diamond

D1-PRO

- Cushioned cork center
- A-1 grade wool winding
- Premium leather cover
- Diamond Seam™

1187359 \$144.99 DZN



Diamond

DOL-1 HS

- Cork & rubber core
- Yarn windings
- Full-grain leather cover
- NOCSAE/NFHS Stamped

1453927 \$102.99 DZN



Diamond

D1 PRO HS

- Cushioned cork center
- Finest grade grey wool windings
- Ultra-premium full-grain leather cover
- NOCSAE/NFHS Stamped

1453923 \$139.99 DZN



Diamond

DOL-A HS

- Cushioned cork center
- Yarn wound
- Full-grain leather cover
- NOCSAE/NFHS Stamped

1453926 \$112.99 DZN



Diamond

D1 HS

- Cushioned cork center
- Grey wool windings
- Premium full-grain leather cover
- NOCSAE/NFHS Stamped

1453924 \$129.99 DZN



Baden

3B-NFHS

- Premium Leather cover
- Performance seams
- Ballistic windings
- NOCSAE/NFHS Stamped

1362015 \$119.99 DZN

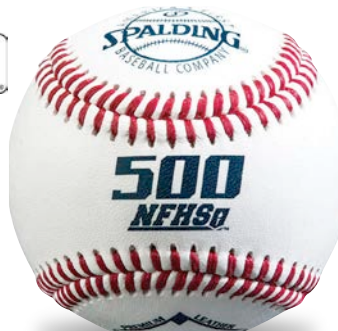

SPALDING

PRO 500

- Leather cover
- Gray wool windings
- Cushioned cork center
- NOCSAE/NFHS Stamped

WC41101HS \$119.99 DZN



Rawlings

R100 H3

- Full grain leather cover
- Raised seam for improved grip
- Cushioned cork center
- Wool windings
- NOCSAE/NFHS Stamped

RWR100H3 \$126.99 DZN



**CUSTOM
BASEBALL
PROGRAM**
CALL FOR MORE
INFORMATION



Little League®



MacGregor

#76C

- Cushioned cork center
- Select wool windings
- C Grade Leather cover
- Raised seams / RS-T stamped

MCB76CXX C Grade Cover \$65⁹⁹ DZN ★



Rawlings

RLLB

- Full grain leather cover
- Raised seams
- RS-T stamped

1055740 Cushioned Cork \$104⁹⁹ DZN

1055757 Cork & Rubber \$72⁹⁹ DZN



MacGregor

#76C1

- Cork and rubber center
- Select wool windings
- Raised seams

MCB76C1X Leather Cover \$64⁹⁹ DZN ★



Diamond

DLL-1

- Little League competition grade baseball
- Premium leather cover
- Raised seams

1159103 Cork & Rubber \$84⁹⁹ DZN

1159097 DLL Cushioned Cork \$109⁹⁹ DZN



SPALDING

LITTLE LEAGUE

- Leather cover
- Cushioned cork center
- Gray wool windings

WC41102LL RS-T Stamp \$89⁹⁹ DZN



Wilson

A1074BSST

- Red cushion cork center
- Grey wool windings
- Raised seams

5A1074BLL1 C Grade Cover \$99⁹⁹ DZN



Diamond

DSLL-1 SENIOR LEAGUE

- Cork and rubber pill center
- Select wool blend winding
- Premium leather cover
- Diamond Seam™

1159127 \$99.99 DZN



MacGregor

#73C SENIOR LEAGUE

- Cushioned cork center
- Select wool windings
- Leather cover
- Raised seams

MCB73CXX \$67.99 DZN ★



Rawlings

RSL

- Cushioned cork center
- Full grain leather cover
- Raised seams
- RS-T stamped

1055764 RSL \$109.99 DZN

PRACTICE BALL

TEE BALL



Rawlings

ULTIMATE PRACTICE BALL

- Molded polyurethane cover
- Raised seams for improved grip
- Designed for youth practice

RWR100-UPY \$74.99 EA

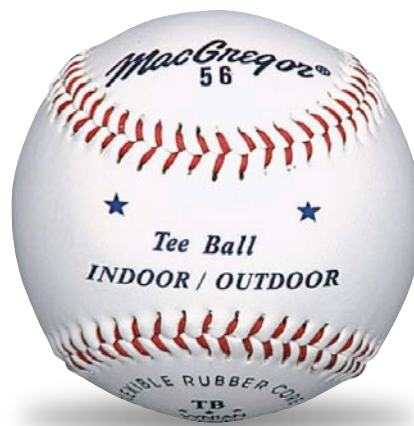

MacGregor

#56 OFFICIAL TEE BALL

- "Vyntan" synthetic leather cover
- Low bounce rubber core
- Double-stitched seams
- Ideal for tee ball & indoor or outdoor training

MCB56TBX \$64.99 DZN ★

**CUSTOM
BASEBALL
PROGRAM**
CALL FOR MORE
INFORMATION



BABE RUTH



MacGregor

#74 OFFICIAL BABE RUTH®

- Cushioned cork center
- Select wool windings
- Leather cover
- Raised seams

MCB74CXX \$64⁹⁹ DZN ★



Rawlings

RBRO(1) BABE RUTH®

- Cushioned cork center
- Leather cover
- Raised seams

1055771 RBRO \$102⁹⁹ DZN
1055788 RBRO1 \$79⁹⁹ DZN



Diamond

DBR-1 BABE RUTH

- Cork and rubber pill
- Select wool blend winding
- Premium leather cover
- Competition grade baseball

1159080 \$104⁹⁹ DZN



CAL RIPKEN



MacGregor

#74 CAL RIPKEN®

- Cork and rubber center
- Select wool windings
- Leather cover
- Raised seams

MCB74CAL \$61⁹⁹ DZN ★



Rawlings

RCAL CAL RIPKEN TOURNAMENT

- Cushioned cork center
- 15% wool windings
- Full-grain leather cover
- Raised seams

RWRCAL \$109⁹⁹ EA



Rawlings

RCAL1 CAL RIPKEN®

- Cork and rubber center
- Full grain leather cover
- Raised seams

1055795 \$77⁹⁹ DZN



USSSA



Rawlings

ROLB1 - USSSA

- Cork and rubber center
- Full grain leather cover
- Raised seams
- USSSA approved

1055801 ROLB1 \$69⁹⁹ DZN
1055818 ROLB1X \$69⁹⁹ DZN



Wilson

A1030 USSSA

- Cushioned cork center
- Gray wool yarn
- Grade C leather cover
- Raised seam

1195279 \$99⁹⁹ DZN



PONY

**CUSTOM
BASEBALL
PROGRAM**
CALL FOR MORE
INFORMATION



Rawlings RPLB1 PONY LEAGUE

- Cork and rubber center
- Full grain leather cover
- Raised seams

1420274 \$79⁹⁹ DZN



Diamond DPL PONY LEAGUE

- Cushioned cork center
- A-Grade gray wool winding
- Premium leather cover
- Tournament grade

1159059 \$99⁹⁹ DZN



MacGregor #75 OFFICIAL PONY®

- Cushioned cork center
- Select wool windings
- Leather cover
- Raised seams

MCB75CXX \$74⁹⁹ DZN ★



MacGregor #75CY YOUTH PONY®

- Cork and rubber center
- Select wool windings
- Leather cover
- Raised seams

MCB75CYX \$61⁹⁹ DZN ★



DIXIE



Diamond DDY-1 DIXIE YOUTH

- Cork and rubber pill
- Select wool blend winding
- Premium leather cover
- Diamond Seam™

1159141 \$94⁹⁹ DZN



MacGregor #78 DIXIE® BOYS & MAJORS

- Cushioned cork center
- Select wool windings
- Leather cover
- Raised seams

MCB78CXX \$65⁹⁹ DZN ★



MacGregor #72 DIXIE® YOUTH

- Cork and rubber center
- Select wool windings
- Leather cover
- Raised seams

MCB72CXX \$68⁹⁹ DZN ★



DIZZY



Rawlings RZDY1 DIZZY DEAN

- Cork and rubber center
- Full grain leather cover
- Raised seams

1419932 \$77⁹⁹ DZN

SAFETY



MacGregor SAFE/SOFT BASEBALL

- 3 LEVELS OF SAFETY FOR ALL AGES
- Meets NOCSAE standard
- Leather cover with patented Tri-Flex safety core
- Raised seams

MCB5SV01	Level 1 Ages 5 - 7	\$84 ⁹⁹ DZN ★
MCB5SV05	Level 5 Ages 8-12	\$84 ⁹⁹ DZN ★
MCB5SV10	Level 10 Ages 12+	\$84 ⁹⁹ DZN ★

**BEST
SELLER**



**MacGregor
LITTLE LEAGUE®**

- League approved / stamped
- COR .47/375 lb max comp.
- Poly graphite center
- Synthetic leather cover

MCSB11LLY	11"	\$114⁹⁹ DZN ★
MCSB12LLY	12"	\$114⁹⁹ DZN ★

MARK 1

NFHS

**NFHS®
APPROVED**

- 12" NFHS approved
- COR .47/375 max comp.
- Leather cover
- Raised stitch
- Poly-core

1236026	12"	\$96⁹⁹ DZN ★
----------------	-----	--------------------------------



PRACTICE

- Slowpitch or fastpitch
- COR, compression, cover, center may vary

5PSBY11	11"	\$85⁹⁹ DZN ★
5PSBY12	12"	\$85⁹⁹ DZN ★

BATTING PRACTICE

EVIL SPORTS



BATTING PRACTICE

- .44 COR
- 400 Comp
- Leather cover
- Red stitches

1394802	12"	\$89⁹⁹ DZN
----------------	-----	------------------------------



**MacGregor
ASA®**

- ASA® approved
- Cor. .47 / 375 lb max comp
- Poly graphite center
- Leather cover
- Red stitch

MCSB11YL	11"	\$114⁹⁹ DZN ★
MCSB12YL	12"	\$114⁹⁹ DZN ★



**MacGregor
NFHS - FP**

NFHS - FP

**NFHS®
APPROVED**

- .47 COR
- 375 Comp
- Poly graphite center
- Leather cover
- Red stitch

MCSB12YH	12"	\$114⁹⁹ DZN ★
-----------------	-----	---------------------------------



TRUMP

NFHS/ASA - FP

**NFHS®
APPROVED**

- .47 COR
- 375 Comp
- Leather cover
- Red Stitch

1394818	12"	\$106⁹⁹ DZN
1394817	11"	\$106⁹⁹ DZN



BATTING PRACTICE

- .52 COR
- 300 Comp
- Leather cover
- Black stitch

1394803	12"	\$89⁹⁹ DZN
----------------	-----	------------------------------



**MacGregor
PONY®**

- Pony approved
- COR .47/375 lb max comp.
- Poly graphite center
- Leather cover

MCSB11PNY	11"	\$109⁹⁹ DZN ★
MCSB12PNY	12"	\$109⁹⁹ DZN ★



Wilson

A9011 - NFHS FP

**NFHS®
APPROVED**

- .47 COR
- 375 lb Max Comp.
- Leather Cover
- Red SST Stitching

5A9011BSST	12"	\$149⁹⁹ DZN
-------------------	-----	-------------------------------



Baden

PERFECTION - NFHS FP

**NFHS®
APPROVED**

- .47 COR
- 375 lb max comp.
- Leather cover
- Poly core

1323429	12"	\$149⁹⁹ DZN
----------------	-----	-------------------------------



MacGregor

SAFE/SOFT TRAINING

- Perfect for drills
- Leather cover
- Tri-Flex safety core

MCSB11SS	11"	\$114⁹⁹ DZN ★
MCSB12SS	12"	\$114⁹⁹ DZN ★

DUDLEY SOFTBALLS



4U-542Y-THUNDER SY CLASSIC W-SP

- USSSA approved
- .44 COR
- 400 Comp.
- Classic W stamped
- Synthetic cover

1300291 11" \$94⁹⁹ DZN



4A-068Y-THUNDER ZN HYCON-SP

- ASA approved
- .52 COR
- 375 Comp
- Composite cover
- Red Stitch

1375626 12" \$119⁹⁹ DZN



4U541Y-THUNDER SY USSSA-SP

- USSSA approved
- .40 COR
- 325 Comp.
- Classic M stamped
- Synthetic cover

1265996 12" \$109⁹⁹ DZN



NFHS APPROVED

43-147-THUNDER HEAT NFHS-FP

- NFHS approved
- .47 COR
- 375 Comp.
- Poly graphite center
- Leather cover

BBDNHFSY 12" \$139⁹⁹ DZN



4A-069Y-ASA THUNDER SY HYCON-SP

- ASA Approved
- .52 COR
- 300 Comp
- Synthetic cover
- Red stitch

1375627 12" \$109⁹⁹ DZN



4E-824Y THUNDER SY-FP

- NSA Approved
- .44 COR
- 375 Comp
- Synthetic cover
- ICON Stamp

1453914 12" \$94⁹⁹ DZN
1453915 11" \$94⁹⁹ DZN



43-184Y-THUNDER ADVANCE MLT-SP

- Non-association ball
- .44 COR
- 375 Comp.
- Advance MLT series tech.
- Composite cover
- Blue stitch

1300284 12" \$119⁹⁹ DZN



4A-065Y-ASA THUNDER HEAT HYCON-SP

- ASA approved
- .52 COR
- 300 Comp
- Leather cover
- Red stitch

1375625 12" \$129⁹⁹ DZN

WORTH SOFTBALLS



SUPER GOLD DOT CLASSIC SLOW PITCH

- USSSA approved
- .40 COR
- 325 Comp.
- Pro Tac cover
- Poly-core with C-Lok technology

1265774 12" \$109⁹⁹ DZN



BLUE DOT SLOW PITCH

- Not ASA approved
- .47 COR
- 525 Comp.
- Pro Tac cover
- Poly graphite center

1193930 12" \$109⁹⁹ DZN



HOT DOT SLOW PITCH

- ASA Approved
- .52 COR
- 300 Comp
- Red stitch
- C-LOK technology

1385211 12" \$109⁹⁹ DZN

Rawlings SOFTBALLS



RED DOT FAST PITCH

- ASA/NFHS Approved
- .47 COR
- 375 Comp
- Leather cover
- 88 red stitch
- Poly X core

RWPX2RYLAH 12" \$134⁹⁹ DZN



DREAM SEAM FAST PITCH

- ASA/NFHS approved
- .47 COR
- 375 Comp
- High-density cork core
- Optic yellow cover
- 88 red stitch

RWC12RYLAH 12" \$129⁹⁹ DZN
RWC11RYLA 11" \$129⁹⁹ DZN



OFFICIAL NCAA CHAMPIONSHIP FAST PITCH

- Official NCAA championship ball
- .47 COR
- 400 Comp
- Polycore center
- Pro leather cover
- Raised seam, red stitch

RWNC12L 12" \$179⁹⁹ DZN

**CUSTOM
BASEBALL
PROGRAM**
CALL FOR MORE
INFORMATION

ASA



EVIL SPORTS

ASA

- .52 COR
- 300 Comp
- Leather cover
- Red stitch

1394793 12" **\$114⁹⁹** DZN



**THE ROCK.
ROCK - ASA**

- .52 COR
- 300 Comp
- Composite cover
- Red Stitch

1394808 12" **\$109⁹⁹** DZN



EVIL SPORTS

ASA

- .44 COR
- 375 Comp
- Leather cover
- Red stitch

1394792 12" **\$104⁹⁹** DZN



**THE ROCK.
ASA**

- .44 COR
- 375 Comp
- Composite cover
- Red stitch

1394807 12" **\$109⁹⁹** DZN
1394806 11" **\$109⁹⁹** DZN



MacGregor

ASA

- ASA approved
- COR 52/300 max. comp
- Poly graphite core
- Red stitching

1377375 12" - Synthetic Cover **\$80⁹⁹** DZN ★
1377376 12" - Composite Cover **\$89⁹⁹** DZN ★
1377377 12" - Leather Cover **\$109⁹⁹** DZN ★



MacGregor

ASA

- ASA[®] approved
- COR .44 / 375 lb max comp.
- Yellow leather cover
- Red stitching
- Compressed cork core

1280517 11" **\$89⁹⁹** DZN ★



TRUMP

ASA

- .44 COR
- 375 Comp
- Synthetic leather cover
- Red stitch

1394814 12" **\$84⁹⁹** DZN
1394813 11" **\$84⁹⁹** DZN

USSSA



EVIL SPORTS

USSSA

- .40 COR
- 325 Comp
- Leather cover
- Blue stitch

1394795 12" **\$104⁹⁹** DZN



TRUMP

USSSA

- .40 COR
- 325 Comp
- Synthetic cover
- Blue Stitch

1394816 12" **\$89⁹⁹** DZN



EVIL SPORTS

USSSA

- .52 COR
- 275 Comp
- Leather cover
- Blue stitch

LD806AKEZCLASWYO 11" **\$99⁹⁹** DZN



**THE ROCK.
USSSA**

- .52 COR
- 325 Comp
- Composite cover
- Blue Stitch

1394810 12" **\$109⁹⁹** DZN



**THE ROCK.
USSSA**

- .44 Cor
- 400 Comp
- Composite cover
- Blue Stitch

1394809 11" **\$109⁹⁹** DZN

EVIL SPORTS

**EVIL NSA 12"
44/400-LEATHER**

- .44 COR
- 400 comp
- Leather cover

1453231 12" \$84⁹⁹ DZN



**THE ROCK.
XROCK NSA 12"
44/400-COMPOSITE**

- .44 COR
- 400 Comp
- Composite cover

1453235 12" \$84⁹⁹ DZN ★



**THE ROCK.
NSA**

- .52 COR
- 275 Comp
- Black Stitch

1394812 12" \$99⁹⁹ DZN



SSUSA

TRUMP

SSUSA

- 44COR
- 375 Comp
- Micro-cell cover

1453886 12" \$74⁹⁹ DZN ★



ISA

**THE ROCK.
ROCK - ISA**

- Composite cover
- 44 COR
- 400 comp

1453228 12" \$74⁹⁹ DZN ★



NON SANCTIONED

EVIL SPORTS

44 MAX

- .44 COR
- 525 Comp
- Blue stitch

1394797 12" \$94⁹⁹ DZN



EVIL SPORTS

ULTIMATE EVIL

- .53 COR
- 500 Comp
- Red/Orange stitch

1394800 12" \$86⁹⁹ DZN



SPECIALTY BALLS

16"

9"

12"



UNBELIEVA-BALL

- State of the art, sting free and safe!
- Made of a high density foam core surrounded by nylon windings and a heavy duty cloth cover.
- Raised seams for a more realistic feel.
- Machine washable and long lasting.
- Perfect training aid for both indoor and outdoor play.

1300932	9" Baseball - White	\$99 ⁹⁹ DZN ★
1300949	11" Softball - Yellow	\$114 ⁹⁹ DZN ★
1300956	12" Softball - Yellow	\$119 ⁹⁹ DZN ★
1300963	12" Softball - White	\$119 ⁹⁹ DZN ★
1300970	16" Softball - White	\$34 ⁹⁹ EA ★

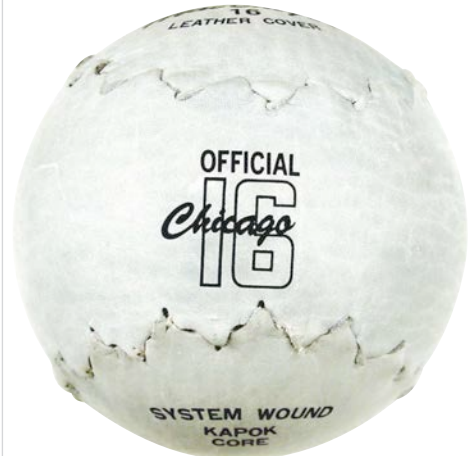

SOFTOUCH™ INCREDI-BALL®

- Features a unique safety core for limited flight and reduced injuries
- Polyurethane core with durable synthetic leather cover
- Perfect for younger game play or indoor/outdoor training for all ages

BBST9W	9" Baseball - White	\$86 ⁹⁹ DZN
BBST11Y	11" Softball - Neon	\$97 ⁹⁹ DZN
BBST12Y	12" Softball - Neon	\$99 ⁹⁹ DZN



SOFTSTITCH™ INCREDI-BALL®

- INCREDI-BALL™ sting free, safe, softwound balls with a lockstitch, double-knit cover.
- Washable, and will last as long as a regular ball.
- Carries 75% of distance when hit.
- A great training aid for indoors or outdoors.

BBSS9W	9" Baseball - White	\$85 ⁹⁹ DZN
BBSS11Y	11" Softball - Yellow	\$89 ⁹⁹ DZN
BBSS12Y	12" Softball - Yellow	\$89 ⁹⁹ DZN



CHICAGO 16"

- Leather
- COR .47
- Kapok center

MCSB16CH	16"	\$34 ⁹⁹ EA ★
-----------------	-----	------------------------------------

PITCHING MACHINE BALLS



SUPER SOFT TRAINING BALL

- Compare to SFT® Supersoft™ balls
- Perfect indoor training ball

1155020	9" Baseball	\$64⁹⁹ DZN ★
1155037	12" Softball	\$68⁹⁹ DZN ★



MacGregor® DIMPLED MACHINE BALLS

- Soft, durable yellow polyurethane
- Designed safe for aluminum bats

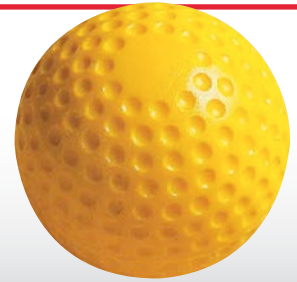

MCBDBYEL	9" Baseball	\$62⁹⁹ DZN ★
BBDSBALL	12" Softball	\$84⁹⁹ DZN ★

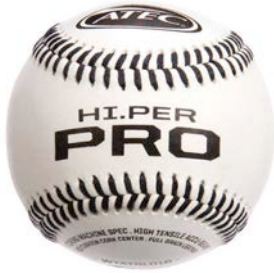

HI.PER PRO LEATHER MACHINE BASEBALL

- Premium full grain leather balls with cushioned cork center
- High tensile strength accu-seams
- Regulation size and weight
- Aerodynamically optimized for pitching machine use

K15837		\$129⁹⁹ DZN
---------------	--	-------------------------------



SEAMED PITCHING MACHINE BALLS

- Patented red seamed dimpled pitching machine ball
- Inset seams will not come in contact with machine wheels protecting red seams from wear
- Baseball appearance trains batter's eye for the real pitch

1237269	9" White Baseball	\$74⁹⁹ DZN
1237276	12" Yellow Softball	\$77⁹⁹ DZN



LITE MACHINE BALLS WITH SEAMS

- Compare to ATEC SFT® balls
- Ideal training ball for all ages
- Designed safe for indoor/outdoor
- Will travel as far as a regulation ball
- Works in most pitching machines

1155006	9" Baseball	\$76⁹⁹ DZN ★
----------------	-------------	--------------------------------

TRAINING BALLS



PLASTIC 'CURVE' BALL

Unique hole design allows for easy curveball action.

3192XXX	12" Softball	\$2⁷⁹ EA
----------------	--------------	----------------------------



PLASTIC TRAINING BALLS

- Designed for true slow and limited flight

1033601	9" Baseball	\$23⁹⁹ SET OF 6 ★
1033618	12" Softball	\$25⁹⁹ SET OF 6 ★



9" WIFFLE™ BALL BASEBALL

Designed for true slow and limited flight. 9" baseball size.

1141245	Wiffle™ 9" Baseball	\$3⁹⁹ EA
----------------	---------------------	----------------------------



TCB SUPER WEIGHTED BALLS

- Approx. 5.2"D - Softball size
- Weighs 900 grams
- Use for soft toss or tee work
- Strength development for the core and upper body

K10707	TCB Atomic Balls (set of 6)	\$84⁹⁹ SET
---------------	-----------------------------	------------------------------



TCB TRAINING BALLS

- Approx. 3.2"D - Baseball Size
- Used for soft toss, front toss and tee work
- Helps players "drive-thru" the hitting zone
- Ball weighs 425 grams

K10704	Weighted	\$109⁹⁹ DZN
---------------	----------	-------------------------------



TCB TRAINING BALLS

- Perfect for front toss drills
- Great for hand eye coordination
- Hits better, throws better than ordinary plastic balls
- Designed to last

K10705	With Holes - Golf Ball Size	\$47⁹⁹ DZN
K10706	With Holes - Standard 3.2"	\$62⁹⁹ DZN



1. BUCKET W/ BASEBALLS

- Bucket with 3 dz. MacGregor 79P practice baseballs (MCB79PXX)
- 6 gallon plastic bucket w/ cushioned lid
- Holds up to 5 dz. baseballs or 2 dz. softballs

1378434 Bucket w/ balls \$197.99 EA ★
1378437 Bucket Only \$44.99 EA ★

2. BUCKET W/ MARK 1 BALLS

- Bucket with 3 dz Mark 1 Official League Baseballs (BSOLB)
- Heavy duty 6 gallon plastic bucket with cushioned lid

1378435 Bucket w/balls \$204.99 EA ★

3. BUCKET W/ SOFTBALLS

- 2 dz. practice softballs
- COR, compression, cover, center and brand of balls may vary.

1378432 11" \$174.99 EA ★
1378433 12" \$169.99 EA ★

BSN SPORTS FOLDING BALL CART

- Holds approx 100 baseballs and 50 softballs
- Removable ball bag
- Stand designed for throwing batting practice
- Includes stand and legs

1453880 3' H \$94.99 EA

EASTON COACH'S BUCKET COVER

- Includes soft cushioned top, pockets for pens & line-up cards, a zipper pocket, and a mesh pocket for three game balls

1237238 \$44.99 EA

Diamond BALL BUCKET

- Holds up to 5 dz baseballs
- Padded seat for comfort

1404890 \$52.99 EA

COACH'S CHOICE

BATTING PRACTICE BALL CART

- Constructed of 1.5" O.D. powder coated steel
- Large capacity basket
- Oversized "no flat" tires
- 15"H x 15"W x 15"L

1378683 Batting Practice Ball Cart \$399.99 EA ★
240210NF75 Replacement Wheel \$49.99 EA ★

BALLS NOT INCLUDED

FOLDABLE BALL BIN

- Waist high ball bin-ideal for soft toss or normal BP
- Foldable design allows for easy storage
- Holds over 100 baseballs or over 50 softballs

1361841 \$299.99 EA ★

BALLS NOT INCLUDED

ADJUSTABLE FIELD BALL CART

- Heavy duty molded plastic hopper and large rear wheels for easy mobility
- Legs are height adjustable to raise/lower hopper height
- Holds 200 baseballs/100 softballs

1237207 \$619.99 EA

MacGregor

OFFICIAL BATTING TEE

- Constructed of durable rubber components
- Features a solid metal base for added weight
- Adjustable hitting height from 20" to 36"
- Ideal for training players of all ages

BBBATTEE9	Black Tee	\$59 ⁹⁹ EA ★
BBBATTUB9	Black Replacement Inside Tube	\$19 ⁹⁹ EA ★

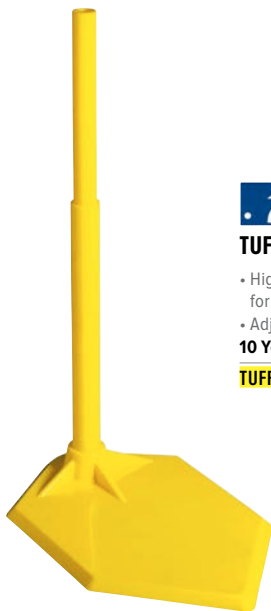
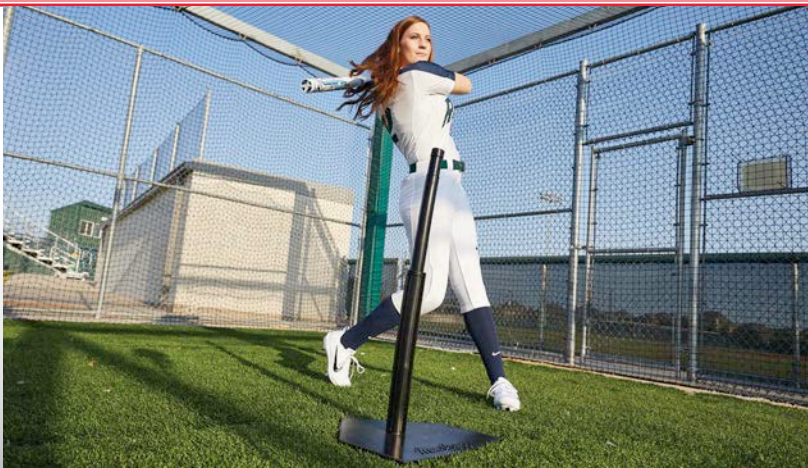

TUFFY® TEE

- High strength polyurethane materials for unmatched durability
- Adjusts from 20" to 39"
- **10 Year Limited Warranty**

TUFFTEE1	Single Tee	\$169 ⁹⁹ EA
-----------------	------------	------------------------

VARSITY 5 POSITION BATTING TEE

- Rugged hard-rubber construction
- Learn to control ball contact points for inside, outside and down the middle
- Allows over 20 different drill positions
- Adjustable from 20" - 39"
- **10 Year Limited Warranty**

1154818	Complete Tee	\$109 ⁹⁹ EA ★
1249897	Replacement Top Tube	\$24 ⁹⁹ EA ★



THE PVTEE

- Flexible pivot joint will have the tee back to the upright position before you are ready to put the next ball on
- Pivot joint allows impact of mis-hits to be realized in the joint and not the other tee components
- Flexible pivot joint takes impact away from batters hands and helps eliminates bat damage
- Unique magnet allows the tee to break down in one second
- Weighted base holds tee in place
- One year limited warranty

1393592	Standard Tee (27"-47")	\$159 ⁹⁹ EA
1393597	Low Stem Only (20"-26")	\$74 ⁹⁹ EA

COACH'S CHOICE



TANNER TEES

TANNER TEE

- Steel shaft has telescoping height adjustment
- Flexible ball rest for minimal resistance
- Breaks down easy for travel

K11059	Standard Tee (26"-43")	\$109 ⁹⁹ EA
K11060	Short Tee (20"-32")	\$109 ⁹⁹ EA

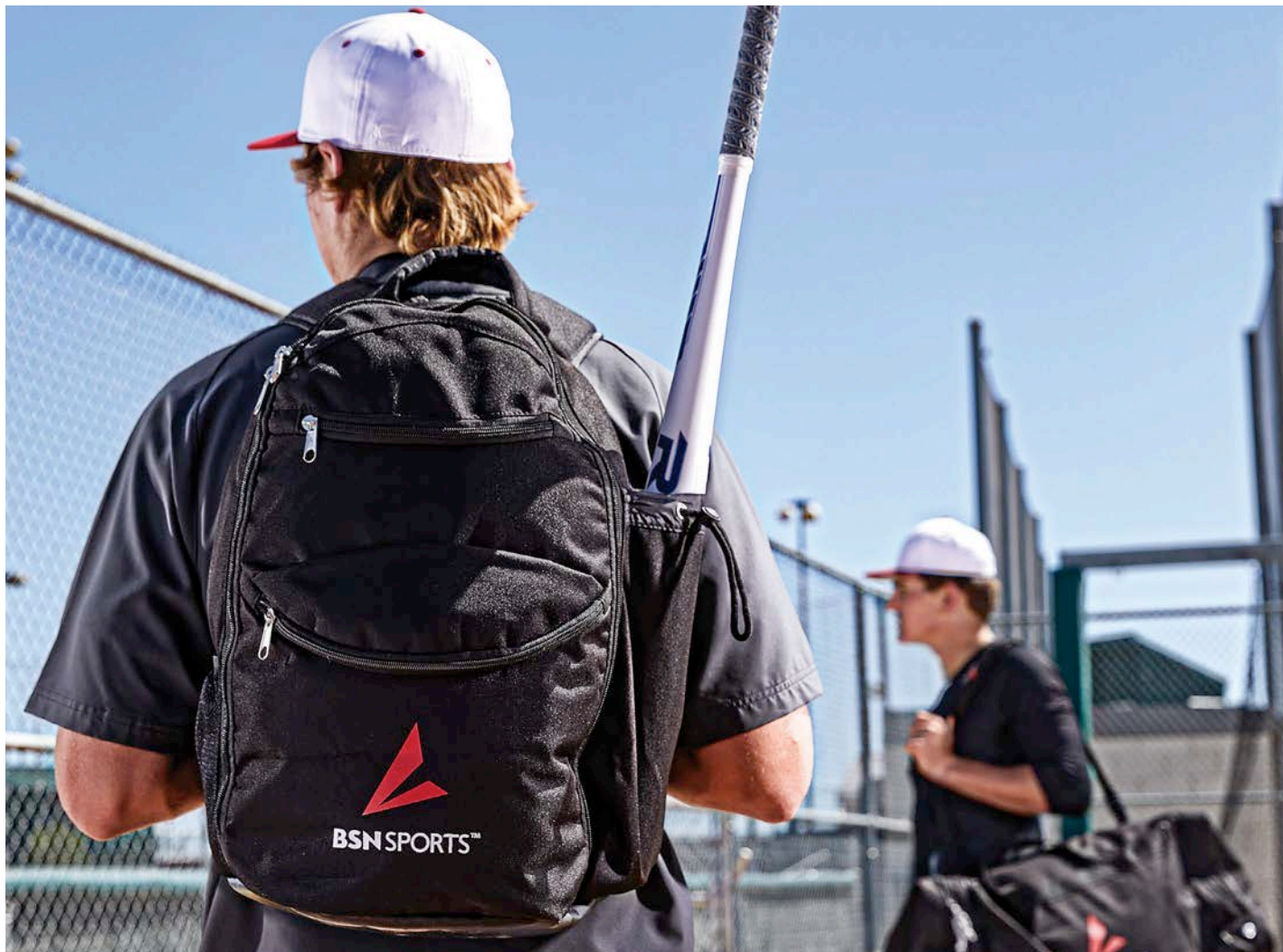

XL DUFFLE EQUIPMENT BAG

- Breathable heavy duty cotton canvas
- Durable leather reinforced bottom
- Complete with shoulder strap and handle
- Black only



1385404 42"L x 20"W \$59⁹⁹ EA ★

BALL BAG

- Coated nylon with heavy duty carrying straps and zippered top
- Durable plastic bottom provides long lasting protection against water damage and mildew
- Holds 48 baseballs or 24 softballs
- Black only



1385399 \$54⁹⁹ EA ★



TEAM EQUIPMENT BAG

- Heavy duty polyester equipment bag
- Rugged nylon zipper with wrap around handles
- Black only



1377678 33"L x 12"W x 15"H \$31⁹⁹ EA ★

CATCHER'S EQUIPMENT BAG

- Heavy duty 600D polyester construction
- Professional strength carry straps
- Black only



1385403 35"L x 25"W x 19"H \$69⁹⁹ EA ★



LARGE DUFFLE EQUIPMENT BAG

- Durable 600 denier polyester bag with a thick web shoulder strap and handle
- Military style closure
- Black only

1385397 33"L x 18"W \$54.99 EA ★



TEAM DUFFLE BAG

- Zip close compartments on both ends
- Double handle carry straps
- Padded shoulder harness
- Denier nylon with breathable air vents
- Black only

1377672 27"L x 14"W x 12"H \$69.99 EA ★

1377675 24"L x 12"W x 10"H \$52.99 EA ★



BASEBALL/SOFTBALL EQUIPMENT TOTE

- Strong 600 denier polyester
- Will hold 15 bats and has a zippered top for easy closing
- Separate zippered outside pocket for softballs or baseballs
- Double reinforced bottom with standard shoulder straps
- Black only

1385398 39"L x 12"W \$64.99 EA ★



PLAYERS BAT PACK

- Mid-sized backpack
- External side sleeves
- Interior room for a batting helmet and other gear
- 600D polyester construction
- Black only

1385392 14"L x 10"W x 19"H \$39.99 EA ★



VARSITY BAT BAG

- Tough vinyl material with a molded plastic round bottom
- The plastic bottom helps prevent tearing caused by dragging the bag
- Can hold up to 10 bats
- Black only

1385396 41"L x 10"W \$54.99 EA ★



TEAM ROLLER BAG

- 600 denier polyester shell
- Concealed pull handle
- Padded shoulder strap
- In-line wheel kit
- Oversized accessory pockets on both ends

Color Options: **Black, Royal, Scarlet.**

1385400 38"L x 16"W x 15"H \$159.99 EA ★

CATCHER'S GEAR PACKS

All available in

BLACK

ROYAL

SCARLET



JUNIOR CATCHER'S GEAR PACK

- Adjustable catcher's helmet
- MCB75 junior chest protector
- Junior double knee leg guards
- 4" throat protector

\$169⁹⁹

1186895 Ages 5-8 **\$169⁹⁹** PACK ★



YOUTH CATCHER'S GEAR PACK

- Adjustable catcher's helmet
- MCB74 youth chest protector
- Youth double knee leg guards
- 4" throat protector

\$189⁹⁹

1186833 Ages 9-12 **\$189⁹⁹** PACK ★



PREP CATCHER'S GEAR PACK

- Pro style varsity catcher's helmet
- MCB73 prep chest protector
- Prep double knee guards
- 4" throat protector

\$279⁹⁹

1186864 Ages 12-15 **\$279⁹⁹** PACK ★



ADULT CATCHER'S GEAR PACK

- Pro-style adult catcher's helmet
- MCB70 adult chest protector
- Varsity double knee leg guards
- 4" throat protector

\$289⁹⁹

1186802 Ages 15+ **\$289⁹⁹** PACK ★

CATCHER'S HELMETS



Rawlings

HOCKEY STYLE CATCHER'S HELMET

- Meets revised NOCSAE standards
- Hockey style design - features rugged, durable ABS shell
- Dual foam liner with vents large air vents
- One size fits most

Color Options: **Black, Royal, Scarlet.**

1383962 Fits Sizes 6 1/2 - 7 1/2 **\$117⁹⁹** EA



Rawlings

TWO-TONE CATCHER'S HELMET

- Meets revised NOCSAE standards
- Meets all NFHS requirements
- Sleek two-toned design and fit
- Clearview wire design for optimum visibility
- Multiple air vents
- Adjustable back plate

Color Options: **Black, Royal, Scarlet.**

1383965 Varsity (7 1/8 - 7 3/4) **\$129⁹⁹** EA
1383968 Youth (6 1/2 - 7) **\$104⁹⁹** EA



MacGregor CHEST PROTECTORS

All available in **BLACK ROYAL SCARLET**



MCB75 JUNIOR CHEST PROTECTOR

1298345 Ages 5 to 8 \$56⁹⁹ EA ★



MCB74 YOUTH CHEST PROTECTOR

1298376 Ages 9 to 12 \$62⁹⁹ EA ★



MCB73 PREP CHEST PROTECTOR

1298406 Ages 13 to 15 \$74⁹⁹ EA ★



MCB70 PRO CHEST PROTECTOR

1298437 Ages 15+ \$79⁹⁹ EA ★



MCB80/81 FEMALE CHEST PROTECTORS

1298475 Varsity \$69⁹⁹ EA ★
1298505 Youth \$59⁹⁹ EA ★

MacGregor LEG GUARDS

All available in **BLACK ROYAL SCARLET**

DOUBLE KNEE



SINGLE KNEE



B62 JUNIOR SINGLE KNEE

- 9" shin plate
- Protection area of 18"
- Black only

1159318 Ages 5-8 \$59⁹⁹ PR ★

B66 PREP DOUBLE KNEE

- 11" shin plate
- Full-wing ankle protectors
- Protection area of 25"

1159400 Ages 12-15 \$79⁹⁹ PR ★

B68 JUNIOR DOUBLE KNEE

- 9" shin plate
- Protection area of 20"

1159431 Ages 5-8 \$74⁹⁹ PR ★

B61 VARSITY DOUBLE KNEE

- 12" Shin plate
- Full ankle and calf wing

1159288 Ages 15+ \$109⁹⁹ PR ★

B64 YOUTH DOUBLE KNEE

- 10" shin plate.
- Protection area of 23".

1159349 Ages 9-12 \$74⁹⁹ PR ★

LEG GUARD REPLACEMENT STRAPS

Replacement straps for catcher's leg guards. Black only.

1012187 Black only \$34⁹⁹ DZN ★



CATCHER'S KNEE SUPPORT

- Supports and cushions the knee, minimizing the stress on the knee in the catcher's position
- Attach to the leg guard straps
- Black only

1184747 Adult Size \$34⁹⁹ PR ★
1184754 Youth Size \$34⁹⁹ PR ★



\$199⁹⁹

GIRL'S FAST PITCH CATCHER'S GEAR PACK

- Package Includes:
- Adjustable catcher's combo helmet
 - MCB81 girls chest protector
 - Youth double knee leg guards
 - 4" throat protector

1186956 Ages 9-13 \$199⁹⁹ PACK ★



\$289⁹⁹

VARSITY FAST PITCH CATCHER'S GEAR PACK

- Package includes:
- Pro style varsity catcher's helmet
 - MCB80 varsity female chest protector
 - Prep double knee leg guards
 - 4" throat protector

1186925 Ages 14+ \$289⁹⁹ PACK ★



BLACK MAGIC 2.0 BOX SET

- Includes: Black Magic 2.0 helmet, chest protector and leg guards
- Hockey style helmet design
- Available in black ONLY

EAA165444 Youth (9-12) \$189⁹⁹ EA
EAA165445 Junior Youth (6-8) \$189⁹⁹ EA

MacGregor UMPIRE EQUIPMENT



UMPIRE ACCESSORY PACK

- Boxed set includes:
- Plate brush (MCB91XXX)
 - Ball bag (balls not included)
 - 4-way indicator

MCUMPKIT	Complete Pack	\$29 ⁹⁹ PACK ★
MCB94XXX	Bag Only	\$23 ⁹⁹ EA ★
MCB91XXX	Plate Brush Only	\$18 ⁹⁹ EA ★



COMPLETE UMPIRE PACK

- Box Set includes:
- B29 Pro 100 mask (MCB29BXX)
 - MCB79 inside chest protector
 - MCB67 leg guards
 - Ball bag (balls not included)
 - Plate brush
 - 4-way indicator (BBUMPIN4)

MCUMPSET \$249⁹⁹ PACK ★

MacGregor MCB29 PRO MASK

- Hollow tubular steel frame
 - Lighter than traditional masks
 - Durable vinyl coating with extended ear and throat guard
 - Complete with harness
- Color Options: **Black.**



MCB29BXX With Black Vinyl Pads \$144⁹⁹ EA ★



MCB78 OUTSIDE CHEST PROTECTOR

- Filled with 3" thick lightweight foam
- Adjustable shoulder straps with vinyl neck rest
- Features a built in ball pocket

MCB78BXX Size: 21 1/2"L \$109⁹⁹ EA ★



MCB79 INSIDE CHEST PROTECTOR

- Super light weight
- Wrap-around throat pad
- Extended upper shoulder ribs

MCB79BXX Size: 16.5"L \$99⁹⁹ EA ★



PRO UMPIRE SHIRT

- 100% polyester
 - Reinforced front pocket
 - Rib knit collar and cuffs
- Size: **MED, LRG, XLG.**

CUMPRO	Navy - MD-XL	\$45 ⁹⁹ EA ★
CUMPROXX	Navy - XXL	\$39 ⁹⁹ EA ★
CUMPROXXX	Navy - XXXL	\$41 ⁹⁹ EA ★
LBUMP	Lt Blue - MD-XL	\$41 ⁹⁹ EA ★
LBUMPXXL	Lt Blue - XXL	\$39 ⁹⁹ EA ★
LBUMPXXX	Lt Blue - XXXL	\$41 ⁹⁹ EA ★



ALL-STAR® PRO INTERNAL SHELL CHEST PROTECTOR

- Hardened HDPE plates for a clean low profile look
- Moldable plates in collarbone for protection and custom fit
- Matte black fabric

1459355

13"

\$125⁰⁰ EA



MacGregor MCB67 UMPIRE'S LEG GUARDS

- Molded ABS construction
- Durable close-cell foam
- Fully padded ankle and instep
- 12" shin plate

MCB67XXX Black only \$74⁹⁹ PR ★



MacGregor UMP'S INDICATOR

- Records balls, strikes, outs

BBUMPIND	Plastic	\$10 ⁹⁹ EA ★
BBUMPSTL	Steel	\$10 ⁹⁹ EA ★

4 WAY UMPIRES INDICATOR

- Plastic indicator
- Records balls, strikes, outs and innings.

BBUMPIN4 \$9⁹⁹ EA ★



SHORT BILL UMPIRE CAP

- Polywool umpires cap with 1-1/2" short bill
- Adjustable hook/loop back
- Navy only

BBUCSBNV Fits Sizes 6 7/8" - 7 1/4" \$19⁹⁹ EA

ALL-STAR® PRO UMPIRE LEG GUARDS

- Available in 15", 17" and 19"
 - Lightweight, low profile design for extra protection
- Size: **15", 17", 19"**.

1459356

Specify Length

\$99⁹⁹ EA





12.5" VARSITY FIELDER'S GLOVE

- Pre-oiled leather construction
- Open web design
- Quick and easy break in
- Ideal for infield or outfield

MCFG125X Fits Left Hand \$74⁹⁹ EA ★
MCFG125R Fits Right Hand \$74⁹⁹ EA ★



13.5" FIELDER'S GLOVE

- Selected cowhide palm and back
- Leather lining and lacing
- Finger hole & adjustable strap
- Open web design

BBFSPROX Fits Left Hand \$86⁹⁹ EA ★
BBFSPROR Fits Right Hand \$86⁹⁹ EA ★



12.5" YOUTH FIELDER'S GLOVE

- Leather palm and webbing
- Synthetic backing
- Adjustable wrist strap
- Open web design

BBMESHXX Fits Left Hand \$54⁹⁹ EA ★
BBMESHXX Fits Right Hand \$54⁹⁹ EA ★



12" SCHOLASTIC FIELDER'S GLOVE

- Leather palm and webbing
- Synthetic backing
- Adjustable wrist strap
- Ideal for baseball and softball

BBBGVARX Fits Left Hand \$54⁹⁹ EA ★
BBBGVARR Fits Right Hand \$54⁹⁹ EA ★



33.5" VARSITY CATCHER'S MITT

- High grade pre-oiled leather
- Exclusive major league design
- Ideal for varsity to adult players

MCCM200X Fits Left Hand \$107⁹⁹ EA ★



32" YOUTH CATCHER'S MITT

- Full grain leather
- Pre-oiled for easy break in
- Deep pocket and scoop toe design
- Ideal for ages 9-12.

BBBCMPROX Fits Left Hand \$84⁹⁹ EA ★
BBBCMPROR Fits Right Hand \$84⁹⁹ EA ★



29" JUNIOR CATCHER'S MITT

- Full grain leather
- Pre-oiled for easy break in
- Deep pocket and scoop toe design
- Ideal for ages 5-8.

BBBCMLLXX Fits Left Hand \$74⁹⁹ EA ★
BBBCMLLFR Fits Right Hand \$74⁹⁹ EA ★



33" PREP CATCHER'S MITT

- Top quality pre-oiled leather
- Scoop toe design
- Deep grip pocket
- Ideal for ages 12-15

MCCM100X Brown - Fits Left Hand \$84⁹⁹ EA ★
MCCM101X Black - Fits Left Hand \$84⁹⁹ EA ★

FAST PITCH



34" FASTPITCH CATCHER'S MITT

- Pre-oiled full grain leather w/ rawhide lacing
- Pre-formed for easy break-in
- Large softball pattern with dual "H" post web design
- Exclusive PROLOCK hook-and-loop fastener wrist closure

MCCM300X Fits Left Hand \$112⁹⁹ EA ★

TEE BALL



10.5" TEE BALL GLOVE

- Soft synthetic leather construction for easy break in
- Rawhide lacing for added durability
- Adjustable wrist strap
- Ideal for t-ball and youth baseball.

BBFGTBXX Fits Left Hand \$39⁹⁹ EA ★
BBFGTBXX Fits Right Hand \$39⁹⁹ EA ★

FIRST BASE



12.5" 1ST BASE MITT

- All leather construction
- Pre-oiled for short break-in period
- Top quality first base mitt for youth through high school

MCFB100X Fits Left Hand \$87⁹⁹ EA ★
MCFB100R Fits Right Hand \$87⁹⁹ EA ★

**BEST
SELLER**



INFIELD TRAINING GLOVE

- "Pancake" style glove is ideal for infield training
- Aids in developing a quick "glove to throw" transition
- Leather construction

1281491 Fits on left hand \$49⁹⁹ EA ★



COLLEGIATE REBOUNDER SCREEN

- Large 7' x 7' frame
- Heavy-duty 1 1/2" square, 17 gauge galvanized steel tube construction
- 2.5mm twisted knotted PE, 1.75" mesh
- Rebounder has 4 angle adjustments - 0, 10, 20 and 30 degrees - and can direct ball up into the air or onto the ground
- Can be used from either side

1378661

\$539⁹⁹ EA ★



PRO MODEL

- Advanced tool lets coaches place grounders, flyballs, and line drives with pinpoint accuracy
- Made of graphite composites as professional rackets
- Treated torsion bands propel baseballs or softballs with speed and accuracy
- Perimeter weighted design
- Non-slip grip

BBACCBAT

26oz Pro Model

\$109⁹⁹ EA



THE ZONE: TRAINING HOME PLATE

- All-weather durable rubber construction with colored sections to promote pitcher, hitter, and umpire strike zone training
- Perfect training tool for baseball, softball and umpire at all levels
- For pitchers, learn to paint the corners with this hi-visibility concentrated pitching zone home plate
- For hitters, learn to see and understand the strike zone with the three designated highlights
- Sits on top of home plate
- Extended 28.5" x 17.5" option available

CPB024

\$32⁹⁹ EA

CPB024X

28.5" x 17.5" Extension

\$49⁹⁹ EA



THE DESIGNATED HITTER

- Learn to pitch inside and how to handle hitters who crowd the plate
- Two-piece for safe and easy portability.
- Available in jersey colors: Red, Blue and Gray.
- Pro model batter stands 5'9" tall.
- Youth model batter stands 5'2" tall.

1323498

Pro Model

\$459⁹⁹ EA

1323504

Youth Model

\$449⁹⁹ EA



EASTON

EASTON THUNDERSTICK T10/T11

- Ideal for soft toss drills
- Can be used with plastic or regular baseballs
- Use plastic golf ball to sharpen hand-eye coordination
- 1" barrel

1264005

Adult T10 (33"/37oz)

\$89⁹⁹ EA

1264012

Youth T11 (30"/26oz)

\$84⁹⁹ EA

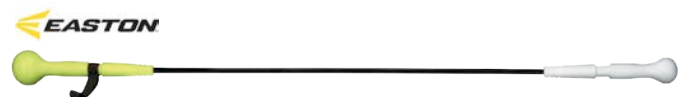

EASTON

EASTON TRAINING STICK

- The most effective & versatile batting drill device available
- Unique design features **BOTH Baseball & Softball ends**
- 63" length ideal for both Adult & Youth players
- Flexible shaft, texturized vibration dampening handle
- Dramatically improves hitting stance, contact and bat control

1264050

\$89⁹⁹ EA

BSN SPORTS



BASEBALL/SOFTBALL SCOREBOOK

- Ideal for baseball or softball with spiral at the top
- Each book scores 24 games with 16 batting positions and 9 innings per sheet
- Also includes team roster, season schedule, season totals, batting average chart, pitcher stats and simplified scoring instructions
- Pages measure 9-1/2" x 11"

MSBASBOK Standard Size \$13⁹⁹ EA

BASEBALL/SOFTBALL SCOREBOOK OVERSIZED

- Oversize pages (14" x 11") pages for easier scoring
- 30 game scorebook with 11 batting positions
- Also includes team roster, season schedule, season totals, batting average chart, pitch count, and simplified scoring instructions.

MCBIGBOK \$22⁹⁹ EA

BASEBALL/SOFTBALL LINE-UP CARD BOOKLET

- Four-part carbonless line-up cards
- 24 sets per booklet.
- 4 1/2" x 8 1/2"

MCLINEUP \$12⁹⁹ EA

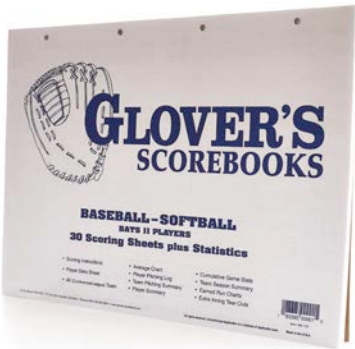

GLOVER'S BASEBALL/SOFTBALL SCORING & STAT REFILLS

- Includes simplified scoring instructions, batting average chart, 6-7-9 inning ERA chart, team summary pages, individual batting and pitching charts, and inning extenders.
- Sheets are 11" x 14.5"

MSGSCST pack of 30 \$24⁹⁹ PACK

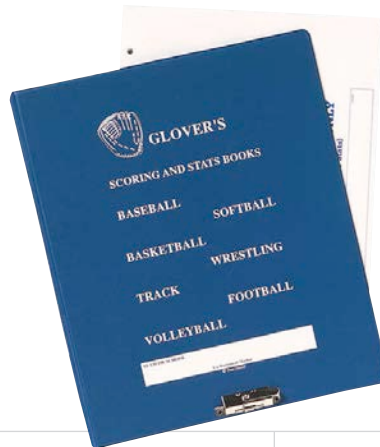

GLOVER'S BINDER

- Keep 24, 48, or 72 games in one binder
- Clip keeps scoresheets firmly in place
- Multiple pockets for schedules, addresses, player rosters, etc
- Scoresheets not included.

MSGLBIND \$35⁹⁹ EA



PETERSON® SCOREMASTER

- Simplified scoring instructions
- Wire binding
- Club size 12" x 8-1/2"
- Enables complete summary of individual batting records and pitching performance
- Suitable for softball as well as baseball
- Contains 25 games with 11 batting positions.

MSPTRBOK \$19⁹⁹ EA

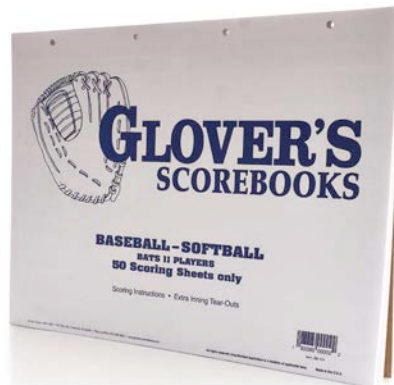

GLOVER'S BASEBALL/SOFTBALL SCORE SHEETS

- Includes inning extenders
- Packaged for coaches who have a computer and do not need individual stat sheets
- 11 batting positions

MSGLSCOR pack of 50 \$29⁹⁹ PACK



BASEBALL COACH'S BOARD

- Front player line up and back baseball field writing surfaces
- Includes premium dry erase marker
- 8"W x 15 1/2"L

1388108 \$29⁹⁹ EA ★



MLB® POLY TEE

NKN223
NKNY23

Adult S-3XL
Youth S-XL

\$29⁹⁹ EA
\$24⁹⁹ EA



MLB® COTTON TEE

NKN199
NKNY28

Adult S-3XL
Youth S-XL

\$22⁹⁹ EA
\$17⁹⁹ EA





MAJOR LEAGUE® REPLICA CAPS BY OUTDOOR CAP

- Features 3D logo, performance material construction & adjustable tab back

MLB350Y	Youth(6 5/8-7 1/4)	\$11.99 EA
MLB350A	Adult(6 7/8-7 1/2)	\$11.99 EA



MAJOR LEAGUE® REPLICA VISORS BY OUTDOOR CAP

- Performance material construction
- Adjustable tab back
- One size fits all

MLB185	\$11.99 EA
--------	------------



MLB® 1-BUTTON JERSEY

NKN383	Adult S-3XL	\$32.99 EA
NKNY83	Youth S-XL	\$29.99 EA



GAME BALLS



NFHS
APPROVED

MacGregor
X6000

- Durable composite construction, wide-channel
- Indoor/Outdoor use

MCX6000X	Official Size (29.5")	\$36⁹⁹ EA ★
MCX6285X	Intermediate Size (28.5")	\$36⁹⁹ EA ★
MCX6275X	Junior Size (27.5")	\$36⁹⁹ EA ★



MacGregor

X100

- Microfiber composite, wide-channel
- Indoor use only

MCX100XH	Official Size (29.5")	\$44⁹⁹ EA ★
MCX128XH	Intermediate Size (28.5")	\$44⁹⁹ EA ★



ELITE ALL COURT 2.0

- Deep channels for precision control
- Competition-level composite for soft touch
- Indoor/Outdoor Use

NKN100413985507	Official Size (29.5")	\$39⁹⁹ EA
NKN100413985506	Intermediate Size (28.5")	\$39⁹⁹ EA
NKN100413985505	Junior Size (27.5")	\$39⁹⁹ EA



MacGregor

X6000SL

- Synthetic construction
- Wide channel design
- Indoor/Outdoor use

1297140	Official Size (29.5")	\$30⁹⁹ EA ★
1297157	Intermediate Size (28.5")	\$30⁹⁹ EA ★



Wilson
NCAA LEGEND

- Deeper rubber channels constructed for improved grip
- Soft-touch composite cover for quality feel
- Indoor/Outdoor use

WLWTB0923XDEF	Size 7 (29.5")	\$38⁹⁹ EA
WLWTB0924XDEF	Size 6 (28.5")	\$38⁹⁹ EA
WLWTB0925XDEF	Size 5 (27.5")	\$38⁹⁹ EA



SPALDING
EXCEL TF-500

- Performance composite cover
- Deep channel design for superior control
- Indoor/Outdoor use

1457064	Official Size (29.5")	\$42⁹⁹ EA
1457065	Intermediate Size (28.5")	\$42⁹⁹ EA
1457066	Junior Size (27.5")	\$42⁹⁹ EA

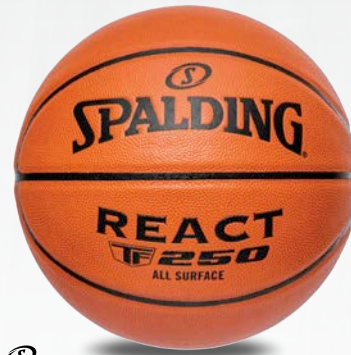

SPALDING
REACT TF-250

- All-surface composite leather cover
- Butyl rubber bladder for air retention
- Indoor/Outdoor use

1457067	Official Size (29.5")	\$32⁹⁹ EA
1457068	Intermediate Size (28.5")	\$32⁹⁹ EA
1457069	Junior Size (27.5")	\$32⁹⁹ EA



Wilson EVOLUTION

- Cushion Core carcass gives signature Evolution feel
- Microfiber composite cover for added grip & durability
- Laid-in channels are pebbled for added control
- Indoor use only

1013900	Size 7 (29.5")	\$79⁹⁹ EA
1013917	Size 6 (28.5")	\$79⁹⁹ EA



Wilson EVO NXT

- Extended Range Tech and pebbled channels
- Advanced moisture-wicking system
- High visibility electric orange color
- Indoor use only

WLWZ10033XB7	Size 7 (29.5")	\$99⁹⁹ EA
WLWZ10033XB6	Size 6 (28.5")	\$99⁹⁹ EA



SPALDING PRECISION TF-1000

- Deep channel design and composite cover
- Responsive cushioned sponge carcass
- Indoor use only

1457060	Official Size (29.5")	\$69⁹⁹ EA
1457061	Intermediate Size (28.5")	\$69⁹⁹ EA

1460975



SPALDING TF-1000 LEGACY

- Microfiber composite and responsive cushioned carcass
- Deep channel design for superior control
- Indoor use only

1457054	Official Size (29.5")	\$79⁹⁹ EA
1457055	Intermediate Size (28.5")	\$79⁹⁹ EA



Nike ELITE TOURNAMENT

- Extra-deep channels
- Durable design
- Composite exterior to help ensure grip
- Indoor use only

NKN100011485507	Official Size (29.5")	\$54⁹⁹ EA
NKN100011485506	Intermediate Size (28.5")	\$54⁹⁹ EA



Nike ELITE CHAMPIONSHIP 2.0

- Textured in-laid channels
- Premium soft touch composite
- Non Slip logos for consistent grip
- Indoor use only

NKN100408687807	Official Size (29.5")	\$74⁹⁹ EA
NKN100408687806	Intermediate Size (28.5")	\$74⁹⁹ EA



Baden ELITE PRO

- Advanced microfiber cover
- Perfect balance of tack and softness
- Cushion Control Technology
- Indoor use only

1460974	Official Size (29.5")	\$89⁹⁹ EA
1460975	Intermediate Size (28.5")	\$89⁹⁹ EA

THE ROCK®

COACH'S CHOICE

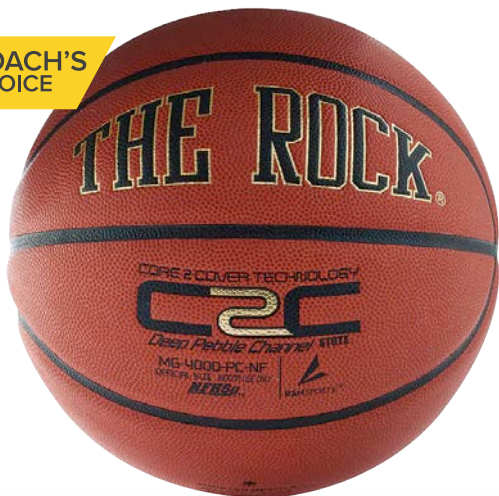

C2C COMPOSITE GAME BALL



- C2C Premium reinforced composite cover with sponge rubber carcass
- Double-ply Nylon wound bladder
- Deep Pebble channel design
- Indoor use only

1394967	Official Size (29.5")	\$54⁹⁹ EA
1394968	Intermediate Size (28.5)	\$54⁹⁹ EA

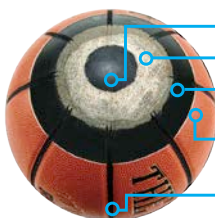

- Reinforced double ply Butyl Bladder -maximum air retention
- 100% Nylon wound -excellent shape retention and durability
- Exclusive patented sponge rubber carcass layer -extreme softness and handling improvement
- New Premium Grade Reinforced Composite material -Superior Durability. Scuff Resistant and NO Break-in Needed-Ready -Game Play!
- Unique Deep Pebble Channel design for best feel and grip



C2C CUSTOM GAME BALL

- C2C Premium reinforced composite cover with sponge rubber carcass
- Double-ply Nylon wound bladder
- Deep Pebble channel design
- NFHS Approved
- Great way to personalize your Game basketballs
- 60 ball order minimum. Sizes may be combined in increments of 12 to meet quantity requirements
- Only one logo location per 60 ball minimum allowed. 1 or 2 Color logo included
- Delivery Clock does not begin until order is complete and artwork is approved
- Please allow 3-5 business days for proof from the factory
- Delivery in 90 to 120 days after artwork approval
- Please call for more information

1394967FP	Official Size (29.5")	\$74⁹⁹ EA
1394968FP	Intermediate Size (28.5")	\$74⁹⁹ EA
1394977FP	Junior Size (27.5")	\$74⁹⁹ EA

CALL FOR QUANTITY PRICING.

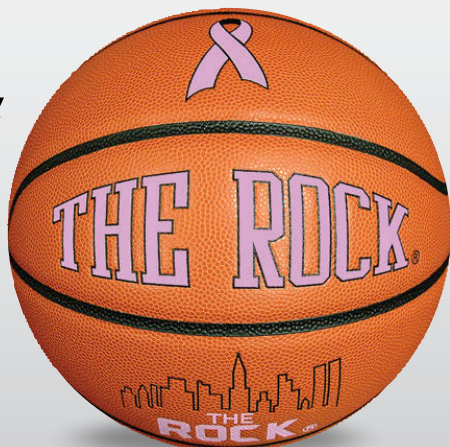

PINK RIBBON

- Same ball as the C2C composite game ball
- Includes Pink lettering and Pink Ribbon to recognize Cancer Awareness
- Double-ply Nylon wound bladder
- Deep Pebble channel design
- Indoor use only

1394971	Official Size (29.5")	\$52⁹⁹ EA
1394972	Intermediate (28.5")	\$52⁹⁹ EA

THE ROCK®



Limited colors available!

THE ROCK® RUBBER - COLORS

- Durable rubber cover
- Enhanced pebbling
- Wide channel design
- Indoor/Outdoor use

LD874MG4200
LD874MG4300LR

Official Size (29.5")
Intermediate Size (28.5")

\$13⁹⁹ EA
\$13⁹⁹ EA



THE ROCK® AUTOGRAPH BASKETBALL

- Top quality synthetic leather cover
- Great for awards and displays
- 6 White panels

1394976

Official Size (29.5")

\$44⁹⁹ EA



THE ROCK CUSTOM RUBBER BASKETBALL

- Minimum quantity of 108(Off,Inter) 100(Jr) per size. Sizes cannot be mixed to meet minimums. Must be ordered in increments of 36(Off,Inter) 50(Jr)
- Delivery Clock does not begin until order is complete and artwork is approved
- Please allow 3-5 business days for proof from the factory
- Delivery time 120 - 150 days from artwork approval
- Please call for more information

1394981FP
1394982FP
1394983FP

Official Size (29.5")
Intermediate Size (28.5")
Junior Size (27.5")

\$19⁹⁹ EA
\$19⁹⁹ EA
\$19⁹⁹ EA

CALL FOR QUANTITY PRICING.



HOT SHOT BASKETBALL SHOOTING MACHINE

TAKING TRAINING TO THE NEXT LEVEL

- Colorlok Precision-Guided Technology that locks onto the shooter's color of jersey
- Automatically tracks the shooter's every move, every change in direction and every change in speed
- Delivers a Game-Like pass with realistic backspin and velocity
- Multiple Shooters and programmed drills that works any spot on the floor
- Shoot off the dribble or shoot off the catch
- Full-Speed workouts with more reps
- Electronic controls with multiple speeds and selectable shot delay
- Quiet operation; Counts number of shots made
- Light weight, easy setup and take down with one person in just a couple of minutes
- Decals available at no additional cost
- Lifetime limited warranty

1399645

625 lbs.

\$10,999⁹⁹ EA

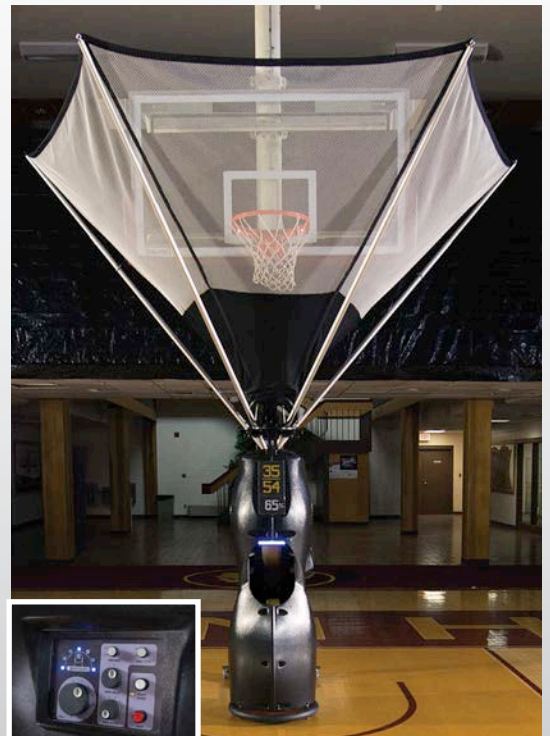

INDOOR/OUTDOOR BALLS



MacGregor RECRUIT

- High pebble rubber construction
- 22" circumference for younger players
- Indoor/Outdoor use

MCMINIBB Mini Size (22") \$14.99 EA ★



SPALDING ROOKIE GEAR

- High performance composite construction
- Specifically engineered for kids ages 8 and under
- 27.5" - weighs 25% less than a standard ball
- Indoor/Outdoor use

1273281 Multi-Color \$32.99 EA
1273274 Brown \$32.99 EA



AUTOGRAPH BASKETBALL

- Laminated synthetic leather (PVC) cover
- For display purposes only
- 4 White panels
- Official Size (29.5")

1072501 Official Size (29.5") \$42.99 EA ★



Voit

LITE 80

- Rubber construction
- 20% lighter than a standard junior sized ball
- Indoor/Outdoor use

1291735 Junior - 27.5" \$19.99 EA ★



Voit

LITE 80 PRISM PACK

- Set includes 1 each: Blue, Green, Orange, Purple, Red and Yellow
- Rubber construction
- 20% lighter than a standard ball
- Indoor/Outdoor use

1307030 Intermediate Size (28.5") \$99.99 SET OF 6 ★
1307047 Junior Size (27.5") \$99.99 SET OF 6 ★



MacGregor BUILDER HEAVY BALL

- Heavy duty rubber construction
- Over 2 times heavier than a regulation ball
- Increase arm, wrist and finger strength
- Improves dribbling, passing and shooting
- Indoor/Outdoor use

MCXHVME Official Size (29.5"), 3.0 lbs. \$44.99 EA ★
MCXHVWOM Inter Size (28.5"), 2.5 lbs. \$44.99 EA ★



SPALDING TF-TRAINER WEIGHTED

- Weight: 3 lbs.
- Extends shooting range
- Improves arm, wrist and finger strength
- Indoor use only

1459593 Official Size (29.5") \$69.99 EA
1459594 Intermediate Size (28.5") \$69.99 EA



SPALDING TF-TRAINER OVERSIZED

- Exclusive composite construction
- Improves shooting accuracy
- Indoor use only

1459595 33" \$79.99 EA

Voit RUBBER BASKETBALLS

ENDURO

- Durable rubber construction
- Recreational play
- Indoor/outdoor use

2 Year Limited Warranty

VCB2HXXX	Official Size (29.5")	\$17 ⁹⁹ EA ★
VCB8HXXX	Intermediate Size (28.5")	\$17 ⁹⁹ EA ★
VCB6HXXX	Junior Size (27.5")	\$17 ⁹⁹ EA ★
VCB5HXXX	Rookie Size (25.5")	\$17 ⁹⁹ EA ★



MacGregor RUBBER BASKETBALLS

RUBBER BASKETBALLS

- Durable rubber construction
- Wide channel design
- Indoor/Outdoor use

2 Year Limited Warranty

MCX35WID	Official Size (29.5")	\$19 ⁹⁹ EA ★
MCX500XX	Intermediate Size (28.5")	\$19 ⁹⁹ EA ★
MCX2500X	Junior Size (27.5")	\$19 ⁹⁹ EA ★



Voit

ENDURO CB2 REC DEPT. BASKETBALL

- Features "Property of Rec. Dept." logo
- Durable rubber construction
- Indoor/Outdoor use

2 Year Limited Warranty

VCB2HREC

Official Size (29.5")

\$17⁹⁹ EA ★

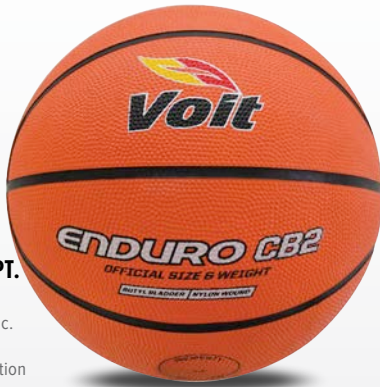

Voit

XB 20 THE GRIP

- 2 ply cushioned cover provides superior feel
- Super tack finish for increased ball control
- Indoor/Outdoor use

2 Year Limited Warranty

VXB20HXX
1235548
1235555

Official
Intermediate
Junior

\$21⁹⁹ EA ★
\$21⁹⁹ EA ★
\$21⁹⁹ EA ★



MacGregor

RUBBER BASKETBALL WITH YMCA LOGO

- Printed with YMCA logo
- Durable rubber construction
- Indoor/Outdoor use

2 Year Limited Warranty

1334098
1334104
1334111

Official Size (29.5")
Intermediate Size (28.5")
Junior Size (27.5")

\$18⁹⁹ EA ★
\$18⁹⁹ EA ★
\$18⁹⁹ EA ★



BSN SPORTS

COMPOSITE BASKETBALL WITH YMCA LOGO

- Composite leather ball printed with the YMCA logo
- Wide channel with a tacky grip
- Indoor/Outdoor use

1384322
1384323
1384324

Official Size (29.5")
Intermediate Size (28.5")
Junior Size (27.5")

\$29⁹⁹ EA ★
\$29⁹⁹ EA ★
\$29⁹⁹ EA ★



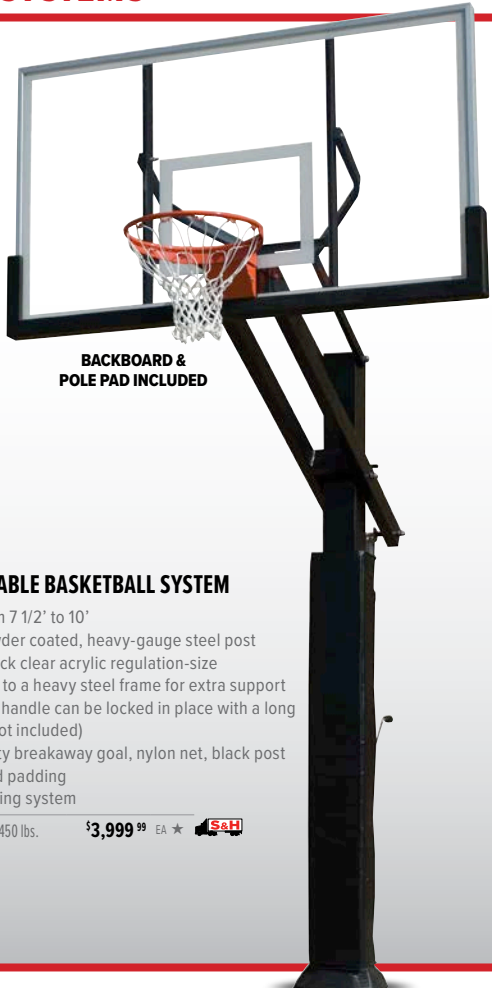

BACKBOARD & POLE PAD INCLUDED



GRIZZLY ADJUSTABLE BASKETBALL SYSTEM

- Height adjusts from 7 1/2' to 10'
- 6" x 6" square powder coated, heavy-gauge steel post
- 42" x 72" x 3/8" thick clear acrylic regulation-size backboard welded to a heavy steel frame for extra support
- Height adjustment handle can be locked in place with a long shackle padlock (not included)
- Includes heavy-duty breakaway goal, nylon net, black post pad and backboard padding
- Uses J-bolt anchoring system

1291247 450 lbs. **\$3,999⁹⁹** EA ★



ULTIMATE JR. SYSTEM

- 5" x 5" square powdered coated steel pole
- 5" x 5" square extension arm places backboard 36" away from pole
- Aluminum fan backboard w/breakaway goal - 35 1/2"H x 54"W
- Steel rectangular backboard w/flex goal - 42"H x 60"W

1388087 Fan Aluminum **\$3,399⁹⁹** EA
1388088 Rectangular Steel **\$3,499⁹⁹** EA



ULTIMATE™ OUTDOOR GLASS SYSTEM

- Same features as Ultimate system (871444XX) but with full size 42" x 72" competition glass backboard, heavy-duty flex goal, nylon net, post pad and backboard padding
- Lifetime guarantee on pole, five year limited guarantee on backboard, one year limited guarantee on goal and padding

Lifetime Warranty

987344XX 600 lbs. **\$7,249⁹⁹** EA



ULTIMATE™ POLE PADDING

- Protect players from injury caused by contact with pole
- 1" thick and 74" high vinyl covered foam
- Velcro attachment straps

870444XX Black only **\$1,299⁹⁹** EA



ULTIMATE™ FIXED HEIGHT SYSTEM

- 6" x 6" square powder coated, heavy-gauge steel post
- 42" x 60", 12 gauge steel, white powder coated backboard with graffiti-resistant finish and safety rolled edges to eliminate sharp contact points
- 60" safe play area
- Includes 5/8" double ring, ultimate playground goal with exclusive no-fail netlock system and nylon net (post pad not included)

Lifetime Warranty

871444XX 500 lbs. **\$4,499⁹⁹** EA



ULTIMATE HANGTIME ADJUSTABLE SYSTEM

- Heavy duty right angle crank can be locked to avoid unauthorized height adjustment with optional BALOCKHT HangTime rim height locking device
- 6" square heavy wall steel poles and unbreakable clear polycarbonate or tempered glass backboards
- All HangTime adjustable systems come standard with outdoor breakaway goal

Size: **42x60 Glass, 42x60 Poly, 42x60 Steel, 42x72 Glass, 42x72 Poly, 42x72 Steel.**

1460983 Specify Size **\$3,599⁹⁹** EA



OUTDOOR VERTICAL SYSTEM

- Built to withstand the use of your outdoor playground
- Available with 4' safe play area with with either 4 1/2" or 3 1/2" O.D. vertical galvanized steel pole
- Cast aluminum fan-shaped backboard with continuous reinforcing ribs
- White powder coated 54" x 39" board with shooters target
- Includes durable economy goal with nylon net
- Goal mount centers 5" x 5"

Limited Lifetime Warranty

PR50047A 4' Extension w/Economy Rim - 4 1/2" Post \$3,199⁹⁹ EA



OUTDOOR GOOSENECK SYSTEM

- These units are built to withstand the heavy duty use of your outdoor playground
- The goal, backboard and one-piece post bolt together forming a single solid unit
- Available with 4' safe play area with 4.5" O.D. galvanized steel gooseneck pole or 5' safe play area with 4.5" O.D. galvanized steel gooseneck pole
- Cast fan-shaped aluminum backboard with continuous reinforcing ribs
- White powder coated 54" x 39" board with shooters target
- Choose from 3 rim options: Double rim with Chain Net, Standard rim with Nylon net or Breakaway Goal with Nylon Net
- Goal mount centers 5" x 5" Limited Lifetime Warranty

PR50059	5' Extension w/Double Rim & Chain Net	\$2,299 ⁹⁹ EA	
PR50058	4' Extension w/Double Rim & Chain Net	\$2,099 ⁹⁹ EA	
PR50055	5' Extension w/Standard Rim & Nylon Net	\$2,299 ⁹⁹ EA	
PR50054	4' Extension w/Standard Rim & Nylon Net	\$2,199 ⁹⁹ EA	
PR50057	5' Extension w/Breakaway Rim & Nylon Net	\$2,299 ⁹⁹ EA	
PR50056	4' Extension w/Breakaway Rim & Nylon Net	\$2,199 ⁹⁹ EA	



MEGA DUTY BASKETBALL UNITS

- 5 9/16" O.D. galvanized steel pole
- 72" safe play area
- Goal mounts directly through backboard to pole to virtually eliminate stress on backboard when hanging occurs
- Heavy 1 5/8" backboard braces
- 48" in-ground bury
- System includes ultimate double rim, nylon net, backboard, backboard braces and post

Lifetime Warranty

1. 20020077	Steel Rectangular Backboard - 42" x 60"	\$5,299 ⁹⁹ EA	
2. 20020075	Aluminum Fan Backboard - 35" x 54"	\$4,299 ⁹⁹ EA	
3. 20020078	Polycarbonate Backboard - 42" x 54"	\$5,999 ⁹⁹ EA	



ALUMINUM FAN BACKBOARD

- Cast aluminum fan-shaped backboard with continuous reinforcing ribs
- White powder coated 54" x 39" board with shooters target
- Front mount Economy Goal with nylon net
- Standard 20" x 35" backboard mounting
- Universal goal mounting pattern
- Hardware included when purchasing board and goal together

Lifetime Warranty

PR232202	Backboard w/Super Goal and Nylon Net	\$1,299 ⁹⁹ EA	
PR232A	Backboard Only	\$1,199 ⁹⁹ EA	



1135 SHOWN HERE

porter

1135 COMPETITION PORTABLE

- Spring assisted, folding portable basketball system with non-marking caster wheels
- Equipped with a Center Strut glass backboard, pro pad backboard pad, Torq Flex Competition goal, and anti whip net
- Choose from a full-range of pad colors and frame colors
- Adjustable to 8', 9', and 10' heights

PR1135080C		\$20,399 ⁹⁹ EA	
PR1135080CSP	INCLUDES GRAPHICS	\$20,969 ⁹⁹ EA	

735 COMPETITION PORTABLE (image not shown)

- Center strut glass backboard with direct goal mount system
- Includes center strut glass board, Pro Pad backboard pad, Ultra Breakaway Competition goal, and anti whip net
- Spring assisted manual adjustment
- Available in 5' extension and adjusts to 8', 9', and 10' goal heights

PR735050C		\$16,899 ⁹⁹ EA	
PR735050CSP	INCLUDES GRAPHICS	\$17,429 ⁹⁹ EA	



MICRO-Z54 PORTABLE BASKETBALL STANDARD

- Highly portable system with 4" boom
- Rolls easily on four casters and locks in place with a brake lever
- Spring assisted height adjustment from 7' to 10'
- Black padded front base and riser
- Backboard padding not included
- Includes a 32" x 54" acrylic backboard and an official size breakaway goal with nylon net
- Requires 250 lbs. of ballast (not included)
- Not for main court use or dunking activities

2 Year Limited Warranty

1393447	Complete Unit	\$4,499 ⁹⁹ EA	
1393448	Replacement Backboard	\$899 ⁹⁹ EA	
1393449	Replacement Breakaway Goal	\$249 ⁹⁹ EA	



T-REX™ ADJUSTABLE/PORTABLE SYSTEMS

- Design makes one person setup and storage easy and fast
- Utilizes the same spring technology used in collegiate and professional arenas throughout the country
- Direct mount 42" x 72" glass backboard
- TruFlex Competition Breakaway Goal
- Adjustable from 5' to 10' (6" increments)
- Self-lubricating bronze bearings used in all pivot points
- Fully padded base (2" thick - covers 78" high)
- Duraskin™ backboard padding

895444XX	T-Rex 66 System	\$13,499 ⁹⁹ EA	
20026189	T-Rex 96 System	\$14,999 ⁹⁹ EA	



CLUB COURT PORTABLE BASKETBALL SYSTEMS

- 36" x 54" tempered glass backboard with break-a-way goal
- Spring assisted goal height adjustment from 6 1/2' to 10' with goal height indicator labels
- 1 1/2" thick, black padded front base and riser
- Oversized ballast box holds either 425 lbs. or 850 lbs. of ballast (not included)
- Goal mounts directly to extension arm, eliminating stress on backboard during play
- Folds without tools for transport on non-marking casters (fits through 78" high double doors)

2 Year Limited Warranty

1299373	Super Club Court	\$6,499 ⁹⁹ EA	
---------	------------------	--------------------------	--

ACRYLIC CLUB COURT

- 32" x 48" acrylic backboard
- Flex goal
- 36" safe play area when goal is at 10'
- Requires 425 lbs. of ballast (not included)

833444XX		\$4,699 ⁹⁹ EA	
----------	--	--------------------------	--



QWIKCHANGE™ SHOOTING STATION

- Entire system mounts easily to the wall with two load spreading struts
- No ladders or tools
- 7 1/2' to 10' goal height adjusts from the playing surface in 6" increments
- Mounts indoors/outdoors
- 22" safe play area at 10'
- Wall mounting hardware not included

20020250	1) Fan Shaped Graphite 36" x 48"	\$1,599⁹⁹ EA	S&H
1187687	2) Rectangular Acrylic 32" x 48"	\$1,999⁹⁹ EA	S&H



GYMNASIUM™ HEIGHT ADJUSTMENT SYSTEMS

- Adjusts rim height from 10' to 8' and anywhere between using hand crank operated from the floor
- Easy-to-read height indicator labels
- Heavy duty 2" square silver powder coated steel structure moves backboard 4 1/4" closer to the free throw line
- Most fan boards have 20" x 35" mounting
- Most 42" x 72" boards have 36" x 62" mounting
- Most 48" x 72" boards have 42" x 62" mounting

5043XXXX	20" x 35" Fan Mounting	\$2,649⁹⁹ EA	S&H
5042XXXX	36" x 62" Mounting	\$2,799⁹⁹ EA	S&H
5044XXXX	42" x 62" Mounting	\$2,899⁹⁹ EA	S&H



6-IN-1 EASY-UP™ YOUTH MINI GOAL

- Can be adjusted to 6 different heights (6 1/2' to 9')
- Lowers rim and moves rim 24" closer to free throw line; full sized rim
- Total system weight is less than 40 lbs.
- 32" x 48" backboard is molded of high impact ABS plastic
- Ships assembled and fits any style goal
- Not suitable for dunking or hanging from goal

1295825	\$1,449⁹⁹ EA
----------------	--------------------------------



ZIP CRANK™ ADJUSTABLE SHOOTING STATION

- 36" x 54" x 1/2" thick acrylic backboard looks and plays much like higher priced glass systems
- Easy to operate, removable hand crank adjusts goal height from 7 1/2' to 10'
- Competition design breakaway goal and direct goal mount design makes backboard virtually unbreakable during normal play
- Steel structure mounts to wall by means of three load spreading struts
- Mounts indoors/outdoors and has 30" safe play area at 10'
- Wall mounting hardware not included

20020300	\$3,349⁹⁹ EA	S&H
-----------------	--------------------------------	----------------



QWIKCHANGE™ PLAYGROUND SYSTEM

- Height adjusts from 7 1/2' to 10' (6" increments) without unbolting the backboard
- Includes 72" high black pole safety padding, reflex rim and net
- 34" base weighs 340 lbs. for stability
- Heavy duty 3 1/2" galvanized steel pole
- Base has (2) 3" heavy-duty wheels for easy transport
- Outdoor use only

20020801	Fan Shaped Graphite 36" x 48"	\$2,899⁹⁹ EA	S&H
20028011	Rectangular Acrylic 32" x 48"	\$3,149⁹⁹ EA	S&H



PLAYTIME™ BASKETBALL STANDARD

- Telescoping adjustment from 6'6" to 8' (6" increments)
- 34" white powder coated formed steel base
- Rubber rim protects the floor
- Goal, net, blue protective pad and hardware included
- Built-in 100 lb. ballast
- Indoor or outdoor use

20020803	\$2,499⁹⁹ EA	S&H
1271676	Replacement Backboard	\$449⁹⁹ EA

INDOOR/OUTDOOR BACKBOARDS



PRO-STRUT CONVERSION GLASS BACKBOARD

- 42" x 72" rectangular glass backboard
- Two vertical struts with fan shaped backboard mounting centers include all the necessary hardware
- Official white border and target area are fired into the glass
- Backboard padding is not included but is recommended for player safety.
- Goal sold separately

Lifetime Warranty

PR205A \$1,649⁹⁹ EA



ARG CONVERSION GLASS BACKBOARD

- 42" x 72" steel framed backboard only
- Replaces fan shaped or small glass backboards
- Designed for direct, three or four point mounting with steel mounting plates which strengthen backboard
- Frame pre-drilled for padding (not included)
- 5" x 4" goal mount pattern (goal sold separately)
- Meets NCAA and NFHS specifications

Lifetime Warranty

1237436 Backboard Only - 220 lbs. \$2,699⁹⁹ EA



CONVERSION GLASS BACKBOARDS

- Convert courts from fan-shaped to rectangular glass backboards
- Converts without a new mounting structure
- Ready to install with no drilling or relining of court
- Pre-drilled for DuraSkin® padding (not included)
- Mounting hardware included
- Goal sold separately

Lifetime Warranty

5155XXXX 42" x 72" - 223 lbs. \$1,749⁹⁹ EA
 5154XXXX 48" x 72" - 246 lbs. \$2,099⁹⁹ EA



STEEL REAR MOUNT BACKBOARD

- 35" x 54" backboard with 4" x 3 5/8" goal mounting pattern
- Standard 20" x 35" mounting
- Vibration-free unit stabilized by 12 gauge horizontal and 10 gauge vertical channels
- Phosphate treated and powder coated for maximum protection against weathering

1140118 Backboard with Goal and Net \$1,199⁹⁹ EA
 1140125 Backboard Only w/Target and Border \$949⁹⁹ EA
 1140132 Backboard Only - Solid White \$899⁹⁹ EA



STEEL FRONT MOUNT BACKBOARD

- 35" x 54" steel backboard with 5" x 4 1/2" goal mounting pattern
- Standard 20" x 35" mounting
- Phosphate treated and powder coated for maximum protection against weathering
- Goal sold separately

1140149 Includes Shooter's Square \$1,149⁹⁹ EA
 1140156 Solid White Backboard \$949⁹⁹ EA

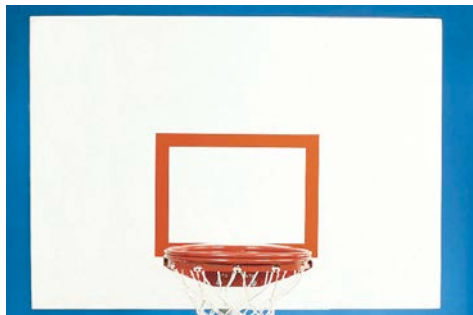

ULTIMATE STEEL BACKBOARD

- 42" x 60" backboard
- Graffiti resistant finish
- 5" X 5" goal mounting pattern
- 20" X 35" mounting brackets
- Attaches to any current fan-shaped ceiling or wall mounted structure

10 Year Limited Warranty

5156XXXX Backboard Only \$2,099⁹⁹ EA



FRONT MOUNT BACKBOARD

- 35 1/2" x 54" cast aluminum backboard
- White powder coated finish with orange shooters square
- Heavy support ribs
- Goal sold separately

Lifetime Warranty

1376346 Backboard Only \$1,099⁹⁹ EA



porter

CENTER STRUT GLASS BACKBOARD PACKAGE

- Official size backboard 42" x 72", goal mount centers 5" x 4.5"
- Three point support frame with direct goal mount (Center-Strut) support structure
- PR00208000 does not include backboard padding
- Package includes: 42" x 72" Center Strut Glas Backboard, Powr Flex Competition Goal, and Pro Pad backboard padding

5 Year Limited Warranty

PR20810C	Backboard Package	\$2,399 ⁹⁹ SET	
PR00208000	Backboard Only	\$1,699 ⁹⁹ EA	



porter

PRO STRUT GLASS BACKBOARD PACKAGE

- Official size backboard 42" x 72"
- Vertical Center-Strut goal support and four corner attachment support frame
- Allows installation on wall-mount units and double drop overhead supported units
- PR00204000 does not include backboard padding
- Package Includes: 42" x 72" Pro Strut Glass Backboard, Powr Flex Competition Goal and Pro Pad board padding

5 Year Limited Warranty

PR20410C	Backboard Package	\$2,499 ⁹⁹ SET	
PR00204000	Backboard Only	\$1,799 ⁹⁹ EA	



SPALDING

SUPERGLASS[™] COLLEGIATE PACKAGE

- Includes 1/2" tempered glass center strut backboard, Slam Dunk goal with tube-tie net system, and bolt-on backboard padding
- 42" x 72" glass backboard
- 36" x 63" mounting bracket spacing
- Meets all NCAA, NFHS and FIBA specifications

Color Options: **Black, Forest Green, Gold, Grey, Kelly, Maroon, Navy, Orange, Purple, Royal, Scarlet.**

7 Year Limited Warranty

1048292	Backboard, Goal and Padding	\$2,999 ⁹⁹ PACK	
---------	-----------------------------	----------------------------	--



Pison

UNBREAKABLE[™] SHORT GLASS BACKBOARD

- 42" x 72" with 1/2" thick tempered glass
- Built-in goal leveling device
- 35 1/2" x 62" mounting bracket spacing and 5" x 4" goal mounting pattern
- Pre-drilled for Duraskin[™] padding
- Note: The glass itself is not unbreakable. Breakage in transit, during mounting, malicious acts, or deliberate attempts to damage are not covered under this guarantee.

Lifetime Warranty

5150XXXX	Backboard with Padding	\$2,399 ⁹⁹ EA	
5151XXXX	Backboard Only	\$1,999 ⁹⁹ EA	



Pison

UNBREAKABLE[™] TALL GLASS BACKBOARD

- 48" x 72" with 1/2" thick tempered glass
- Built-in goal leveling device
- 42" x 62" mounting bracket spacing and 5" x 5" goal mounting pattern
- Pre-drilled for Duraskin[™] padding (not included)
- Note: The glass itself is not unbreakable. Breakage in transit during mounting, malicious acts, or deliberate attempts to damage are not covered under this guarantee.

Lifetime Warranty

1302776	Backboard Only	\$1,999 ⁹⁹ EA	
---------	----------------	--------------------------	--



REGULATION SIZE ACRYLIC BACKBOARD

- Heavy duty 3/8" thick acrylic backboard
- Heavy duty welded and powdercoated steel tubular uni-frame with struts for added board support
- Regulation size 42" x 72"
- Standard 36" x 62" backboard mounting pattern
- 5" x 5" goal mounting pattern

2 Year Limited Warranty

1245943	Backboard Only	\$1,849 ⁹⁹ EA	
---------	----------------	--------------------------	--



AFRG - ALUMINUM FRAME GLASS BOARD

- Heavy duty corner brackets and direct to goal mounting allows for disbursement of stress along the extruded frame
- 1/2" tempered glass with fired-in target and border
- 5" x 4" goal mounting pattern
- Meets NCAA, NAIA & NFHS specifications

Lifetime Warranty

1091974	42" x 72" Backboard Only	\$1,599 ⁹⁹ EA	
1237429	48" x 72" Backboard Only	\$1,599 ⁹⁹ EA	



Pison

HIGH SCHOOL BACKBOARD PACKAGE

- 42" x 72" glass backboard
- TruFlex Breakaway rim
- DuraSkin padding - 16 color options

Color Options: **Black, Brown, Burnt Orange, Cardinal, Columbia Blue, Forest, Gold, Grey, Kelly, Maroon, Navy, Orange, Purple, Royal, Scarlet, Vegas Gold.**

Lifetime Warranty

1376347	Backboard, Goal and Padding	\$2,899 ⁹⁹ EA	
5028XXXX	42" x 72" Backboard Only	\$1,899 ⁹⁹ EA	
5027XXXX	48" x 72" Backboard Only	\$1,999 ⁹⁹ EA	



FRONT MOUNT ECONOMY GOAL

- Front mount, 5/8" solid steel, powder coated single rim
- 5/8" reinforcing bars
- Continuous no-tie net attachment
- 5" x 5" Goal Centers
- Includes nylon net and mounting hardware
- Indoor/Outdoor use

PR00235000 \$229⁹⁹ EA



MacGregor
GAME SERIES FLEX GOAL

- Competition level flex rim
- Tube-tie net attachment
- 5" x 5" goal mounting pattern
- Powder coated finish
- Includes Anti-whip net and mounting hardware
- Meets NCAA and NFHS specifications
- Indoor/Outdoor use

5 Year Limited Warranty
PR236H00 \$349⁹⁹ EA



FRONT MOUNT FLEX GOAL

- Front mount, 5/8" solid steel, powder coated single rim
- Flex design with 15 deflection-auto return
- Continuous no-tie net attachment
- Universal goal mounting pattern
- Includes net and mounting hardware
- Indoor/Outdoor use

5132XXXX \$489⁹⁹ EA



MacGregor
FRONT MOUNT DOUBLE RIM FLEX GOAL

- Double 5/8" solid steel, powder coated rim
- Flex design with 15 degree deflection auto return
- Universal goal mounting pattern
- Includes net and mounting hardware
- Indoor/Outdoor use

Lifetime Warranty
PR238H00 \$349⁹⁹ EA



SPALDING
ROUGHNECK GORILLA GOAL

- Front mount, 5/8" solid steel, powder coated single rim
- 5/8" reinforcing bars
- Continuous no-tie net attachment
- Universal mounting pattern
- Includes net and mounting hardware
- Indoor/Outdoor use

3213XXXX \$299⁹⁹ EA



porter
DOUBLE RIM PLAYGROUND GOAL

- 5/8" top ring, 1/2" bottom ring, powder coated solid steel
- Two rim support braces for strength
- Universal goal mounting pattern
- Includes net and mounting hardware
- Outdoor use

Lifetime Warranty
PR00202H00 Nylon Net \$249⁹⁹ EA
PR00202NET Chain Net \$259⁹⁹ EA



240 - DOUBLE RIM FRONT MOUNT SUPER GOAL

- Double rings (5/8" top ring, 1/2" bottom ring)
- Continuous no-tie net attachment
- 4" x 5" and 5" x 5" mounting patterns
- Includes net and mounting hardware
- Outdoor use

2 Year Limited Warranty
1237474 \$429⁹⁹ EA



66T - REAR MOUNT INSTITUTIONAL GOAL

- Rear mount, 5/8" solid steel, powder coated single rim
- No-tie net attachment
- 4" x 3 7/8" mounting pattern
- Includes net and mounting hardware
- Outdoor use

20015034 \$299⁹⁹ EA



POWR-FLEX GOAL

- NCAA Division 2/3 and NFHS Compliant
 - 5" x 4" to 5" x 4.5" Mount Pattern
 - Tube Tie Net Attachment
 - Indoor Use Only
- 5 Year Limited Warranty**

PR22302 \$899⁹⁹ EA



TORQ FLEX COMPETITION GOAL

- NCAA and NFHS Compliant
 - 5" x 4" to 5" x 4.5" Mount Pattern
 - Tube Tie Net Attachment
 - Indoor use only
- 5 Year Limited Warranty**

PR240180 \$699⁹⁹ EA



ULTRA-FLEX BREAKAWAY GOAL

- Breakaway Rim
 - 5" x 4" to 5" x 4.5" Mount Pattern
 - Includes Net & Mounting Hardware
 - Tube Tie Net Attachment
- 3 Year Limited Warranty**

1388578 \$499⁹⁹ EA



1000 SCHOLASTIC BREAKAWAY GOAL

- Front mount, 5/8" solid steel, powder coated single rim
- Unique stack spring construction for true rebound
- Continuous no-tie net attachment
- 4" x 5" goal mounting pattern
- Includes net and mounting hardware
- Meets NCAA, NFHS and NAIA specifications
- Indoor use only

2 Year Limited Warranty

1237443 \$349⁹⁹ EA



SLAMMER COMPETITION 180-GOAL

- Front mount, 5/8" solid steel, powder coated single rim
- Adjustable tension 180° side and front flex action
- Easy-glide net attachment system
- Universal mounting pattern
- Includes net and mounting hardware
- Meets NFHS specifications
- Indoor use only

2 Year Limited Warranty

1008210 \$599⁹⁹ EA
1388019 #2 Net Cable \$79⁹⁹ EA



SLAM DUNK PRO GOAL

- Front mount, 5/8" solid steel, powder coated single rim
- Top adjust positive lock release mechanism
- Easy glide #2 net attachment system
- Universal goal mounting pattern
- Includes net and mounting hardware
- Meets NBA, NCAA and NFHS specifications
- Indoor use only

7 Year Limited Warranty

1007923 \$499⁹⁹ EA
1388019 #2 Net Cable \$79⁹⁹ EA



COLLEGIATE 2000 BREAKAWAY GOAL

- Front mount, 5/8" solid steel, powder coated single rim
- Adjustable positive lock mechanism allows precise fly-back action
- Continuous no-tie net attachment
- 4" x 5" or 5" x 5" goal mounting pattern
- Includes net and mounting hardware
- Meets NCAA, NFHS and NAIA specifications
- Indoor use only

4 Year Limited Warranty

5038XXXX \$399⁹⁹ EA



PROTECH BREAKAWAY GOAL

- Front mount, 5/8" solid steel, powder coated single rim
- Traditional ball and socket positive lock mechanism
- Continuous no-tie net attachment
- 4" x 5" and 5" x 5" goal mounting patterns
- Includes net and mounting hardware
- Meets NCAA and NFHS specifications
- Indoor use only

3 Year Limited Warranty

354444XX \$469⁹⁹ EA



ELITE BREAKAWAY GOAL

- Front mount, 5/8" solid steel, powder coated single rim
- Low maintenance breakaway mechanism with padded cover-plate
- Six point lubrication system for smooth action
- Net hideaway attachment system
- 4" x 5" and 5" x 5" goal mounting patterns
- Includes net and mounting hardware
- Meets NCAA and NFHS specifications
- Indoor use only

5 Year Limited Warranty

5111XXXX \$569⁹⁹ EA



BRUTE

- 288 gram, 12 loop, braided nylon

SNBBN288Y \$12⁹⁹ EA ★

STANDARD DUTY

- 144 gram, 12 loop, braided nylon

SNBBN144Y \$7⁹⁹ EA ★

HEAVY DUTY ANTI-WHIP

- 145 gram, 12 loop, braided nylon

SNBBNWIPIY \$12⁹⁹ EA ★

TRADITIONAL

- 90 gram, 12 loop, braided nylon

SNBBN90XY \$6⁹⁹ EA ★



MOUNTS AND BRACKETS



ADJUSTO-BRACKET BASKETBALL GOAL MOUNT

- Simply attach the Adjusto-Bracket to any flat surface and slide your goal into place to create a basketball play area
- For use on brick, wood, block or tile
- Goal not included
- 8 1/2"H x 7"W - 2 lbs.

PBBASBRX \$179⁹⁹ EA

GOAL FOR ADJUSTO BRACKETS

- For use with single or double Adjusto-Bracket goal mounts

5004XXXX \$159⁹⁹ EA



PREMIUM STEEL PLAYGROUND NET

- Zinc plated chain is three-times heavier than typical chain nets
- All links are welded into closed loops to prevent separation when chains are stretched during play
- Includes heavy-duty S-hooks for attachment to any style rim

2 Year Limited Warranty
504444XX \$129⁹⁹ EA



STEEL CHAIN NO-TIE SUPER NET

- 12 loop, zinc plated galvanized steel provides protection from weather
- Includes heavy-duty "S" hooks for attachment to any style rim

SNBBSTLN \$59⁹⁹ EA



BRAIDED POLY NET

- 3mm, 12 loop, braided polyethylene
- 400% more durable than nylon
- Designed for outdoor use

SNBBNPBRY \$9⁹⁹ EA ★



WEB OUTDOOR NET

- Flat strap design improves outdoor durability while maintaining the feel of traditional nylon nets
- Triple-stitched with non-rotting nylon thread
- Includes heavy-duty S-hooks for attachment to any style rim

SNBBN505 \$49⁹⁹ EA ★



DOUBLE ADJUSTO-BRACKET GOAL MOUNT

- Allows 12" height adjustment on one bracket to accommodate different age/height requirements
- 17"H x 8 1/2"W - 4 lbs.

4997XXXX \$249⁹⁹ EA

BACKBOARD PADDING



SAF-GUARD CUSHION EDGE BACKBOARD PADDING

- Soft, durable backboard padding made from high density polyurethane foam with tough outer skin
- Fits most standard 72" wide glass or acrylic backboards
- Reinforced, pre-drilled bolt holes for easy installation (mounting hardware included)
- Meets NCAA and NFHS specifications
- Indoor use only

Color Options: **Black, Grey, Navy, Red, Royal Blue.**

BB72

Specify Color

\$329⁹⁹ EA ★



DURASKIN BACKBOARD SAFETY PADDING

- Fits every manufacturers' official 72" backboard but might require frame drilling on non-Bison backboards (will not work with Zip Crank)
- Reinforced, pre-drilled bolt holes for easy installation (mounting hardware included)
- Meets NCAA, FIBA and NFHS specifications
- Indoor use only
- Rectangular color options: **Black, Brown, Burnt Orange, Cardinal, Columbia Blue, Forest Green, Gold, Grey, Kelly Green, Maroon, Navy, Orange, Purple, Royal, Scarlet, Vegas Gold**

10 Year Limited Warranty

5054XXXX

For Rectangular Backboards

\$379⁹⁹ EA



PRO-MOLD BACKBOARD PADDING

- Soft, durable backboard padding made from high density polyurethane
- Fits most standard 72" wide glass or acrylic backboards
- Reinforced, pre-drilled holes for installation
- Mounting hardware included
- Meets NCAA, NBA & NFHS specifications
- Indoor use only

Color Options: **Black, Dark Green, Gold, Grey, Kelly, Maroon, Navy, Purple, Royal, Scarlet.**

1092000

Specify Color

\$349⁹⁹ EA



PRO BOLT-ON BACKBOARD PADDING

- Extremely durable molded padding which meets all NBA, NCAA, NFHS and FIBA requirements.
- Choose from 12 colors

3 Year Limited Warranty

Color Options: **Black, Dark Green, Grey, Kelly Green, Light Blue, Maroon, Navy, Orange, Purple, Red, Royal, Yellow Gold.**

1383915

Specify Color

\$369⁹⁹ EA



COACHES EQUIPMENT



MARK V BASKETBALL SCOREBOOK

- Includes 30 games, 15 player spots, 3-point scoring, team roster, season schedule, season summary, and simplified scoring instructions
- 8 1/2" x 11" spiral bound with hard cover

MSMARKBK \$25⁹⁹ EA



HI-SCORE BASKETBALL SCOREBOOK

- Includes 34 games, 20 players per roster, scoring by quarters or halves, and simplified scoring instructions with illustrated example
- 8.5" x 11" wire-O bound

1458091 \$14⁹⁹ EA



BASKETBALL SCOREBOOK

- Includes 30 games, 15 player spots, 3-point scoring, team roster, season schedule, season summary, and simplified scoring instructions
- 8 1/2" x 11" spiral bound with soft cover

MSBSKBOK \$16⁹⁹ EA



BASKETBALL COACH'S BOARD

- Front half court and back full court writing surfaces
- Includes premium dry erase marker
- 8"W x 15 1/2"L

1388107 \$29⁹⁹ EA ★

BASKETBALL PLAYMAKER DRY ERASE BOARDS

- Heavy duty aluminum framed magnetic 48" x 72" dry erase board
- 1 full court and 2 half courts (roll-a-way version has blank space on opposite side)
- Includes (4) dry erase pens, magnetic pieces with vinyl numbering system and an eraser

1298840 Roll-A-Way Version \$1,499⁹⁹ EA 
1366512 Wall Mount Version \$899⁹⁹ EA 

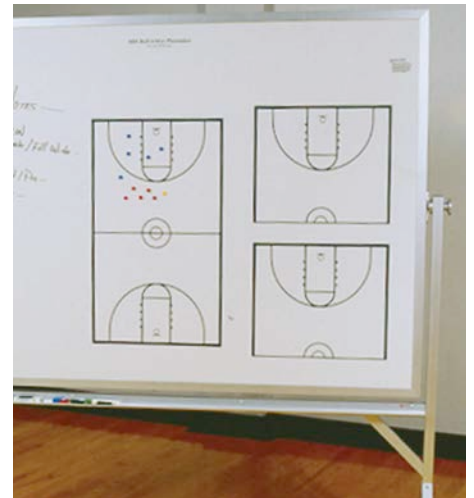

DRY ERASE BOARDS

- Large format enables entire team to see play
- 2 writing surfaces
- Great pen clip with premium dry erase marker
- 1/2 court featured on back
- 12 1/2"H x 16 1/2"W - 2 lbs.

1405765 12 1/2"H x 16 1/2"W - 2 lbs. \$39⁹⁹ EA



PORTABLE PLAYMAKER BASKETBALL BOARD

- 18" x 24" durable dry erase board with handle
- Full-court diagram on one side, the other side is a blank, dry erase surface that can be used to flash plays or other information from the sideline
- Includes dry erase pen that attaches to the board

1299786 \$84⁹⁹ EA

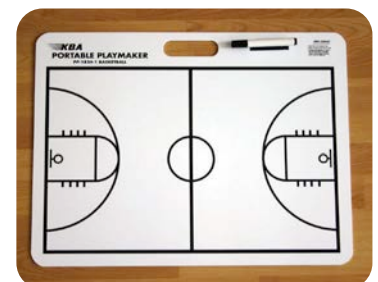

COURT EQUIPMENT

SLIPP-NOTT TRACTION SYSTEM-LARGE

- Used by professional, college, and high school basketball teams to remove dust, dirt and wax build-up from shoe soles with one quick action
- Simply walking on it improves the traction and maneuverability
- Large set: 28" x 29" base and (75) 26" x 26" sheets



1298697	Large Base & Pad Set	\$344⁹⁹ EA
1298703	Repl. Pad (75 sheets) for Large Set	\$139⁹⁹ EA

SLIPP-NOTT TRACTION SYSTEM-SMALL

- Used to remove dust, dirt and wax build-up from shoe soles
- Simply walking on it improves traction and maneuverability
- Typical game usage is 2-6 sheets
- 18" x 19" base and (75) 15" x 18" sheets



1298673	Small Base & Pad Set	\$199⁹⁹ EA
1298680	Repl. Pad (75 sheets) for Small Set	\$89⁹⁹ EA

COURTCLEAN START-UP/TUNE-UP KIT

- Keeps your floors clean and shiny
- Includes 5 gallon bucket, 4 towels and 1 gallon of Shine-All cleaner



1237566	Kit w/8' Towels	\$349⁹⁹ EA
1292015	Kit w/6' Towels	\$349⁹⁹ EA
1237573	1gal. Super Shine	\$79⁹⁹ EA

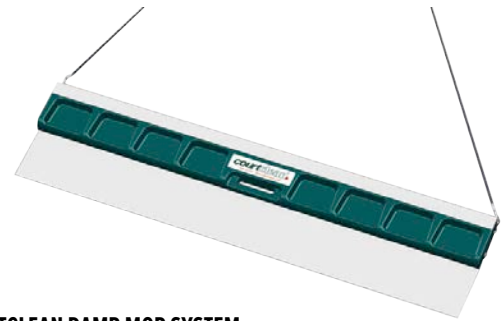

COURTCLEAN DAMP MOP SYSTEM

- Clean court in minutes
- Improves floor conditions and protects floor finish
- Includes custom sweeper pad, specially designed towel and pull rope
- Works on any hard floor surface

1271058	6' Unit	\$899⁹⁹ EA
1271065	6' Replacement Towel	\$64⁹⁹ EA
1079709	8' Replacement Towel	\$84⁹⁹ EA

H2O PERFORMANCE PACK

- Performance Pack includes 5 markers: red, orange, green, blue, and purple
- One canister of foot wipes
- One bag of R&R foot towels (20 towels)



1461860		\$84⁹⁹ PACK
----------------	--	-------------------------------

KEYCLEAN PRO

- Clean on the go...play like a pro!
- A large 18" x 24" surface offers full coverage for quick clean-up
- Highly absorbant, specially designed microfiber pads rapidly absorb sweat and moisture
- Reduces potential for slip and falls that can cause serious injury
- Custom Mops - Ships in 2 weeks to ship after art approval

1383869	Set of 2 Mops - Standard	\$499⁹⁹ EA
1399641	Set of 2 Mops w/Custom Logo	\$599⁹⁹ PACK
1393374	Microfiber Pad - Each	\$64⁹⁹ EA



FLOORMARX™ SET

- Safe, smart, and easy way to instruct movement
- Quick to apply and easy to remove
- Fast drying ink (2min) and cleaning wipes (30 sec) pass safety slip tests
- One Floor Marker writes for over 250 yards (over 4 rolls of traditional floor tape)
- Set includes 2 Floor markers, 1 green and 1 blue, and 1 canister cleaning foot wipes
- Intended for sealed gymnasiums and dance floors, and other non-porous surfaces
- BEFORE FULL APPLICATION, always test on multiple, small, inconspicuous areas of the floor



1454864		\$49⁹⁹ SET
----------------	--	------------------------------

FLOOR MARKING TAPE

- Use on any smooth floor surface
- Color Options: **Black, Blue, Green, Gold, Orange, Purple, Red, White.**

FTAP16	1" x 60 Yd.	\$11⁹⁹ EA ★
FTAP26	2" x 60 Yd.	\$16⁹⁹ EA ★



STORAGE EQUIPMENT



MONSTER BALL CART

- Fabricated from 1" square steel
- Black powder coated finish
- Holds 15 official size basketballs

7 Year Limited Warranty

1162608 30"H x 49"W x 20"D - 30 lbs. \$499⁹⁹ EA ★



TF 6-BALL BAG

- Internal compartments for 6 basketballs
- Adjustable and removable shoulder strap
- Open air side vents allow for moisture escape
- High grade durable construction

1459596 \$44⁹⁹ EA



DOUBLE MONSTER BALL CART

- Fabricated from 1" square steel
- Black powder coated finish
- Holds 30 official size basketballs

7 Year Limited Warranty

1162615 30"H x 49"W x 24"D - 54 lbs. \$699⁹⁹ EA ★



**3-ROW
12 BALLS**



15 BALL CART

- Heavy duty chrome steel rods
- Solid triangular frames for strength and stability
- Non-marring casters
- Wide base design prevents tip over
- Holds 15 official size basketballs

1159639 38"H x 51"W x 19"D - 10 lbs. \$184⁹⁹ EA ★



SUPER TUFF BALL CART WITH MASCOT

- Powder coated steel welded construction
- 3" non marring, swivel caster wheels
- Holds 15 official size basketballs
- Includes one-color school name or mascot
- Frame Colors: Royal, Red, Gray, White, Black, Athletic Gold, Orange, Forest Green, Kelly Green, Maroon, Navy, Columbia, Cardinal, Purple, Texas Orange

7 Year Limited Warranty

1366519 Size - 51"L x 20"W x 29"H \$649⁹⁹ EA



**4-ROW
16 BALLS**



HEAVY-DUTY BALL CARTS

- Welded 1" square wall tubing with 3/4" steel chrome plated, ball support arms
- Non-marring, high quality 360° swivel casters
- Extra wide wheel base avoids tipping
- Add a school or mascot name, up to (10) letters, to the end panels (lettering sold separately and is not applied by manufacturer)

5 Year Limited Warranty

Color Options: Grey, Royal Blue, Scarlet, White.

1048452	12 Ball Cart	\$649 ⁹⁹ EA
1048490	18 Ball Cart	\$699 ⁹⁹ EA
1245899	Lettering	\$129 ⁹⁹ EA

WIDE BODY BALL CARTS

- Heavy duty white powder coated steel tubing
- Non-marring, hard rubber casters with a wide, no-topple base
- Designed for easy storage and removal of balls
- 12 Ball Cart - 40"W x 40"H x 16"D
- 16 Ball Cart - 40"W x 52"H x 16"D

BCART12W	3 Row, 12 Balls	\$119 ⁹⁹ EA ★
BCART16W	4 Row, 16 Balls	\$149 ⁹⁹ EA ★



DOUBLE-WIDE BALL CART

- Made of 1" rugged chrome steel
- Holds 30 full size basketballs
- Comes with heavy duty swiveled rubber casters

1237634 33"H x 45"W x 24"D - 35 lbs. \$449⁹⁹ EA ★

STORAGE EQUIPMENT



MONSTER BALL LOCKER

- Constructed of 1" powder coated steel tubing
- Holds 30 official basketballs or 40 volleyballs
- Features over sized 4" wheels for easy movement
- The top is lockable (lock not included) and contains special hinges and safety chains to prevent top from falling over

1162622 37"H x 47"W x 24"D - 75 lbs. \$999⁹⁹ EA ★



STANDARD PORTABLE BALL LOCKER

- 1" steel tubing frame
- Holds up to 20 basketballs
- Hinged cover can be locked (lock not included)

12002100 43"H x 41"W x 24"D - 35 lbs. \$499⁹⁹ EA ★



WALL MOUNTED BALL LOCKERS

- Constructed of 1" black powder coated steel tubing
- Permanently mounts to your gym wall (hardware not included)
- Holds 6 basketballs; Double model holds 16 basketballs or 30 volleyballs
- Double model includes locking bars at the top and bottom to secure balls (locks sold separately)

1173123 66"H x 15"W x 12"D \$319⁹⁹ EA ★

1162578 66"H x 37"W x 12"D \$399⁹⁹ EA ★



50 BALL CART

- Constructed of 1" O.D. black powder coated steel tubing
- Heavy duty urethane swivel wheels - 2 with brakes
- 5 welded shelves make for easy assembly
- Will hold 50 official size basketballs
- Fits through standard doorways

1378673 64"H x 24"W x 61"L - 61 lbs. \$629⁹⁹ EA ★



MESH BALL CARRIER

- Comes with shoulder strap, vinyl bottom and mesh top fabric

1235654 22"H x 28"W \$49⁹⁹ EA ★



NET BALL CARRIER

- Holds 8-12 volleyballs, soccer balls, basketballs, or footballs

SNBC1XXX White Only \$11⁹⁹ EA ★



MESH DUFFEL BAG

- Open mesh keeps towels and clothing fresh and dry
- Features a full length zipper, handles and shoulder strap
- Color Options: Green, Gold, Orange, Purple, Royal, Scarlet.

4095 15"H x 36"L \$29⁹⁹ EA ★



SPALDING
A ADVANCE PRO COMPOSITE SERIES

- Premium composite cover
- Laminated cover design
- Soft grip TPR lace

WC726548	Official Size	\$39 ⁹⁹ EA
WC726858	Youth, 12-14	\$39 ⁹⁹ EA
WC726868	Junior, 9-12	\$39 ⁹⁹ EA
WC726848	Pee Wee, 6-9	\$39 ⁹⁹ EA

Wilson
B GST COMPOSITE SERIES

- Premium pebble composite leather construction with ACL lacing system
- Official size is NFHS approved

1297287	Official Size	\$45 ⁹⁹ EA
1297294	Youth, 12-14	\$45 ⁹⁹ EA
1297300	Junior, 9-12	\$45 ⁹⁹ EA
1297317	Pee Wee, 6-9	\$45 ⁹⁹ EA

MacGregor
C MC COMPOSITE SERIES

- Tackified composite cover
- Double leather laced and nylon wound carcass

1227697	Official Size	\$27 ⁹⁹ EA ★
1227680	Youth, 12-14	\$25 ⁹⁹ EA ★
1227673	Junior, 9-12	\$25 ⁹⁹ EA ★
1227666	Pee Wee, 6-9	\$24 ⁹⁹ EA ★

NEW!
D ALL FIELD 4.0 COMPOSITE SERIES

- Engineered shape for tighter spirals and a better fit in your hand
- High-Grade composite leather for more tack and an easier catch
- Textured laces help improve your grip in all conditions

Size: Junior, Pee Wee, Official, Youth.

NKN1004469	Select Size	\$30 ⁰⁰ EA
-------------------	-------------	-----------------------

NEW!
E TOURNAMENT 4.0 COMPOSITE SERIES

- Engineered shape for tighter spirals and a better fit in your hand
- High-Grade composite leather helps increase durability
- Two Sewn-In, Bordered stripes give you extra grip points

Size: Junior, Pee Wee, Official, Youth.

NKN1007497	Select Size	\$45 ⁰⁰ EA
-------------------	-------------	-----------------------

Voit
PLAYGROUND TOUGH RUBBER FOOTBALL

- Pebble grained exterior
- Raised molded laces and simulated seams
- All weather, all surface play
- 2 Year Limited Warranty

VCF9SHXX	Official Size	\$17 ⁹⁹ EA ★
VCF7SHXX	Youth, 12-14	\$17 ⁹⁹ EA ★
VCF6SHXX	Junior, 9-12	\$15 ⁹⁹ EA ★
VCF5SHXX	Pee Wee, 6-9	\$15 ⁹⁹ EA ★



Voit
ENDURO RUBBER FOOTBALL W/STITCHED LACES

- Pebble grained sewn rubber panels
- Composite stitched laces
- Butyl bladder for better shape and air retention
- Plays and feels better than a molded rubber ball

1376978	Official Size	\$25 ⁹⁹ EA ★
1376979	Youth Size, 12-14	\$24 ⁹⁹ EA ★
1376980	Junior, 9-12	\$22 ⁹⁹ EA ★



MacGregor
RUBBER FOOTBALL

- Pebble grained exterior
- Raised molded laces and simulated seams
- All weather, all surface play

MCX2LXXX	Official Size	\$17 ⁹⁹ EA ★
MCX2YXXX	Youth, 12-14	\$16 ⁹⁹ EA ★
MCX2JXXX	Junior, 9-12	\$15 ⁹⁹ EA ★



AUTOGRAPH FOOTBALL

- Synthetic leather (PVC) cover
- For display purposes ONLY
- 3 white panels for autographs

1072518	Official Size	\$29 ⁹⁹ EA ★
----------------	---------------	-------------------------



SPALDING
SIGNATURE SERIES AUTOGRAPH FOOTBALL

- Composite cover
- Machine stitched
- Butyl rubber bladder
- 3 white panels for autographs

WC726338	Official Size	\$26 ⁹⁹ EA
-----------------	---------------	-----------------------





SPALDING **NFHS**
APPROVED

A ALPHA

- Horween® "S" tack leather cover with two-ply TPU bladder
- Boxed sewn strip and raised diamond lace
- Official size is NFHS approved

WC726758	Official Size	\$119⁹⁹ EA
WC726748	Youth, 12 - 14	\$74⁹⁹ EA

Nike **NFHS**
APPROVED

B NIKE VAPOR ELITE FOOTBALL

- Made in the U.S.A.
- Constructed with Top-Grain Cowhide
- Engineered for better spin, durability and ball shape
- Specially treated for an enhanced grip
- NFHS Stamped and Approved

NKNIKVE	Official Size	\$129⁹⁹ EA
----------------	---------------	------------------------------

Nike **NFHS**
APPROVED

C VAPOR ONE 2.0 SERIES

- Custom crafted premium tacky leather
- Innovative stitched-in TEXTURED half-stripe
- Official size is NFHS approved

1454495	Official Size	\$110⁰⁰ EA
1454496	Youth, 12 - 14	\$100⁰⁰ EA
1454497	Junior, 9 - 12	\$90⁰⁰ EA

Wilson **NFHS**
APPROVED

D GST LEATHER SERIES

- 863 WE leather construction with tanned-in tack
- Exclusive sewn in grip stripes with ACL Lacing
- Official size is NFHS approved

3F1003	Official Size	\$109⁹⁹ EA
1167931	Youth, 12-14	\$79⁹⁹ EA
1167939	Junior, 9-12	\$79⁹⁹ EA

Wilson **NFHS**
APPROVED

E GST PRIME GAME FOOTBALL NCAA/HS

- Extra grip-point stitching for more accurate passing
- Sewn-on stripe & composite pebbled laces for additional control
- Prep gauge signifies when ball is fully broken-in for game play

WLWTF11031B	Official Size	\$149⁹⁹ EA
--------------------	---------------	------------------------------

Wilson

GST PRIME BLEM FOOTBALL

- Minor cosmetics blemishes or random stamped logos
- Ideal for Practices and Walkthroughs
- **Not permitted for use in Games**

WLWTF11031BS	Official Size - GST Prime Blem	\$139⁹⁹ EA
1405105	Official Size - GST Blem	\$99⁹⁹ EA

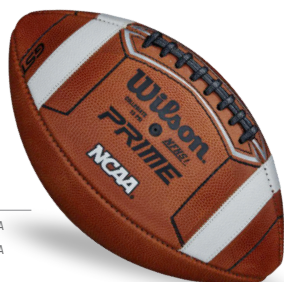

NFHS
APPROVED

SPALDING

J5V ADVANCE

- Top grade Horween® leather
- Rubber four fold polyester backing and rubberized laces
- 4-ply water resistant liner and TPU bladder

WC628999	Official Size	\$99⁹⁹ EA
-----------------	---------------	-----------------------------



Wilson

GAME BALL PREP KIT

- Conditions leather for tack and extended use of game balls
- Wax bar lasts longer for frequent use
- Durable brush withstands rough application and buffing

1375489		\$32⁹⁹ EA
----------------	--	-----------------------------



Mikasa Sports

RUGBY BALL

- Stitched match ball
- Rubber four fold polyester cover
- Butyl bladder for maximum air retention
- Official Size

2 Year Limited Warranty

1303674	Official Size	\$36⁹⁹ EA
----------------	---------------	-----------------------------



FIXED RUNG AGILITY LADDER

- Ideal for developing quick and accurate foot speed, increased balance and coordination
- Each ladder is 15'L x 20"W with ten sections
- Rugged 1" wide webbing with end buckles allow various shape configurations for a more diversified workout
- Connecting buckles allow for additional ladders for longer runs and different formations
- Includes carry bag



1271560 \$64⁹⁹ EA ★



COLLEGIATE LINEMAN CHUTE



- Double overhead bars keep players low at snap and allows them to rise after first few steps of drive
- Sturdy build 2" Galvanized Steel tubing
- Designed to slide easily across fields with no damage to turf
- Entrance height is 45" and exit height is 52"
- Assembled dimensions – 48"W x 60"L
- 1 man base unit required and then add on as many sections as needed
- Weighs 68.5 lbs.

1272987 Base Unit \$459⁹⁹ EA ★
1272994 Add-a-Chute \$349⁹⁹ EA ★



RUNNING ROPES

- Frame constructed of powder-coated 17-gauge steel tubing
- Exclusive frame design keeps all tubing safely away from the training path
- Optic yellow nylon step grid is 14' 10"L x 3' 3"W
- Frame dimensions: 18' 6"L x 4' 6"W, grid adjusts from 6" to 15" H
- Step grid connects to frame with bungee cords



1201987 Complete Unit \$399⁹⁹ EA ★
1201994 Replacement Running Grid \$119⁹⁹ EA ★



VARSITY LINEMAN CHUTE

- Heavy-walled 1 5/8" powder coated steel tubing
- Entrance height is fixed at 40" and exit height is fixed at 48"
- Assembled dimensions: 50"L x 50"W
- Includes hardware to link multiple chutes together



FBVCHUTE \$269⁹⁹ EA ★



ADJUSTABLE LINEMEN SPLIT MARKER

- Heavy-duty vinyl construction w/ weights at the ends & center keeping it flat on the ground
- The labeled removable positions attaching a hook-&-loop fastening strip to customize formations
- 39"L overall, 10.5"W black strip with 36"L yellow position indicators labeled with 9"H letters
- Great for teaching linemen and backs splits and gaps



200234007 \$229⁹⁹ EA ★

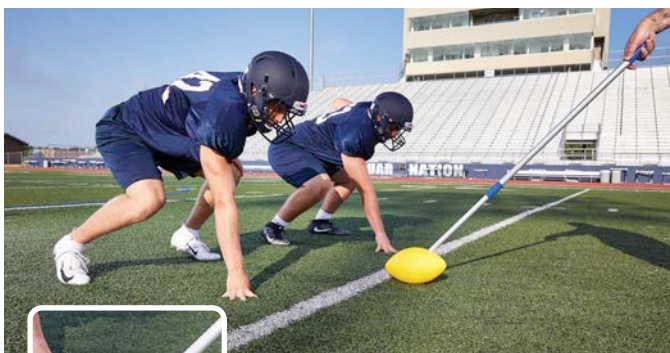

SNAPPER STICK

- Aluminum pole with foam rubber football
- Teach players to react to ball movement not cadence
- Telescoping aluminum pole extends from 30" to 60"
- Allows coach to stand instead of kneeling



1299939 \$79⁹⁹ EA ★



PRO-DOWN

CARRY BAG SOLD SEPARATELY.

VARSITY KICKING CAGE

- Heavy-duty 1 1/2" round 17-gauge galvanized steel frame
- Optic yellow sides help kickers visualize goal post
- Assembles and disassembles easily for travel and storage
- 82"H x 41"W x 41"D - 27 lbs.
- Carry bag sold separately

1052480	Complete Unit	\$329 ⁹⁹	EA ★
1052473	Replacement Net Only	\$74 ⁹⁹	EA ★
1363685	Carry Bag	\$99 ⁹⁹	EA ★



BOW

CARRY BAG INCLUDED!

SOLO KICKER

- Unique design makes it the most portable practice Kicker net ever
- Powder coated steel ground frame, and composite Bow Poles
- No tools needed and sets up easily in 90 seconds.
- 7'4"H x 4'W x 5'6"D - 23 lbs.
- Includes carry bag

1367618	Complete Unit	\$499 ⁹⁹	EA
----------------	---------------	---------------------	----



PRO-DOWN

PASS AND SNAP TRAINER

- Steel powder coated base and anodized aluminum upper frame
- 4'H x 4'W pocket with movable target
- Adjust pocket from 30 to 90 degrees
- 6" heavy-duty casters

FB0BTXXX	96"H x 51"W x 48"D	\$999 ⁹⁹	EA ★	S&H
FB0BTN	Replacement Net	\$124 ⁹⁹	EA ★	



SOCCER STYLE KICKING TEE

- Unique design allows soccer style kickers to make contact with the ball first, instead of the tee
- Weighted for stability

MSSKTRFX	Right Footed Kicker	\$8 ⁴⁹	EA ★
MSSKTLFX	Left Footed Kicker	\$8 ⁴⁹	EA ★



PLACEKICK TEE

- Heavyweight black rubber tee
- Serrated bottom for holds on grass or turf

1405565	1 in.	\$5 ⁹⁹	EA
MSPATXXX	2 in.	\$8 ⁴⁹	EA ★



GROUND ZERO

GROUND ZERO KICKING TEE

- Heavy duty black rubber tee
- 1" includes on-side kick feature; 2" does not
- Used by NFL Super Bowl teams

FBGZ1	1"	\$26 ⁹⁹	EA ★
1405590	2"	\$27 ⁹⁹	EA



WIZARD KICKING STIX[®] FOOTBALL HOLDER

- Durable powder coated steel and aluminum construction
- Riveted legs for easy, quick fold-up design
- Works with or without place kick tee
- Football sold separately

1363687		\$37 ⁹⁹	EA
----------------	--	--------------------	----



Sport Write!

COACHING TOOLS

PRO FOOTBALL DRY-ERASE BOARDS

- Large format enables entire team to see play
- 2 writing surfaces
- Includes pen clip with dry erase marker

1405760	12.5"H x 16.5"W - 2lbs.	\$36 ⁹⁹	EA
----------------	-------------------------	--------------------	----



FOOTBALL PLAYMAKER

- 18"H x 24"W dry erase coaching board with handle
- Football field on one side with play diagrams on other side
- Includes dry-erase pen that attaches to the board with Velcro

1299793		\$49 ⁹⁹	EA
----------------	--	--------------------	----

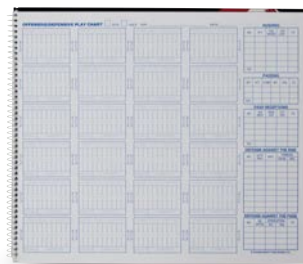

FOOTBALL STAT BOOK

- Simplified instructions for charting offensive and defensive plays
- 11 game stat book with 24 play charts per quarter

1197631		\$29 ⁹⁹	EA
----------------	--	--------------------	----



KICKOFF TEE

- Universal style rubber kicking tee

1405560	1 in.	\$5 ⁹⁹	EA
MASKICKOF	2 in.	\$7 ⁴⁹	EA ★



Wilson

PRO KICK

- Collapsible sturdy all-metal construction
- Holds any size football to the desired angle
- Works with or without kicking tee
- Football sold separately

1008579		\$39 ⁹⁹	EA
----------------	--	--------------------	----

PRO DOWN

- Double-reinforced 18 oz. vinyl shell
- Durable foam interior

- Black ProDown in stock*
- Other colors ship from Fisher Athletic with Fisher logo. Allow 2-3 Weeks for delivery



COLLEGIATE SHIELD

- 2 reinforced handles
- 16"W x 26"L - 4 lbs.

200232812 Black Only - 6"H **\$119⁹⁹** EA ★
1393022 Specify Color - 4"H **\$119⁹⁹** EA



MAN SHIELD

- 22"W x 26"L x 5"H - 5 lbs.; 4 reinforced handles

1384302 Royal **\$169⁹⁹** EA ★
1384303 Black **\$169⁹⁹** EA ★



PRO SHIELD

- 2 reinforced handles
- 16"W x 42"L x 4"H - 5 lbs.

200234412 Black Only **\$129⁹⁹** EA ★



FOREARM SHIVER PADS

- 24" x 11.5" x 3"
- Shock foam pad with nylon-reinforced cover
- Protects hand and forearm area

200232412 Black Only **\$49⁹⁹** EA ★



MULT-PURPOSE EQUIPMENT WAGON

- All steel construction with pneumatic tires
- Use for carrying equipment, water containers, or field storage
- Front, rear, and side panels fold away for easy loading/unloading
- 1400 lb. weight capacity

1291766 **\$599⁹⁹** EA ★
1334647 Optional Hook Set **\$29⁹⁹** SET



FOOTBALL FIELD EQUIPMENT CART

- Heavy duty cart designed to easily transport football sideline equipment
- J-Hooks and strap to carry down marker and chain set
- Steel frame with sturdy expanded metal deck to prevent standing water
- Sized right to carry pylons, sideline markers and goal post pads
- Maneuvers easily with semi-pneumatic casters and pull handle
- Equipped with optional use towing attachment

1378681 47"L x 33"W x 37"H - 120 lbs. **\$899⁹⁹** EA ★ 

SHIELD DUMMY COLOR CHOICES: CHOOSE FROM 11 SCHOOL COLORS

COLORS OTHER THAN BLACK SHIP FROM FISHER ATHLETIC WITH FISHER LOGO.

BLACK*

DARK GREEN

GRAY

KELLY

MAROON

NAVY



- Double-reinforced 18 oz. vinyl shell
- Durable foam interior
- Black ProDown in stock
- Other colors ship from Fisher Athletic with Fisher logo. Allow 2-3 Weeks for delivery



ROUND BLOCKING DUMMY

- 2 reinforced handles

200235312
1393055

13"W x 38"L - 10 lbs. - Black Only
13"W x 38"L - 10 lbs. - Specify Color

\$289⁹⁹ EA ★
\$289⁹⁹ EA



HEAVY ROUND BLOCKING DUMMY

- 2 reinforced handles

200235112
1393267

14"W x 48"L - 20 lbs. - Black Only
14"W x 48"L - 20 lbs. - Specify Color

\$299⁹⁹ EA ★
\$319⁹⁹ EA



STEP-OVER DUMMIES

- Handles on ends and bottom

200230812
1393279
200231212
1393290

17"B x 8"H x 51"L - 10 lbs. - Black Only
17"B x 8"H x 48"L - 20 lbs. - Specify Color
17"B x 12"H x 51"L - 20 lbs. - Black Only
17"B x 12"H x 48"L - 30 lbs. - Specify Color

\$199⁹⁹ EA ★
\$279⁹⁹ EA
\$299⁹⁹ EA ★
\$319⁹⁹ EA



SQUARE BLOCKING DUMMY

- 2 reinforced handles

200235012
1393044

14"W x 50"L - 15 lbs. - Black Only
14"W x 50"L - 14 lbs. - Specify Color

\$299⁹⁹ EA ★
\$309⁹⁹ EA



REPLACEMENT DUMMIES FOR OUTDOOR SLEDS

- Polyurethane foam filling covered with durable 18 oz. vinyl
- Seams are double stitched with heavy-duty nylon thread for added durability
- Cone pad only includes handles to allow for dummy use without sled
- Cone and Man pad in stock in Royal Blue only
- Cone pad dimensions: 48"H x 18" Top Diam x 13" Bottom Diam
- Man Pad dimensions: 48"H x 28"W x 10"D

1296259

Pro Pad - Royal Only

\$699⁹⁹ EA ★

DUE TO DYE LOTS AND NATURAL VARIATIONS, VINYL COLORS MAY VARY SLIGHTLY IF ORDERED AT SEPARATE TIMES.

ORANGE

PURPLE

RED

ROYAL

GOLD

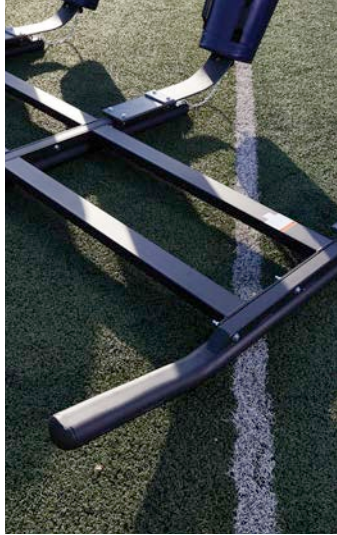

VARSITY M-SERIES BLOCKING SLEDS

- All steel powder coated frame construction
- Modular frame construction allows for convenient expansion or removal of a man when needed
- Features 52" splits
- Super-Duty flat leaf springs absorb initial shock and recoils with equal force
- Round tubular steel "all surface" skids
- Optional Coaches Platform available
- Comes stock with royal blue

5 Year Limited Warranty

1378632	2-Man with Royal Pro Pads	\$2,649 ⁹⁹ EA ★ S&H
1378633	3-Man with Royal Pro Pads	\$3,899 ⁹⁹ EA ★ S&H
1378634	4-Man with Royal Pro Pads	\$5,199 ⁹⁹ EA ★ S&H
1378635	5-Man with Royal Pro Pads	\$6,399 ⁹⁹ EA ★ S&H
1378636	6-Man with Royal Pro Pads	\$7,499 ⁹⁹ EA ★ S&H
1378637	7-Man with Royal Pro Pads	\$8,499 ⁹⁹ EA ★ S&H
1362618	Optional Coaches Platform	\$349 ⁹⁹ EA ★ S&H



M-SERIES 1-MAN SLED

- All steel powder coated frame construction
- Super-duty flat leaf springs absorb shock and bounce back providing maximum recoil
- Tubular steel skids for durability and performance on all field types
- Stock pads available in cone or pro pad design in royal blue

1271522	Royal Pro Pad - 230 lbs.	\$1,499 ⁹⁹ EA ★ S&H
----------------	--------------------------	---



YOUTH BLOCKING SLEDS

- All steel powder coated "modular frame construction" allows you to add or remove a man from the sled as desired
- Super-Duty flat leaf springs absorb initial shock and returns it with equal force
- Powder coated tubular steel skids can be used on all field surfaces
- These sleds are ideal for the 11 to 15 year old age group
- Features 42" splits

5 Year Limited Warranty

1362612	2 Man with Royal Pro Pads - 265 lbs.	\$2,199 ⁹⁹ EA ★ S&H
1362613	3 Man with Royal Pro Pads - 405 lbs.	\$2,899 ⁹⁹ EA ★ S&H
1362615	5 Man with Royal Pro Pads - 690 lbs.	\$4,499 ⁹⁹ EA ★ S&H
1362617	7 Man with Royal Pro Pads - 970 lbs.	\$5,999 ⁹⁹ EA ★ S&H
1362618	Optional Coaches Platform	\$349 ⁹⁹ EA ★ S&H

GOOSENECK FOOTBALL GOAL POSTS

- Newly re-designed with enhanced features for easier assembly and installation (some drilling in the field is required)
- Meets NFSHSA specifications with 23' 4" Crossbar
- 4-1/2" O.D. main gooseneck with 5' offset with 4-1/2" O.D. Crossbar
- 2-3/8" O.D. uprights with choice of 20' or 30' height
- Two-piece 30' uprights (20' and 10')
- Permanent installation or Optional Ground Sleeves available for semi-permanent installation
- Sold in Pairs

5 Year Limited Warranty

High School Crossbar 23'4"

1399646	Yellow - 20' Upright	\$6,599⁹⁹ PR ★ 
1399649	Yellow - 30' Uprights	\$7,699⁹⁹ PR ★ 
1399644	White - 20' Uprights	\$6,599⁹⁹ PR ★ 
1399647	White - 30' Upright	\$7,699⁹⁹ PR ★ 
1399656	Optional Ground Sleeves	\$1,999⁹⁹ PR ★ 
1197747DS	Wind Direction Flags (4/Set)	\$19⁹⁹ SET

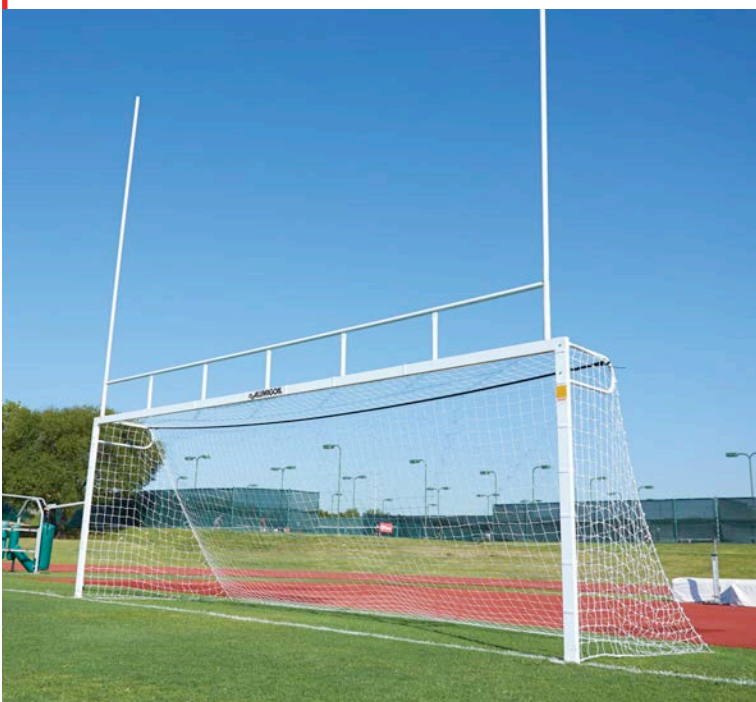

FOOTBALL/SOCCER COMBO GOAL

- Meets High School soccer and football regulations
- 10'H football uprights are constructed of 2" square aluminum tubing
- Width of uprights can be adjusted for H.S. (23'4") or Collegiate (18'6") play or removed for soccer play
- Soccer goal size - 8'H x 24'W x 3'D
- Soccer post are constructed of 11 gauge 2" x 4" steel tubing
- Crossbars are constructed of 14 gauge 2" x 4" steel tubing
- Euro style backstays are constructed of 14 gauge - 1.5" steel tubing
- Goals include backstays, 4mm soccer nets, net fasteners and ground stakes

SGFBCOM	1 Pair of Goals - Includes Nets	\$4,999⁹⁹ PR ★ 
1367769	4mm - Replacement Net	\$449⁹⁹ PR ★
1308082	Ground Sleeves - 4/Set	\$279⁹⁹ SET ★

PROTECTIVE POST PADS

- 6'H post pad constructed of 4" thick high-density urethane foam encased in 18 oz. vinyl
- Available in two sizes with hook-and-loop closure design
- Please specify color. Red and Royal Blue in stock.

1362696	Hook & Loop up to 4 1/2" O.D. Post	\$449⁹⁹ EA ★
1366530	Hook & Loop 4 1/2" - 5 1/2" O.D. Post	\$469⁹⁹ EA ★

PROTECTIVE POST PADS - CUSTOM

- 6'H post pad constructed of 4" thick high-density urethane foam encased in 18 oz. vinyl
- Available in two sizes with hook-and-loop closure design
- Customization available for an additional charge
- Allow 4 - 6 weeks for delivery

G808YV4XDS	4-1/2" O.D. Post	\$619⁹⁹ EA
G808YV6XDS	5 1/2" O.D. Post	\$679⁹⁹ EA 

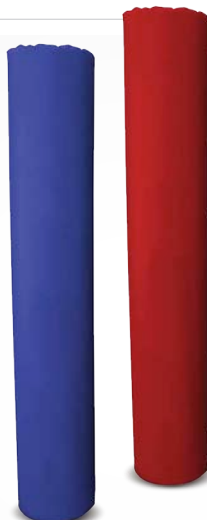

OPTIONAL LETTERING FOR CUSTOM POST PADS

- Add up to (8) 8" letters to your post pads
- Letters will be one-color or two-color block style
- Please allow 4 - 6 weeks production time

G000YXXXDS	One-Color	\$229⁹⁹ EA
-------------------	-----------	------------------------------

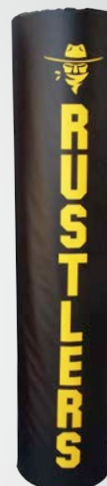



SOLID SIDELINE MARKERS WITH HANDLE

- Vinyl covered foam with weighted bottom
- 15”H x 15”W with 10”H numbers
- 11 piece set includes: 2-G, 2-10, 2-20, 2-30, 2-40, 1-50
- 5 piece set includes: 2-G, 2-20, 1-40

1249361	11 Piece Set	\$499⁹⁹ SET ★
1249378	5 Piece Set	\$249⁹⁹ SET ★



DAY/NIGHT SIDELINE MARKERS

- Soft, crushable foam core inside durable vinyl cover
- Improved with better visibility for day or night games
- Folding design for flat storage
- Hook and loop fasteners with weighted bottom to maintain upright position
- 15”H X 15”W with 13”H numbers
- 11 piece set includes: 2-G, 2-10, 2-20, 2-30, 2-40, 1-50

1249347	11 Piece Set	\$579⁹⁹ SET ★
1249354	2-G, 2-20, 1-40	\$279⁹⁹ SET ★



STACKABLE SIDELINE MARKERS

- 13”H, 3 sided pyramid shaped markers
- Made of tough, flexible vinyl
- Stackable for easy storage
- 5-piece set includes: 2-G’s, 2-20’s, 1-40
- 11-piece set includes 2/G’s, 2/10’s, 2/20’s, 2/30’s, 2/40’s, 1/50

1245127	5 Piece Set for Flag Football	\$279⁹⁹ SET ★
1245134	11 Piece Set	\$499⁹⁹ SET ★



PYLONS

- Bright, fluorescent orange
- Safe foam filled vinyl
- 18”H x 4”W x 4”D
- Set of 4

MSWPYLON	Weighted Anchorless	\$79⁹⁹ SET OF 4 ★
-----------------	---------------------	-------------------------------------



MOLDED FOAM PYLONS

- Solid Molded Foam construction
- Anchor weight molded into bottom
- Won’t puncture or loose weight
- Bright Orange
- For use on grass or turf fields

1453456	Set of 6	\$379⁹⁹ SET ★
----------------	----------	---------------------------------



WEIGHTED PYLONS WITH CUSTOM PRINT

- Weighted pylons with orange vinyl cover
- 4” x 4” x 18” H
- Customize with your school mascot or other logo on all four sides
- Print in multiple colors up to 3-1/4” wide
- Allow 2 to 3 weeks for delivery after art approval

1453076	4/Set	\$299⁹⁹ SET
1453077	8/Set	\$379⁹⁹ SET
1453078	12/Set	\$699⁹⁹ SET

BUY THE PACKAGE AND SAVE!

DOWN INDICATORS AND CHAIN SETS

- Fully padded poles, indicator boxes, banners and bulls-eyes
- Down indicator is available in 7' 4" H padded flip style or 8' padded mechanical style with slide levers for changing down numbers
- 8' H chain sets with "Bulls-eye" design feature a two-piece pole, galvanized steel chain, swivel snap hook, molded ground stops and rubber ends.
- Fully padded banners are available in high visibility solid orange, chevron, or diagonal pattern
- J.V. chain set comes with single-ply solid orange banner



	Down Indicator Only	J.V. Chain Set & Down Indicator	Diagonal Chain Set & Down Indicator	Solid Chain Set & Down Indicator	Chevron Chain Set & Down Indicator
Flip Indicator	A. 1370767 \$329 ⁹⁹ EA ★	1376988 \$529 ⁹⁹ SET ★	FBCOLSET \$499 ⁹⁹ SET ★	1379285 \$549 ⁹⁹ SET ★	1379286 \$599 ⁹⁹ SET ★
BSN SPORTS Pro-Style Indicator	B. FBPROBOX \$549 ⁹⁹ EA ★	1379287 \$699 ⁹⁹ SET ★	1375486 \$749 ⁹⁹ SET ★	FBPROSET \$799 ⁹⁹ SET ★	1375487 \$799 ⁹⁹ SET ★
	J.V. Chain Set Only	Diagonal Chain Set Only	Solid Chain Set Only	Chevron Chain Set Only	
	1370765 \$349 ⁹⁹ SET ★	FBPROCSX \$329 ⁹⁹ SET ★	1370766 \$379 ⁹⁹ SET ★	1371543 \$399 ⁹⁹ SET ★	



PRO DOWN CHAIN SET CARRY BAG

- Will hold one complete chain set and down indicator
- Heavy-duty 600 Denier polyester construction
- Rugged nylon zipper with wrap around handles and shoulder strap
- Size: 99"L x 17.5"H x 5.25"W

1310351 Black Only \$149⁹⁹ EA ★



EDOWN DIGITAL DOWN MARKER

- 15" Super-Bright Red LED Digit
- One-Button Operation
- Lightweight – Under 9 lbs.
- Rechargeable NiMH Battery Pack (Located in Pole)
- Weatherproof Design for All Playing Conditions
- Lexan Housing is Practically Indestructible
- 8+ Hours of Operation on a Single Charge
- LED Battery Charge Indicator
- Smart Battery Charger Included (Will Not Overcharge Battery)

1453100 8' High \$2,099⁹⁹ EA



BSN SPORTS[™] ELECTRONIC DOWN MARKER

- One touch control to switch between downs
- Dual brightness settings with bold 13" tall numbers
- Great for day and night games
- 7 hour rechargeable battery
- Lightweight design at 13 lbs.
- Fully padded with round corners
- Durable and water resistant
- Includes protective rain cover

1451723 8' High \$1,999⁹⁹ EA

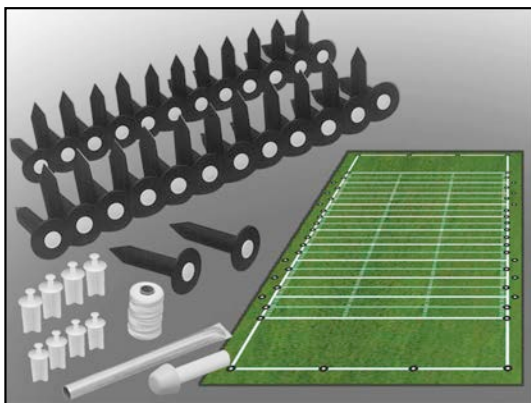

FOOTBALL FIELD LINING SET

- Set includes 50 sockets with plugs
- Installation accessory kit
- Marks complete football field - 5 yard increments, goals and hash marks

MKFLP50

\$524⁹⁹ EA

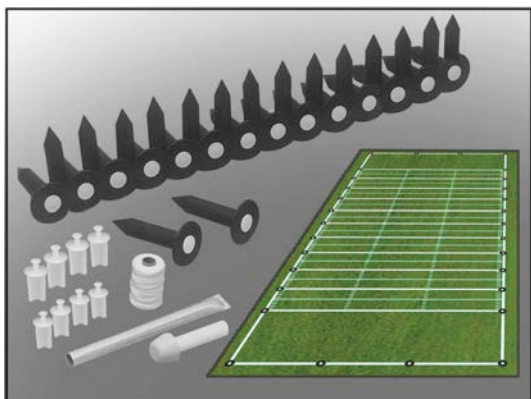

FOOTBALL PRACTICE OR BAND LINING SET

- Set boundary lines, goal lines, every ten yard lines and hash marks
- Great for band practice fields as well
- Set includes 30 sockets with plugs
- Installation accessory kit

MKPLP30

\$354⁹⁹ EA

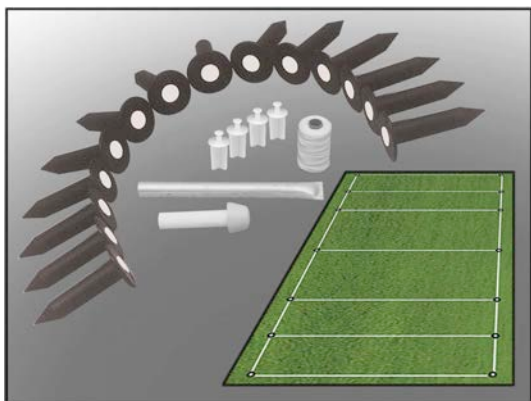

MARKSMART™ INTRAMURAL LINING PACKAGE

- Most intramural and club sports require 14 line intersection reference points of the field
- Everything you need to establish permanent reference locations for flag football, lacrosse, field hockey, rugby and others
- Set includes: 14 sockets w/plugs and installation accessory kit

MKILP14

\$199⁹⁹ EA

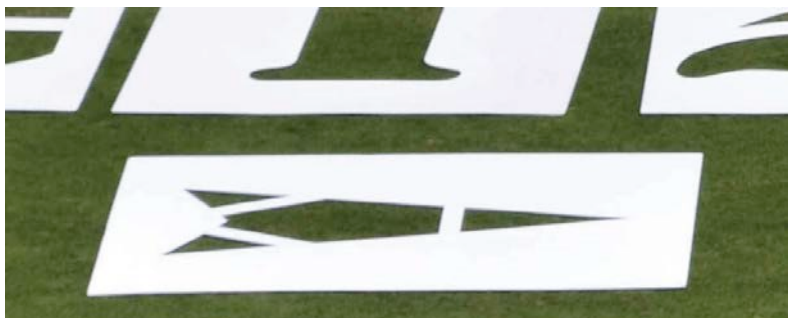

PRO STYLE FIELD STENCILS

- Durable 1/8" flexible plastic stencils (Low-Density Polyethylene, LDPE)
- Can be rolled up for storage, and then flattened back out without any curl
- Sheds paint with ease and won't crack or break
- Each piece measure 8' x 4' with 6" numbers
- Standard Package contains: G, 1,2,3,4,5,0
- Deluxe Package contains: G, 1,2,3,4,5,0, hashmark, directional arrow

1461151	Standard Package	\$889 ⁹⁹ SET
1461152	Deluxe Package	\$1,239 ⁹⁹ SET
1461153	Individual Number	\$144 ⁹⁹ EA
1461154	Directional Arrow	\$144 ⁹⁹ EA
1461155	Hash Mark	\$429 ⁹⁹ EA

FM ACCESSORIES

GROUND SOCKET CAPS

- 12 pack of plugs for MarkSmart ground sockets
- Use color coded cap for multiple field configurations

Color Options: **Orange, White, Yellow.**

MKA103Y Caps Only - Specify Color \$21⁹⁹ DZN

GROUND SOCKET WITH CAP

- Individual 8" ground socket with plug

MKA101 Ground Socket with Plug \$12⁹⁹ EA

HEAVY DUTY POLYESTER TWINE IN 500 FOOT ROLL

- Heavy duty twisted polyester rope.

MKA102 \$29⁹⁹ EA

GROUND SOCKET LINING PEGS - 10/SET

- 10 pack of lining pegs for MarkSmart lining system
- Insert in ground sockets to attach twine

MKA104 \$19⁹⁹ SET

GROUND SOCKET AUGER

- Use to set your ground sockets in place
- Attaches to any standard drill; size: 3/8" shaft, 1 1/4" diameter, 12" length

MKGSAT2 \$35⁹⁹ EA

GROUND SOCKET PUNCH-PILOT HOLE TOOL

- Easy to use pilot hole tool for ground socket installation
- Helps to remove soil/dirt and create a crevice for ground socket insertion

MKA105 \$44⁹⁹ EA

PAIR OF GROUND SOCKET SETTERS

- Designed to be placed in the ground socket so you can hit these instead of the ground socket directly

MKA106 \$7⁹⁹ PR

TWINE OR CORD REEL - NO TWINE INCLUDED

MKTCR10 \$28⁹⁹ EA

TWINE REEL WITH 500 FEET OF HEAVY DUTY POLYESTER ROPE

Includes 500 feet of heavy duty polyester twine

MKTCR638 \$44⁹⁹ EA

NEW!

DURASTRIPE MARKING PAINT

- 20oz cans with 18oz by volume
 - Non-clogging, cans will empty completely
 - Safe for user, environment and all varieties of grass
 - Extremely durable, will not wash away with rain and elements
 - Aerosol cans come standard with a custom "T" spray for a crisp, wide athletic field lines
- Color Options: **Colt Gray, Handicap Blue, Brown Line, Syracuse Orange, North Carolina Blue, Vanderbilt Gold, Turf Green, Aluminum, Black, Brown, Burgundy, Burnt Orange, Cardinal, Clear, Columbia Blue, Augusta Green, Old Gold, GRAY, Green, Maroon, Navy, Orange, Pink, Purple, Red, Royal, Tan, Teal, Team Orange, Vegas Gold, White, Yellow.**



1460342

Case of 12 Cans-Specify Color

\$109.99 CASE ★



NEW!

STRIPING MACHINE WITH 10" WHEELS

This striping machine is perfect for everyday field striping. It's 10" diameter wheels make for a smooth roll and less effort.

1460691

\$299.99 EA ★



NEW!

STRIPING MACHINE ALL TERRAIN WHEELS

This machine is equipped with large diameter ALL TERRAIN wheels that roll smoothly and maneuver easily over rough field conditions.

1460692

\$449.99 EA ★



ECOLINER™ BATTERY POWERED FIELD STRIPING MACHINE

- Features a heavy duty, diaphragm pump powered by a 12-volt deep cycle battery, never flat tires and all steel construction
- Quickly paint professional quality lines for hours on a single battery charge
- Simply, place a 5-gallon pail of premixed paint on the machine and you are ready to mark your field
- No pressurized tanks. No need to release pressure to add paint or clean. No high-pressure pump output to prohibit operator injury
- Line width is fully adjustable from 2"-6", allowing for greater flexibility to meet your field marking needs
- Equipped with a quick charge 120V plug in battery charger to provide the fastest charging time available.

18 Month Limited Warranty

5NSECLNR

5 Gallon Capacity

\$2,249.99 EA



FIELDLAZER™ STRIPER

- Exclusive tall-wheel cart rolls easily over ruts and cleat marks
- Easy out filter makes tip clogs a thing of the past
- 35cc Honda 4 stroke engine
- Three semi pneumatic 14" tires
- 900 psi
- Gas tank holds .65 gallons and should be good for 45 minutes
- Adjustable spray shields make line width changes from 4"-8" fast and easy with no tools
- Siphons from the original 5 gallon paint container to eliminate tank and pot cleaning hassles
- Fold-down handle makes transportation easy; Weight: 80 lbs.

1179477

1236286

5 Gallon Capacity
30" Tip Extension

\$4,899.99 EA
\$129.99 EA



RAZOR

FEATURES



MOISTURE WICKING FABRICS

Moisture wicking inner and outer fabrics featuring Aegis antimicrobial treatment enhance cooling performance and inhibit bacteria growth.



ADJUSTABLE PROTECTIVE PADS

Perforated closed cell foam clavicle channel pads (All models) and EVA foam deltoid pads (RZ15 only) can be positioned or removed for precise fit and coverage in the key hitting areas.

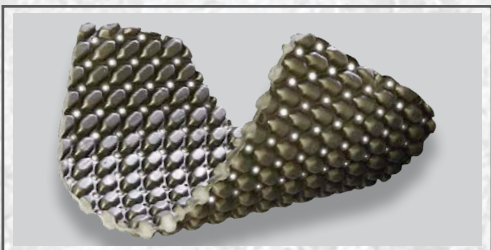

COMPRESSED HEX FOAM

Compressed closed cell HEX Foam features 3D channels and perforations to promote airflow, moisture evaporation and cooling performance.





PAD-LOC BUCKLE SYSTEM

Industry first belt attachment system, features injection molded plastic buckle/housing with automotive grade web strap and padded, protective buckle slider pad. The “tongue and groove” buckles lock into place in the recessed housing for a flush mount and no grab points.



REMOVABLE COMFORT LINER

HEX Foam comfort liner attaches with hook and loop fasteners and can be removed for hand washing and air drying.



STERNUM/SPINE PROTECTIVE PADS

Floating perforated and layered EVA and Compressed HEX Foam sternum and spine pads provide an extra layer of protection without sacrificing flexibility.



GEAR
PRO·TEC

RAZOR





RZ7

SKILL

- Slim profile with shorter caps for increased mobility and unrestricted arm movement for the most flexibility
- Average weight - 4.55 lbs. (size L)

1388367

Specify Size (SM - 2XL)

\$369.⁹⁹ EA ★

SIZE	SM	MD	LG	XL	2XL
SHOULDER	16"-17"	17"-18"	18"-19"	19"-20"	20"-21"
CHEST	36"-38"	38"-40"	40"-42"	42"-44"	44"-46"



RZ15

MULTI-POSITION

- Wider side cut, extended cap and protective deltoid pad for the most coverage and greatest protection in the RAZOR line up
- Average weight - 4.85 lbs. (size XL)

1388373

Specify Size (SM - 2XL)

\$369.⁹⁹ EA ★

SIZE	SM	MD	LG	XL	2XL
SHOULDER	16"-17"	17"-18"	18"-19"	19"-20"	20"-21"
CHEST	36"-38"	38"-40"	40"-42"	42"-44"	44"-46"



RZ55

OL/DL

- Extremely narrow side cut for smallest surface area and generous neck opening for freedom of movement gives big guys what they need for performance in the trenches
- Molded foam caps for reduced weight and snug fit
- Average weight – 4.35 lbs. (size XL)

1388380

Specify Size (MD - 3XL)

\$369.99 EA ★

SIZE	MD	LG	XL	2XL	3XL
SHOULDER	17"-18"	18"-19"	19"-20"	20"-21"	21"-22"
CHEST	38"-40"	40"-42"	42"-44"	44"-46"	44"-48"



RAZOR

RIB PROTECTOR

- Sas-Tec Foam with corrugated exterior shell located in center back for superior impact absorption
- Compressed Hex foam with rigid side and front panels provides best in class protection, moisture evaporation and cooling performance.
- Universal T-nut and screw attachment fits all Razor and Z-Cool shoulder pads as well as most competitor's shoulder pads

1455078

Specify Size (SM - LG)

\$64.99 EA ★

SIZE	SM	MD	LG
WAIST	34"-38"	40"-44"	46" and up



RAZOR

BACK PLATE

- Features Compressed HEX Foam side panels with a SAS-TEC foam spine insert and corrugated exterior shell for maximum protection
- Universal T-nut and screw attachment fits all Razor and Z-Cool shoulder pads as well as most competitor's shoulder pads

RZ BACK PLATE	1390930	1388433
SIZE	SM	LG
DIMENSIONS	9.5"x6"	12"x7"
PRICE	\$34.99	\$39.99



Z-COOL 2.0

FEATURES



IMPROVED EPAULET CURVATURE

Provides better shoulder coverage and fits modern jersey cuts

RIGID PLAS

ADJUSTABLE DELTOID PAD SYSTEM



PRO-LOC EPAULET DESIGN



AC NOTCH-OUT WITH FIXED CAP PAD

Provides Acromioclavicular joint protection. No direct pressure on AC joint

MOISTURE WICKING ANTI-MICROBIAL FABRIC



Z-COOL 2.0 TECHNOLOGY

PROTECTIVE STERNUM PROTECTION



1.5" BIOTHANE BELTS WITH NON-CUT BUCKLES
With 3-point rear strap attachment for better fit (Patent #D543,488)

EXCLUSIVE AIR RELEASE™ SYSTEM



Adjustable and removable waterproof clavicle channel pads provide a custom fit for individual player comfort and maximum safety. Patent #5,701,611



Layered foam cushions impact by quickly forcing air through vents in the pad sidewall. Each pad quickly rebounds to be ready for the next impact.

Z-COOL® MOISTURE TRANSFER SYSTEM



Patented High Impact Inner Poly Arch design featuring vent holes front and back is sandwiched between two layers of 3-D Air Flow Brock® Foam and supported by an outside Poly Plate. Patent #7,168,104

HOW Z-COOL® WORKS

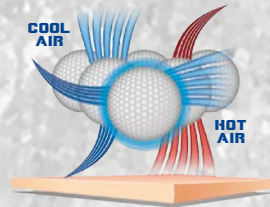

1. ACTIVE AIR CIRCULATION:

3-D Air Flow Brock® Foam allows air to circulate through the pad in three dimensions. As sweat coats the surface area of the waterproof foam beads, the airflow actively accelerates evaporation which is the key to body temperature cooling and post-game drying time.



2. IMPACT ENERGY DISPERSION:

Z-Cool® shoulder pads feature Brock® Foam giving them an advantage over the standard open cell foam. Upon impact, each bead in the Brock Foam padding dissipates and redistributes energy waves to the connected adjacent beads.

3. ENHANCED PERFORMANCE:

The benefits of Z-Cool® technology provide athletes with an extra edge on the competition. A perfect combination of materials and engineering to cool the athlete's body by wicking away perspiration and protecting athletes with superior impact dispersion. An ultra-light design that allows athletes at all levels to perform at their very best... in the very best.



ZC SKILL

- Flat pad design for low profile with all of the features needed to provide protection and improved mobility required for all skill positions
- Extended flexible arches for superior speed and mobility that are rigid and durable enough to handle the big hits
- Lightweight design with extended arch protection features fixed cap pads, making this a good choice for read option quarterbacks, wide receivers and defensive backs.

1454155

Specify Size (XS - XL)

\$259⁹⁹ EA ★

SIZE	XS	SM	MD	LG	XL
SHOULDER	15"-16"	16"-17"	17"-18"	18"-19"	19"-20"
CHEST	34"-36"	36"-38"	38"-40"	40"-42"	42"-44"



BACK



FRONT





ZC MULTI POSITION

- Advanced technology provides excellent impact absorption, ideal body fit and maximum freedom of movement
- This pad offers the best protection for all aspects of the game
- Wider front and back arch coverage designed for bigger players needing maximum protection on impact

1454161

Specify Size (SM - 2XL)

\$259⁹⁹ EA ★

SIZE	SM	MD	LG	XL	2XL
SHOULDER	16"-17"	17"-18"	18"-19"	19"-20"	20"-21"
CHEST	36"-38"	38"-40"	40"-42"	42"-44"	44"-46"



BACK



FRONT





OL/DL

- Super streamlined arch cut delivers unsurpassed shoulder and arm mobility
- Deep, open neck design offers greater range of motion and unrestricted lateral head movement.

1454168

Specify Size (M - 4XL)

\$259⁹⁹ EA ★

SIZE	MD	LG	XL	2XL	3XL	4XL
SHOULDER	17"-18"	18"-19"	19"-20"	20"-21"	21"-22"	22"-23"
CHEST	38"-40"	40"-42"	42"-44"	44"-46"	46"-48"	48"-50"



BACK



FRONT



POST GAME REACTION

“Our players love the fit and feel of our Gear shoulder pads. We have used them since our football program’s inception in 2009. Our absence of shoulder and upper-body injuries, combined with competitive pricing and unrivaled customer support shows that you can’t go wrong with Gear products.”

Adam Howard - Head Football Coach, Notre Dame College of Ohio

“I’ve found that Gear shoulder pads have provided our program with great protection for our athletes. We have used the Gear pad for the last 10+ years and their durability is the best by far. Many other pads have failed during reconditioning within 5 years of being purchased. Gear pads stay in great shape...even after 10 years of use!”

John Livengood - Head Football Coach – Norwalk St. Paul High School

“The Z-Cool pads provide great protection for our players, and the fact that they are lightweight helps our players’ performance on the field. The Z-Cool Pads are also very “clean” pads. They dry quickly and don’t hold moisture.”

Greg Stubbs - Head Football Coach - Tennessee High School

“I have been buying Z-Cool shoulder pads for the past five years. Here at Boise State, our players love the protection, light weight and added mobility the Z-Cool shoulder pads provide.”

Dale Holste - Head Equipment Manager, Boise State University

“Gear Shoulder Pads have made a huge impact in my program. I have much fewer injuries and far less complaints when my players are wearing these pads. Gear Pads have become the overwhelming favorite among my players.”

Mike Kohl - Head Football Coach, Bradley Bourbonnais High School

“This year we purchased the Gear shoulder pads. After taking time to research the pads I found them true to what they promote. As an athletic trainer I am first trying to protect our athletes from injuries in football. I truly like the way the shoulder pad fits, especially with the adjustable padding at the AC joint, allowing me to custom fit each player based on their shoulder girth. The moisture management system with the material built into the pads has helped the athletes stay cool along with helping prevent issues related to moisture left in the shoulder pads. This has drastically cut down problems with Staph and other bacterial germ diseases. Our quarterback loves the fit and mobility he has with the Gear Z-Cool QB pads. I like the quality protection these pads provide and will continue to look at Gear pads for future football seasons.”

Kris Knapp - Head Trainer/Equipment Manager - Ontario High School



X7-SKILL

- Light weight low profile flat pad design
- Shorter arch design with smaller footprint provides greater mobility while still offering best in class protection
- Built-in back plate
- Recommended for QB/WR/DB or similar Skill positions

1454175 Specify Size (SM - XL) **\$199.99** EA ★

SIZE	SM	MD	LG	XL
SHOULDER	16"-17"	17"-18"	18"-19"	19"-20"
CHEST	36"-38"	38"-40"	40"-42"	42"-44"





X-15 MULTI-POSITION

- Flat pad design provides optimum combination of protection and mobility for multiple positions
- Short front arch for extended range of motion with extended rear arch for added protection
- Narrower arch design for greater hands up movement
- Dual Biothane and Elastic belt system for secure fit
- Multi-Position pad recommended for RB/DB/TE/DE or similar positions requiring mobility and added protection

1454181 Specify Size (SM - 2XL) **\$199.99** EA ★

SIZE	SM	MD	LG	XL	2XL
SHOULDER	16"-17"	17"-18"	18"-19"	19"-20"	20"-21"
CHEST	36"-38"	38"-40"	40"-42"	42"-44"	44"-46"



X55-OL/DL

- Most protective X3 model offering greater coverage for blocking and tackling
- Narrower arch design for greater hands up movement
- Specially designed for larger players such as OL/DL/DE/TE positions

1454187 Specify Size (MD - 3XL) **\$199.99** EA ★

SIZE	MD	LG	XL	2XL	3XL
SHOULDER	17"-18"	18"-19"	19"-20"	20"-21"	21"-22"
CHEST	38"-40"	40"-42"	42"-44"	44"-46"	46"-48"

YOUTH



Z-COOL 2.0

JV/YOUTH

- NEW Carbon Fiber look for an intimidating presence
- Z-Cool® Moisture Transfer System Patent #7,168,104
- Moisture Wicking Anti-Microbial Interior Fabric
- AC Notch-Out With Cradle Pad
- Adjustable Clavicle Pad System with Fixed Cap Pad
- Z-Cool® Plastic Inner Arch Design Patent #7,168,104
- 1.5" Belts With Non-Cut Buckles, Patent #D543,488
- PRO-LOC™ Epaulet Design Rigid Plastic Sternum Protection

1454455 Specify Size (XS - 3XL) \$149.99 EA ★

SIZE	XSM	SM	MD	LG	XL	2XL	3XL
SHOULDER	12"-13"	13"-14"	14"-15"	15"-16"	16"-17"	17"-18"	18"-19"
WEIGHT	30-45 lbs.	40-60 lbs.	60-80 lbs.	75-100 lbs.	95-120 lbs.	115-140 lbs.	135-160 lbs.



JV/YOUTH



- For Youth, Middle School or JV
- Perforated arch foam system allows for quick drying
- Low profile flat pad construction with vented arch plastic
- Rigid plastic sternum protection
- AC joint notch-out with cradle pads
- 1.25" Belts with non-cut buckles

1454463 Specify Size (XS - 3XL) \$99.99 EA ★

SIZE	XSM	SM	MD	LG	XL	2XL	3XL
SHOULDER	12"-13"	13"-14"	14"-15"	15"-16"	16"-17"	17"-18"	18"-19"
WEIGHT	30-45 lbs.	40-60 lbs.	60-80 lbs.	75-100 lbs.	95-120 lbs.	115-140 lbs.	135-160 lbs.



BACK PLATE

- Air flow foam evaporative cooling system
- Lightweight reinforced polycarbonate protective plate
- NEW screw and T-nut attachment system fits all models of GEAR Pro-Tec shoulder pads as well as most competitors (does not fit Z-Cool OL/DL Pro Select, DL/TE/DE and X2 Air X-16 pads)

1317350	Varsity	\$34. ⁹⁹ EA ★
1312379	Youth	\$29. ⁹⁹ EA ★



RIB COMBO PROTECTOR

- Air flow foam evaporative cooling system
- Lightweight reinforced polycarbonate protective plate
- New Screw & T-Nut attachment system designed to fit all models of Gear Pro-Tec shoulder pads
- Hook and loop front closure

1312584	S (34"-38")	\$59. ⁹⁹ EA ★
1312577	M (40"-44")	\$59. ⁹⁹ EA ★
1312560	L (46"+)	\$59. ⁹⁹ EA ★
1317336	Youth M (26"-30")	\$54. ⁹⁹ EA ★
1317343	Youth L (30"-34")	\$54. ⁹⁹ EA ★



SHOULDER PAD RESTRAINT CUFF

- Helps minimize hyperextensions
- Slash proof biothane straps
- Air flow technology for cooling
- Universal fit for any belt system shoulder pad

1456008	S/M	\$89. ⁹⁹ EA ★
1456009	L/XL	\$89. ⁹⁹ EA ★



EQUIPMENT BAG

- 32" x 13" x 16"
- Separate compartments for shoulder pads and helmet

1312836		\$44. ⁹⁹ EA ★
----------------	--	--------------------------



NECK ROLL

- One size fits all
- Foam filled nylon fabric
- Attaches with screws and t-nuts

1317312	Varsity	\$34. ⁹⁹ EA ★
1317329	Youth	\$24. ⁹⁹ EA ★



WALK THRU AND INJURY VEST

- Air flow foam evaporative cooling system
- Lightweight protection

1317299	S (36"-38")	\$69. ⁹⁹ EA ★
1317305	M (38"-42")	\$69. ⁹⁹ EA ★
1312621	L (44"-46")	\$69. ⁹⁹ EA ★
1312645	XL (46"-48")	\$69. ⁹⁹ EA ★
1312591	2XL (48"-52")	\$69. ⁹⁹ EA ★
1312607	3XL (52"-56")	\$69. ⁹⁹ EA ★



3" ROUND KNEE PADS

- Air flow and evaporative cooling system
- Sold in pairs

1388428	3" ROUND	\$7. ⁹⁹ PR ★
----------------	----------	-------------------------



Z-COOL KNEE PADS

- Air flow and evaporative cooling system
- Sold in pairs

1312522	XS - 4"L x 3"W	\$11. ⁹⁹ PR ★
1312515	S - 5"L x 4"W	\$11. ⁹⁹ PR ★
1312508	M - 5.5"L x 4.5"W	\$11. ⁹⁹ PR ★

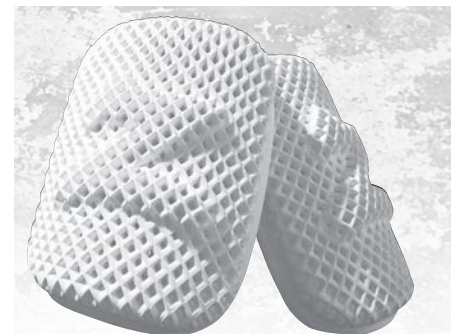

Z-COOL® THIGH GUARDS

- Air flow and evaporative cooling system
- Sold in pairs

1312706	S	7"L x 5"W	\$19. ⁹⁹ PR ★
1312690	M	8"L x 6"W	\$22. ⁹⁹ PR ★



4-STACK SHOULDER PAD RACK

- Base with rectangular channel design increases strength and stability
- 4 heavy duty swivel casters for easy movement
- Holds up to 60-80 pads (Depending on pad size)

1378670 68"H x 24"W x 60"L - 65 lbs **\$649⁹⁹** EA ★



COMBO HELMET/SHOULDER PAD RACK

- Rigid base design increases strength and stability
- 4 heavy duty swivel casters for easy movement
- Holds up to 30 Shoulder Pads and 32 Helmets

1378672 68"H x 24"W x 30"L - 55 lbs. **\$629⁹⁹** EA ★



STORAGE BAG

FOOTBALL HELMET CART

- Constructed of 1" O.D. black powder coated steel tubing
- Heavy duty urethane swivel wheels - 2 with brakes
- 5 welded shelves make for easy assembly
- Will hold 50 football helmets with masks (can also be used for lacrosse helmets, batting helmets, basketball, volleyballs, etc.)
- Fits through standard doorways
- 64"H x 24"W x 61"L - 61 lbs.

1378673 **\$629⁹⁹** EA ★
SNBCNET Storage Bag - 32" x 36" (Specify Color) **\$17⁹⁹** EA ★



SHOULDER PAD HANGER RACK

- Constructed of 1.5" black powder coated steel tube
- 4" heavy duty urethane swivel casters
- Holds up to 28 shoulder pads, any size
- Fits through standard doorways
- Allows pads to keep their shape and air dry

1453172 60" L x 27.5" W x 73.5" H - 71 lbs. **\$399⁹⁹** EA ★

SCRIMMAGE HELMET COVERS (12-PACK)

ONE SIZE FITS ALL

- 1/2" gripper elastic bottom to prevent slippage
- 90% Cotton/10% Lycra

Color Options: **Black, Gold, Orange, Royal, Scarlet.**

1071948

\$69⁹⁹ DZN



ULTRA-LITE KNEE PADS

- High density ultra-lite foam

FBULKPA	8.25" Adult	\$11 ⁹⁹ PR ★
FBULKPI	7.5" Intermediate	\$11 ⁹⁹ PR ★
FBULKPY	7" Youth	\$11 ⁹⁹ PR ★



ULTRA-LITE THIGH PADS

- High density ultra-lite foam with plastic impact plate

FBULTPA	9" Adult	\$24 ⁹⁹ PR ★
FBULTPI	8" Intermediate	\$24 ⁹⁹ PR ★
FBULTPY	7" Youth	\$23 ⁹⁹ PR ★



ULTRA LITE 3-PIECE HIP PADS

- High density ultra-lite foam reinforced with plastic

FBULHP3A	Adult	\$25 ⁹⁹ SET ★
FBULHP3I	Intermediate	\$23 ⁹⁹ SET ★
FBULHP3Y	Youth	\$14 ⁹⁹ SET ★



ULTRA LITE TAIL PADS

- High Density ultra-lite foam reinforced with plastic (7"L)

FBTPS	Slotted	\$7 ⁹⁹ EA ★
FBTPSNAP	Snaps	\$7 ⁴⁹ EA ★



YOUTH 7PC ULTRA LITE PAD SET

- High density ultra-lite foam reinforced with plastic

FBUL7YSS	Sliding Snaps	\$39 ⁹⁹ SET ★
FBUL7YSLP	Slotted	\$36 ⁹⁹ SET ★



NEW NEON COLORS!

LIGHTWEIGHT SCRIMMAGE VESTS

- Polyester mesh vest
- Reinforced neck and armholes
- Elastic waistband

Color Options: **Black, Gold, Kelly, Neon Green, Neon Orange, Neon Yellow, Orange, Purple, Royal, Scarlet.**

C46Y	K thru 3rd Grade	\$6 ⁹⁹ EA ★
C46	4th-6th Grade, Middle School & Up	\$7 ⁹⁹ EA ★
C47N	Adult (# 1-12) GO,KE,OR,PU,RQ,SC,BK only	\$94 ⁹⁹ DZN ★



REVERSIBLE SCRIMMAGE VESTS

- Polyester mesh construction
- Reversible jerseys with elastic bottom

Color Options: **Dark Green/Gold, Orange/Gold, Red/Black, Royal/Gold, Royal/Red, Silver/Black.**

126271I	Adult	\$99 ⁹⁹ DZN ★
1262773	Youth	\$99 ⁹⁹ DZN ★



HEAVY DUTY VINYL MESH PRACTICE VEST

- Wide elastic Velcro® straps
- Heavy duty vinyl mesh
- Slips over helmet and shoulder pads easily without assistance
- Light and breathable but very durable
- 17"W x 20"L

Color Options: **Black, Blue, Gold, Grey, Kelly Green, Orange, Red, White.**

1398268	Specify Color (12/Pack)	\$349 ⁹⁹ DZN
----------------	-------------------------	-------------------------

HEAVY DUTY SCRIMMAGE VEST

- Polyester Porthole mesh, elastic waist, large neck and arm holes.
- Sewn with no shoulder seams to reduce ripping and extend life.

Color Options: **Black, Gold, Kelly, Purple, Royal, Scarlet.**

C48	\$12 ⁹⁹ EA ★
------------	-------------------------



FLAG-A-TAG®



SONIC FLAG BELTS

- Featuring Flag-A-Tag's patented release system
 - Sonic belts emit an audible "pop" to signal the play is dead
 - Built for institutional use
 - Flag size: 2"W x 17-1/4"L
 - Sold by dozen per size/color
- Color Options: **Gold, Kelly, Royal, Scarlet, White.**

8674223 42" FLAG BELTS \$119⁹⁹ DZN ★
8675223 52" FLAG BELTS \$119⁹⁹ DZN ★

SOCKET & PLUNGER "POPS" WHEN PULLED FROM SOCKET



SOCKET ANGLES BELT AWAY FROM PLAYER



PROGRAM KIT

- Designed to outfit two teams of twelve players
- Includes 24 belts with flags, 2 storage rings, and 1 flag football rule book
- Select either 42" or 52" belts
- Choose two colors: Gold, Kelly, Royal, Scarlet or White

8671000 \$299⁹⁹ SET ★

JUNIOR FLAG FOOTBALL PACK

All the equipment needed for a game!

Package Includes:

- 24 - 42" Flag belts with flags (12 each Red and Yellow)
- 24 - C46 Lightweight Adult mesh vests (12 each Red and Yellow)
- 1- Junior size rubber football
- 8 - Game cones (12")
- 2- Official's pinnies
- 1- Stopwatch
- 2 - Flag belt storage rings
- 1 - USFTL rule book and officials manual
- 1- Wheeled deluxe storage/transport bag

1238037 64 Pieces \$599⁹⁹ PACK ★



FLAG-A-TAG® STORAGE RINGS

- Provides easy storage for all types of flag belts
- Holds 12 - 18 belts

8671010 \$19⁹⁹ EA ★



SONIC CONVERSION PACKAGE

- Converts a 2 flag belt into a triple flag belt
 - Includes 12 sockets, 12 Stems and 12 flags
- Color Options: **Gold, Kelly, Royal, Scarlet, White.**

8670023 \$54⁹⁹ DZN ★

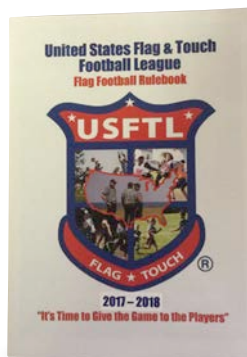

USFTL RULE BOOK AND OFFICIALS MANUAL

- Standard rule book for all USFTL leagues
- Rule Highlights include: Definitions, Official's Manual, Games, Playing Fields, Equipment, Periods, Time factors, Overtime, Substitutions, Scoring, Conduct, Penalties, Ranking System ...and much more

86703XXX \$24⁹⁹ EA ★

FLAG FOOTBALL BELTS

Three flags permanently sewn onto the web belt. Entire belt comes off - no parts to lose! Belts are washable.

- Vinyl coated polyester flag will not tear
- Flag size: 2 1/4"W x 14 1/2"L
- Heavy duty polyethylene "gator clip"
- Adjusting slide for sizing
- Belt clips are color coded to indicate size
- Specify size when ordering:
- SMALL: 22" - 32" RED Belt Clip
- MEDIUM: 28" - 38" YELLOW Belt Clip
- LARGE: 32" - 44" BLUE Belt Clip
- X-LRG: 38" - 52" GREEN Belt Clip

1149487	Red Flags - Specify Size	\$6 ⁹⁹ EA ★
1149524	Yellow Flags - Specify Size	\$6 ⁹⁹ EA ★
1149562	Blue Flags - Specify Size	\$6 ⁹⁹ EA ★
1149609	Green Flags - Specify Size	\$6 ⁹⁹ EA ★

ADJUSTABLE FLAG BELTS

- Each belt includes 2 flags
- Flags attached with hook-and-loop belt attachment that slide over belt
- Flag size: 2"W x 16 1/4"L
- Steel D-ring belt loops for sizing
- One size fits most - belt length 42"

Color Options: **Blue, Red, Yellow.**

MSFB	Belts With Flags	\$4 ⁹⁹ EA ★
1234749	Belts Only	\$9 ⁹⁹ SET OF 6 ★
MSFLAGS	Flags w/Belt Attachment Only	\$8 ⁹⁹ SET OF 6 ★

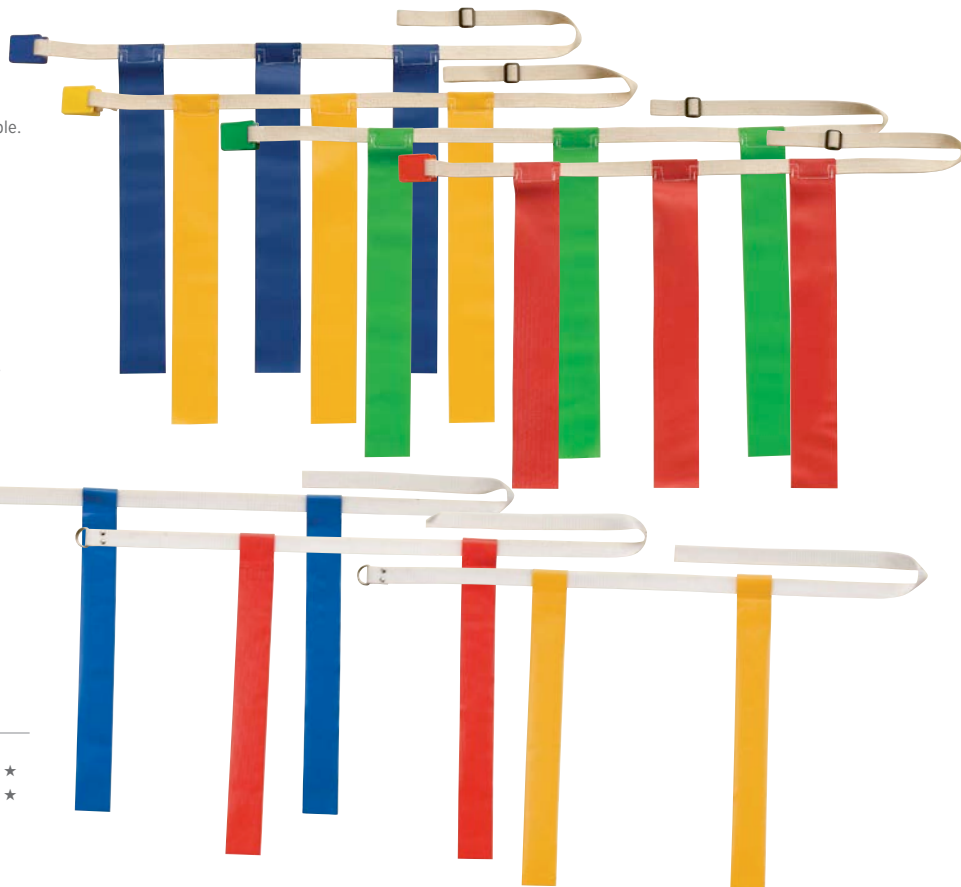

TRIPLE THREAT DOWN BOX & SCOREBOARD

- Combines the features of a down box and scoreboard into a single unit
- Score can be shown on both sides of the down indicator
- Made of strong light weight PVC material
- Easily disassembles for storage
- 7'H when assembled
- Includes plastic numbers, 2 dry erase score sheets with markers and pole



1196160	\$269 ⁹⁹ EA ★
----------------	--------------------------



STACKABLE SIDELINE MARKERS

- 13"H, 3 sided pyramid shaped markers
- Made of tough, flexible vinyl
- Stackable for easy storage
- 5-piece set includes: 2-G's, 2-20's, 1-40
- 11-piece set includes: 2-G's, 2/10's, 2/20's, 2/30's, 2/40's, 1/50

1245127	5 Piece Set for Flag Football	\$279 ⁹⁹ SET ★
1245134	11 Piece Set	\$499 ⁹⁹ SET ★



DAY/NIGHT SIDELINE MARKERS

- Soft, crushable foam core inside durable vinyl cover
- Folding design for flat storage
- Hook and loop fasteners with weighted bottom to maintain upright position
- 15"H X 15"W with 13"H numbers
- Includes 2-G's, 2-20's and 1-40

1249354	5 Piece Set for Flag Football	\$279 ⁹⁹ SET ★
----------------	-------------------------------	---------------------------

OFFICIAL'S PENALTY FLAG

- Regulation size 15" x 15" nylon with a weighted center
- Available in yellow only



FBREFFLG	\$11 ⁹⁹ EA ★
-----------------	-------------------------



BALL SPOTTER

- 3 1/2" diameter pliable rubber disc

1240245	Orange	\$15 ⁹⁹ EA
1240252	Yellow	\$15 ⁹⁹ EA



PYLONS

- Bright, fluorescent orange
- Safe foam filled vinyl
- 18"H x 4"W x 4"D
- Set of 4

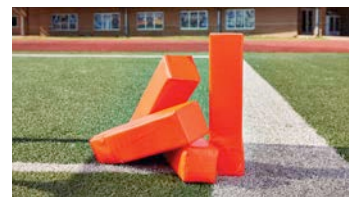

MSWPYLON	Weighted Anchorless	\$79 ⁹⁹ SET OF 4 ★
-----------------	---------------------	-------------------------------



PORTABLE COOLING SYSTEM

- Frame constructed of heavy wall powder coated steel
- Cools temperature in front of fan 10-20 degrees; up to 50' away
- Transports easily on two 10" "No Flat" wheels
- Includes: 50 PSI pump, 24" fan, 5 brass misting heads, 20 gallon tank (provides approximately 7 hrs. of operation)
- Dimensions: 68"H x 28"W x 31"D - 135 lbs. (empty)
- Requires 115V electrical outlet
- Warranty: Fan - 2 Years; Pump - 1 Year; Parts - 1 Year; Frame - 5 Years

1240405

\$2,399⁹⁹ EA ★



HYDRATION PACKAGES



GAME DAY HYDRATION PACKAGE

- The perfect solution for keeping athletes cool, hydrated and ready for peak performance on game day
- Package includes: 2 - Portable Mister Cooling Systems (SPCMIST) and 1 - Power Tanker with Cart (SPCPT)
- Water bottles sold separately

1371360

\$4,999⁹⁹ PACK

\$5260 RETAIL VALUE



PRACTICE HYDRATION PACKAGE

- Hydrate more players faster, so more time can be spent practicing, with 20 total drinking stations
- Package includes: 2 - Powered Team Drinkers (SPCPTD) and 1 - Drinking Station (SPCDS)

1371361

\$2,899⁹⁹ PACK

\$2800 RETAIL VALUE



SAVE 30%

SAVE 25%



DRINKING STATION WITH FILTER

- Galvanized steel tubing frame with removable legs for easy transport and storage
- Drinking tube is made of non-corrosive PVC
- In-line filter for cleaner fresher water
- Includes 8 drinking stations with shut-off nozzles
- Connects to a standard water hose (not included)
- Dimensions: 43"H x 53"L - 25 lbs

1453185	Complete Unit	\$519⁹⁹ EA ★
1453180	Replacement Water Filter	\$59⁹⁹ EA ★
ZX3920094	Flexible Hose Connection	\$9⁹⁹ EA ★

REPLACEMENT PARTS		
SPCHOSE	Coiled Hose and Shut Off	\$46⁹⁹ EA ★
SPCWAND	Shut Off Assembly	\$25⁹⁹ EA ★
SPCBAT	Replacement Battery	\$99⁹⁹ EA ★
ZX3930034	Replacement Battery Charger	\$129⁹⁹ EA ★
SPC16	Sanitizing Tablets (150/Bottle)	\$11⁹⁹ BOT

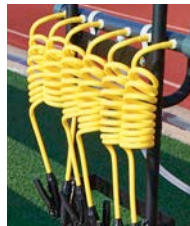

WATER BOTTLES SOLD SEPARATELY SEE PAGE 132



POWER TANKER WITH CART

- NEW & IMPROVED Cart design with translucent blue tank
- Constructed of steel tube frame with aluminum bottom deck and top utility shelf (water bottles not included)
- Drinking tube constructed of non-corrosive PVC
- Rides and steers smoothly on four heavy duty wheels with 10" pneumatic tires
- Front wheels swivel for easy maneuverability
- Equipped with optional use towing attachment
- Includes 8 coiled drinking hoses, sanitizing tablets, 35 gallon FDA, NSF approved tank
- Rechargeable 12V / 12amp Power Pack provides 8 hours of use
- Dimensions: 43"L x 20"W x 54"H - 140 lbs. (empty)

1378677 Complete Unit **\$2,299⁹⁹** EA ★



PORTABLE WATER CHILLER

- Cart constructed of heavy wall powder coated steel
- Add ice to the cooler, attach water hose (not included) and the copper coil inside the tank cools drinking water as it passes through to the drinking stations
- Transports easily on two 10" "No Flat" wheels
- Includes: 6 retractable coil drinking hoses w/ quick shut-off nozzles and 10 gallon cooler
- Dimensions: 50"H x 21"W x 25"D - 46 lbs.

1240429 **\$1,499⁹⁹** EA ★



POWERED TEAM DRINKER

- Cart constructed of heavy wall powder coated steel
- Drinking tube constructed of non-corrosive PVC
- Transports easily on two 10" "No Flat" wheels
- Includes: 6 Retractable coil drinking hoses with quick shut-off nozzles
- 20 gallon FDA, NSF approved translucent blue tank with sanitizing tablets
- Rechargeable 12V/12amp power pack provides 8 hours of use
- Dimensions: 50"H x 21"W x 25"D - 135 lbs. (empty)

1240412 Complete Unit **\$1,699⁹⁹** EA ★



PRACTICE LACROSSE GOAL

- Constructed of 13-gauge, orange powder coated, 1 1/2" O.D. steel tubing
- Includes 4mm knotless nylon net, lacing cord and light weight ground anchors

LACPRAGL 50 lbs. **\$229⁹⁹** EA ★

GOAL NETS

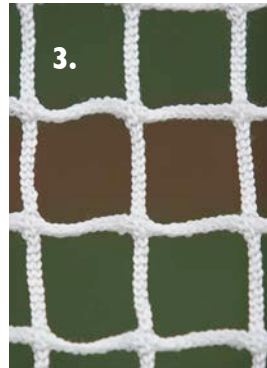
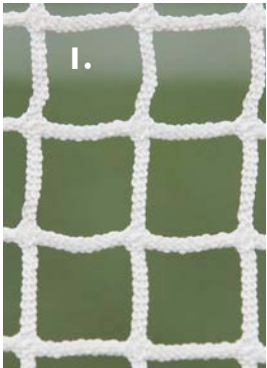

1. PROFESSIONAL LACROSSE NET

- White, 6mm knotless nylon lacrosse net, includes lacing cord

1382863 **\$299⁹⁹** EA ★

2. CHAMPIONSHIP LACROSSE NET

- Black, 5mm knotless nylon lacrosse net, includes lacing cord

1382861 **\$199⁹⁹** EA ★

3. PRACTICE LACROSSE NET

- White, 4mm knotless nylon lacrosse net, includes lacing cord

1272925 **\$149⁹⁹** EA ★



- Mouthguards should be used in contact and non-contact sports to reduce the risk of concussion and mouth related injuries
- Top quality Dental Vinyl for greater strength, comfort, ease of speech and breathing
- Adult size is for ages 11 and up
- 30-second custom fit
- Youth Color Options w/Strap: Black, Gold, Scarlet, Royal
- Adult Color Options w/Strap: Black, Gold, Scarlet, Royal, Green, Maroon, Navy, Orange, Purple, Clear
- Adult Color Options Strapless: Black, Gold, Scarlet, Royal, Green, Maroon, Navy, Purple

MSMOUT Adult w/ Strap - Specify Color **\$21⁹⁹** PACK OF 25
1179620 Youth w/Strap - Specify Color **\$20⁹⁹** PACK OF 25
1403270 Adult Strapless - Specify Color **\$2⁹⁹** EACH



SHOCK DOCTOR[®]
GEL MAX ADULT CONVERTIBLE MOUTHGUARD

- Gel Fit liner custom molds to teeth for tight, comfortable fit
- Exoskeletal Shock Frame
- Triple layer design with integrated breathing channel
- Convertible tether allows for use with or without a strap
- Adult Team packs of 48 sold in bulk poly bag
- Color Options: Black, Blue/Black

1384275 Specify Color **\$15⁹⁹** EA

GAME/PRACTICE GOALS



PRACTICE BOX LACROSSE GOAL

- 4'H x 4'W x 5'D
- Constructed of sturdy 1.5" diameter steel tube with orange powder coat finish
- Entire Goal is equipped with welded Lacing Rods
- Includes 4mm knotless nylon Net and Ground Anchor Stakes

1453175 \$229⁹⁹ EA ★
1453176 \$149⁹⁹ EA ★

4mm Replacement Box Net



OFFICIAL LACROSSE GOAL AND NET

- Constructed of 13-gauge, orange powder coated, 1.9" O.D. steel tubing and 3"W flat steel ground supports
- Includes 6mm knotless nylon net, lacing cord and heavy-duty ground anchors

LACOFFGL 125 lbs. Per Goal \$1,299⁹⁹ PR ★



MEN'S LACROSSE SCOREBOOK

- Spiral bound, 12 1/2"W x 12"H
- Comprehensive scorebook and record keeper
- Contains home and visitor scoring for 31 games

1377127 \$13⁹⁹ EA



WOMEN'S LACROSSE SCOREBOOK

- Spiral bound, 11"W x 9 1/2"H
- Comprehensive scorebook and record keeper
- Contains home and visitor scoring for 29 games

1377128 \$14⁹⁹ EA





MEN'S LACROSSE COACH'S BOARD

- Full field and half field writing surfaces front and rear
- Includes premium dry erase marker
- 8"W x 15 1/2"L

1388111 \$29⁹⁹ EA ★



WOMEN'S LACROSSE COACH'S BOARD

- Full field and half field writing surfaces front and rear
- Includes premium dry erase marker
- 8"W x 15 1/2"L

1388112 \$29⁹⁹ EA ★

BALLS

LACROSSE BALLS

- Official NOCSAE/SEI stamped approved game balls meet NCAA and NFHS specifications
 - Availability in Men's(White) and Women's(Yellow)
 - Soft white practice ball is not NOCSAE approved
 - Brand of balls may vary
- 30 Day Limited Warranty**

LXB	White	\$29 ⁹⁹ DZN
LXBY	Yellow	\$29 ⁹⁹ DZN
LXB0	Orange	\$29 ⁹⁹ DZN
1725UPB	Soft White Practice	\$21 ⁹⁹ DZN
1380843	Bucket- 5 DZN White	\$159 ⁹⁹ EA ★





PORTABLE BARRIER NET

- Multi-sport portable barrier net
- Includes free carry bag with wheels

1344097 12 1/2'H x 21 1/2'W - 56 lbs. **\$589⁹⁹** EA



PORTABLE LACROSSE GOAL

- Full size portable lacrosse goal
- Includes free carry bag with wheels

1344073 7'H x 7'W x 6'D - 25 lbs. **\$369⁹⁹** EA



PORTABLE LACROSSE GOAL CREASE (MEN'S)

- Portable official 18' men's size lacrosse crease
- Includes internal weights for use on turf fields and grounds stakes for use on grass fields
- Includes free carry bag

1344080 18' Diameter - 9 lbs. **\$159⁹⁹** EA



BOWNET

BOX LACROSSE NET

- Goal is constructed from a rigid steel frame
- Non-marking rubber feet to prevent damage to floors
- Includes lacrosse goal netting with nylon cover, ground frame, BOW-poles, and carrying bag for easy portability and storage

1453020 **\$349⁹⁹** EA



BOWNET

HALO BARRIER NET

- Fits around any standard full size lacrosse goal
- BOW poles and powder coated steel frame have non-marking rubber feet
- Includes halo barrier netting, ground frame, stakes, BOW poles, and carrying bag for easy portability and storage

1453021 12' x 9' **\$399⁹⁹** EA



BOWNET

WOMEN'S LACROSSE ARC

- Allows you to set up the full goal markings, indoor or outdoors
- Can be staked down on grass or weighted down for the gym floor or turf
- Weight pockets every 4 meters around perimeter act as hash marks
- Goal and crease sold separately

1388426 **\$569⁹⁹** EA

PORTABLE LACROSSE GOAL CREASE (WOMEN'S)

- Portable official 17' women's size lacrosse crease
- Sets up in seconds
- Includes internal weights for use on turf and ground stakes for use on grass fields
- Goal and arc sold separately
- Includes free carry bag

1388427 17' Diameter - 8 lbs. **\$159⁹⁹** EA

RAGE CAGE

PORTABLE LACROSSE GOALS

- 6'H x 6'W x 7'D official size goal with 4mm net (Club-XT) or 3mm net (B100-XT)
- Folded size: 48"H x 47"W x 13"D
- 1.75" O.D. (Club-XT), 1.5" O.D. (B100-XT), 16 gauge orange powder-coated steel tubing
- Pre-strung net with full perimeter hem
- Carrying strap included
- Improved one-time assembly required



CLUB SX

1369693 Club-V4 **\$425⁹⁹** EA



B100 SX

1375528 B100-V4 **\$299⁹⁹** EA



PORTABLE BACKSTOP SYSTEM

- All-aluminum construction
- 3" round upright poles (4)
- 2" round bottom bars with net attachment to prevent ball from passing under the net
- Each 20' section can be angled to accommodate curved perimeters
- Closed bottom design is turf friendly
- Includes: 2mm 1-3/4" mesh net, 16 heavy duty Anchor Bags, Kwik Lock Net Clips
- 15'H x 60'L

1379269 Complete Set - 215 lbs **\$5,499⁹⁹** EA EA
 1379270 Replacement Net **\$679⁹⁹** EA



GOAL TARGET

- Available in two styles for two levels of challenge
- Improves shooting accuracy
- Made of durable polypropylene with reinforced edges
- Includes easy-to-attach bungee fasteners

1334555 Advanced **\$129⁹⁹** EA

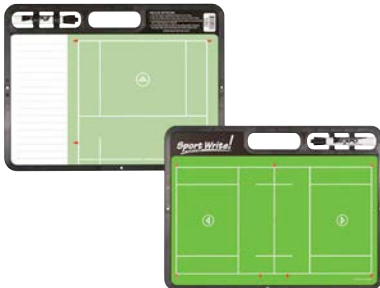

PRO LACROSSE DRY-ERASE BOARD

- Large format enables entire team to see play
- 2 writing surfaces
- Includes premium dry erase marker
- 12 1/2"H x 16 1/2"W

1366487 Men's **\$39⁹⁹** EA
 1371672 Women's **\$39⁹⁹** EA



ALL PURPOSE BACKSTOP SYSTEM

- Backstop system measures 21'H x 65'W
- Constructed with (4ea) 3.5" galvanized steel poles
- Choice of 3mm 4" mesh or 1.75" mesh (275 lb. breaking strength)
- Easy on and off pulley system and (4ea) galvanized steel ground sleeves
- Weight: 360 lbs.

1071435 System with 1 3/4" Netting **\$4,799⁹⁹** EA EA
 1072230 Replacement Net - 1 3/4" Mesh **\$929⁹⁹** EA

BALL BOUNDARY SYSTEM

- Complete 12' high system with poles and netting
- Posts are constructed of 2 3/8"D x 3/16" wall aluminum tubing
- Ground Sleeves are aluminum with rubber caps
- Top and Bottom of Net is supported by nylon coated galvanized cable
- 1 3/4" 3mm braided knotless EHT black net
- Posts are spaced 20' apart

BBS12A 12'H System - Complete **\$33⁹⁹** FT FT
 BBSNET12 12'H Replacement Net **\$12⁹⁹** LF LF

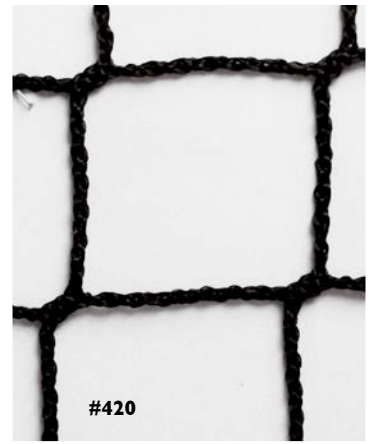

PRE-CUT BOUNDARY/PROTECTIVE NETTING

- 1-3/4" mesh, weather treated Varsity (#420) EHT black knotless netting
- Heavy overlock stitched rope border

1236576 Net Size 10' x 30' **\$299⁹⁹** EA EA
 1236583 Net Size 12' x 50' **\$499⁹⁹** EA EA
 1236590 Net Size 14' x 50' **\$699⁹⁹** EA EA
 1236606 Net Size 14' x 100' **\$1,299⁹⁹** EA EA



PASS BACK TARGET

- 7'H x 4'W steel frame
- 4'H x 3'W rebound surface area
- Frame adjusts for varied rebound angles
- Add the STX Pass Master Cover and improve passing fundamentals and accuracy

1377188 1) BSN Frame and Solid Target **\$549⁹⁹** EA EA
 1371638 2) STX Pass Master Cover Only **\$64⁹⁹** EA



BSN SPORTS ATHLETIC TAPE

- 100% cotton backcloth, zinc oxide white trainer's tape
- High tensile strength with excellent tackiness
- 1 1/2" x 15 yard rolls

MU130605B 32 rolls per case \$99.99 CASE



BSN SPORTS PRE-WRAP

- Pre-taping foam underwrap that protects athlete's skin from chafing and irritation
- Each roll is 2.75" x 30 yards long
- 48 rolls per case

MU130597 \$89.99 CASE



750 ATHLETIC TAPE

- Zinc Oxide tape offers maximum tensile strength and comfortability
- Latex free adhesive
- Computer calibrated unwind for consistency and performance roll to roll
- Roll: 1.5" x 15 yd
- 32 rolls per case

2190XXXX Case of 32 \$159.99 PACK 32 ROLLS



M-WRAP

- Pre-taping foam underwrap
- Helps protect skin from tape chafing
- Can be used to keep hair out of face, hold pads and socks in place and as a protective wrap inside athletic footwear
- 48 rolls per case
- Specify color

Color Options: **Black, Natural.**

MU1307 2.75" x 30 yards per roll \$118.99 CASE



BANDAGE SCISSORS

- Flat-tipped bottom blade slips safely under tape and bandages
- Stainless steel, 7.25" blade

1078695 \$28.99 EA



MTAPE

- 100% cotton backcloth, zinc oxide white trainer's tape
- High tensile strength with excellent tackiness
- Easy unwind to core
- 1 1/2" x 15 yard rolls

MU130105 32 rolls per case \$144.99 CASE



TAPE WRAP PREMIUM

- Excellent alternative to pre-wraps, compression wraps, wound care and fixation bandages.
- Cohesive, breathable, sweat-resistant, high tensile, lightweight and easy tearing.
- 2" x 6 yards is 24 rolls per case
- 3" x 6 yards is 16 rolls per case

Color Options: **White, Black.**

1348606 2" - White Color Only \$74.99 EA

1348613 3" - Specify Color \$89.99 EA



Johnson & Johnson 5188 ATHLETIC TAPE

- High-quality, breathable porous athletic tape protects joints from sprains and injury
- Provides support to speed recovery after injury
- Packaged in SPEED PACK®
- Each roll is 1 1/2" x 15 yds
- 32 rolls per case

1420363 Case of 32 \$144.99 CASE



TEAR-LIGHT TAPE

- Superior adhesive
- Excellent comfort
- Ideal for securing lateral knee braces as well as compression wrap or fixation bandages for padding and cold packs
- Available in 2" or 3" wide rolls

MU130622 2" x 5 yd - 24 rolls/case \$99.99 CASE

MU130623 3" x 5 yd - 16 rolls/case \$109.99 CASE



SHARK TAPE CUTTER

- Cuts through tape and bandage material with ease.
- Made of the highest quality Valox resin, fiberglass-reinforced for durability.
- 8.25" L

1082517 \$27.99 EA

COACH'S CHOICE



INSTANT COLD PACK

- Convenient and ready whenever you need it
- No refrigeration needed - activates instantly
- Ideal for sports injuries or first aid

MU030102 6" x 9" \$41.99 PACK



REUSABLE HOT/COLD PACKS

- Soft gel refrigerates for cold therapy and microwaves for heat therapy
- A versatile, non-toxic pack ideal for applying cold therapy or heat therapy

MU030104 4.75" x 6" \$44.99 PACK
MU030105 6" x 9" \$54.99 PACK



PERSONAL FIRST AID KIT

- Plastic case with waterproof gasket
- Kit Contents: (10) 3/4" x 3" Adhesive Strips, (1) XL Adhesive Strip, (1), Fingertip Bandage, (1) Knuckle Bandage, (1) 2" Sterile Conforming Bandage, (2) 3" x 3" Gauze Pads, (2) Latex Gloves, (1) 1/2" x 5yd Adhesive Tape, (2) 1/32 oz. Triple Antibiotic, (2) 1/32 oz. First Aid Cream, (6) Antiseptic Towelette, (1) Instant Cold Pack, (1) Instant Sting Relief, (1) PAWS Antimicrobial Wipe

1202090 6.5" x 5" x 2" \$27.99 EA



25 PERSON FIRST AID KIT

- 9" x 6 5/16" x 2 3/8" Plastic Case with Waterproof Gasket and Wall Mount/Handle
- Kit Contents: (2) 1/2" x 5yd Adhesive Tape, (1) Instant Cold Pack, (10) Antiseptic Towelettes, (2 pair) Disposable Gloves, (10) 1/32 oz. First Aid Cream, (100) 1" x 3" Adhesive Strips, (1) 5" x 9" Combine Pad, (6) 3" x 3" Gauze Pads, (2) Oval Eye Pads, (1) Triangular Bandage, (1) 2" x 4yd Conforming Bandage, Scissors and Forceps

1202106 OSHA Compliant \$49.99 EA



50 PERSON FIRST AID KIT

- 9" x 9" x 2 3/8" Plastic Case with Waterproof Gasket and Wall Mount/Handle
- Kit Contents: (2) 1/2" x 5yd Adhesive Tape, (2) Instant Cold Pack, (10) Antiseptic Towelettes, (2 pair) Disposable Gloves, (10) 1/32oz First Aid Cream, (8) Fingertip Bandages, (8) Knuckle Bandages, (2) Eye Wash Bottles, (100) 1" x 3" Adhesive Strips, (2) XL Adhesive Strips, (3) Insect Sting Relief, (1) 5" x 9" Combine Pad, (12) 2" x 2" Gauze Pads, (12) 3" x 3" Gauze Pads, (4) Oval Eye Pads, (2) Triangular Bandage, (2) 2" x 4yd. Conforming Bandage, (1) 4" x 2 yd. Conforming Bandage, (1) 3" Elastic Bandage, Scissors and Forceps

1202113 OSHA Compliant \$89.99 EA



MATT-KLEEN™ ALL PURPOSE DISINFECTANT CLEANER

- Helps stop the spread of skin diseases and infections
- Ideal for wrestling and gymnastic mats, training tables and shower floors
- Highly concentrated; 2 oz. makes one full gallon

1092479 Gallon \$129.99 EA



WHIZZER®

- Multipurpose concentrate kills HIV-1 (AIDS virus), MRSA, Hepatitis B & C, and other viruses. Kills strep, staph and fungus germs on contact.
- Cleaner, fungicide, mildewstat, virucide and deodorizer - all in one. Comes complete with 2 FREE Pint spray bottles.
- One ounce of concentrate mixed with water makes a gallon of full-strength disinfectant. 128 dilutions per gallon.
- Fast. Apply directly to mats, floors, walls, training tables, locker rooms, or personal items. Just wipe dry.

30 Day Limited Warranty
MU230201 1 Gallon + 2 FREE Pint Spray Bottles \$119.99 CASE



TUF-SKIN® COLORLESS SPRAY

- Helps secure all tapes, underwrap and elastics to the skin in order to reduce friction and help prevent blisters and chafing
- Same formula as original Tuf-Skin® without the color; will not stain skin or clothes
- FAA regulations, can not ship via overnight air or 2nd day air.

1078626 10 oz. Can \$23.99 EA



TREATMENT TABLE WITH BACK

- Hardwood legs, laminated shelf and adjustable backrest
- Scratch resistant topcoat finish
- Fast and easy assembly
- Seamless rounded corners
- 2" firm foam padding
- Heavyweight, knit-backed upholstery
- 400lb capacity

1453885 78" L x 30" W x 31" H \$1,199.99 EA



FLEX-I-WRAP

- 4" wide plastic film on a roller makes wrapping a one-handed task
- Replaces elastic wraps at a fraction of the cost
- Provides compression while clear film allows inspection of injury
- Patented, built-in hand brake on roller makes tearing easy

MDFLXWRP
1082562
1082555

6 rolls w/ handle
 Handle only
 6 rolls only



\$89.99 SET
 \$17.99 EA
 \$79.99 EA

SELECT



NUMERO 10

- New golf ball structured surface for pure flight
- Great quality match ball.
- NFHS/NCAA approved, 32-panel hand-sewn
- Color Options: White/Black, Yellow/Blue, White/Blue, White w/ Red/Purple

1461141	Size 5-White	\$59 ⁹⁹ EA
1461791	Specify Color/Size	\$59 ⁹⁹ EA



THOR

- 1.0 mm PU cover with zero wing latex bladder
- Hand-sewn ball
- NFHS/NCAA approved

1461142	Size 5-White w/ Blue/Silver	\$43 ⁹⁹ EA
----------------	-----------------------------	-----------------------



CLUB DB

- Dual bonded 3mm textured panels
- Seams are stitched and heat sealed for less water uptake
- Ideal training ball for all levels. SR bladder for longer air retention

1461143	Size 5 - White w/ Black	\$34 ⁹⁹ EA
----------------	-------------------------	-----------------------



ROYALE

- 1.7mm PU cover with zero wing bladder
- NFHS/NCAA approved
- Hand-sewn
- Color Options: White/Blue, Red/Purple, Green/Orange, White/Blue-Size 4

1461140	Size 5-White/Black/Gold	\$79 ⁹⁹ EA
1461786	Specify Color/Size	\$79 ⁹⁹ EA



CLASSIC

- Premium camp and rec ball for grass
- Newly developed PVC-composite
- Butyl bladder for better air retention
- Sz. 3 Orange; Sz. 4- Yellow; Sz. 5 - White

1456061	Specify Size/Color	\$24 ⁹⁹ EA
----------------	--------------------	-----------------------



PHANTOM X

- Ultra abrasion-resistant PU cover with texture
- High Retention Latex bladder system
- Hand-stitched
- Optimal for training or match-level play
- 2 Year Limited Warranty**

1397721	Size 5 - Specify Color	\$64 ⁹⁹ EA
----------------	------------------------	-----------------------

Available 4-1-23



ATTACK MS

- Machine stitched butyl bladder construction
- Outer 0.65 shiny PU
- 2.5mm EVA backing
- Color Options: **Black, Royal**

1464000	Size 5-Specify Color	\$24 ⁹⁹ EA
----------------	----------------------	-----------------------



VORACITY

- Soft PU cover
- Hand stitched
- High Retention Latex bladder system
- 2 Year Limited Warranty**
- Color Options: **Black.**

1378532	Size 5 - Black	\$45 ⁹⁹ EA
----------------	----------------	-----------------------



CHAMPIONSHIP II

- Premium high-performance glossy PU cover
- High Air Retention Latex Bladder
- Hand-stitched
- Optimal for match-level play
- 2 Year Limited Warranty**

1395098	Size 5 - White/Black	\$99 ⁹⁹ EA
----------------	----------------------	-----------------------



NFHS[®]
APPROVED



Baden
SPORTS

PERFECTION THERMO

- The Perfection Thermo is a match level thermal bonded soccer ball
- Panels are sealed together to minimize water absorption to avoid misshaped water logged balls.
- NFHS Approved

1460266 Size 5 \$129⁹⁹ EA

NFHS[®]
APPROVED



NEW!

Wilson
NCAA VIVIDO MATCH

- Unique 20-panel design optimizes geometric striking zones
 - VST (Visual Spin Technology) uses color variance for easier spin detection and ball tracking
 - Advanced construction and a high performance foam lining generate higher energy return upon impact
 - NFHS, NCAA and FIFA approved
- Color Options: **White, Yellow**
Size: **5.**

WLWS100090 Size 5-Specify Color \$110⁹⁹ EA

NFHS[®]
APPROVED



Baden
SPORTS

THERMO

- The Thermo ball provides a seamless transition from practice to a game ball
- Same Thermal bonded construction as The Perfection
- More affordable ball for game or practice
- NFHS Approved

1460267 Size 5 \$59⁹⁹ EA

NFHS[®]
APPROVED



CLUB ELITE TEAM

- Synthetic leather with Aerowtrac grooves for superior flight
 - Modern fuse technology for enhanced touch and feel
- Color Options: **100 - WH/BK/SI**
Size: **5.**

NKCU8057 Size 5 \$62⁰⁰ EA



SPALDING
TF-SC5

- Pro Game Ball - Thermal bonding panel technology
- Top grade performance composite cover
- Premium cushion foam backing
- Cloth-reinforced bladder
- NFHS approved

WC648678 Size 5 \$109⁹⁹ EA

NFHS[®]
APPROVED

NEW!



ACADEMY TEAM

- Aerowtrac grooves improve flight durability
 - Textured casing for improved touch and feel
 - 12 panel design for true and accurate ball flight
 - Machine stitching with butyl bladder
- Color Options: **102 - WH/BK/BL**
Size: **3, 4, 5.**

NKCU8047 Specify Size \$32⁰⁰ EA

NEW!



Wilson
VEZA

- Unique 20-panel design optimizes geometric striking zones for controlled, precise strikes
- Textured cover offers durability and performance
- Advanced carcass and bladder construction provides durable and balanced round shape
- NFHS approved

WLWS1001001XB05 Size 5 \$69⁹⁹ EA

NEW!



PARK TEAM

- 12 panel designed ball for increased durability
- Machine-stitched TPU with butyl bladder
- Ideal for camps or recreational usage
- Size: 3, 4, 5

NKCU8033 Specify Size-3, 4, 5 \$22⁰⁰ EA

NFHS[®]
APPROVED



NEW!

Wilson
NCAA VANQUISH MATCH

- A textured cover offers great touch with a 20-panel fused construction, to keep moisture out and extend durability
 - Improved ball tracking, high visibility, tech graphics with color accents allowing the player to easily track the ball
 - NFHS approved for Size 5
- Color Options: **White**
Size: **4, 5.**

WLWS100110 Size 4, 5 \$42⁹⁹ EA

NFHS[®]
APPROVED



SPALDING
TF-5000

- Competition Game Ball - Hand Stitched
- Tournament Composite Cover
- Latex rubber bladder
- NFHS approved

WC647929 Size 5 - Black/White \$94⁹⁹ EA

SELECT PACKS



Brilliant Super HSB V22 NFHS - 6 Pack

- ✓ New cutting edge design that improves the best ball in the world
- ✓ Teijin microfiber PU cover with 3 layer underlining
- ✓ Patented zero wing latex bladder with diamond ball textured surface
- ✓ 32 hand crafted panels that ensures true flight
- ✓ Underlying foam gives a light touch with comfortable softness
- ✓ NFHS/NCAA approved
- ✓ Color: White w/blue/black - includes ball bag
- ✓ 3 Year Limited Warranty

1461799 Size 5 \$764.99 pack



Royale V22 - 10 Pack

- ✓ NFHS/NCAA approved-hand stitched
- ✓ 1.7 mm textured PU cover with zero wing latex bladder
- ✓ One of Select's all time best selling match balls
- ✓ Includes ball bag
- ✓ Color options: white w/red, white w/blue, white w/green
- ✓ 3 Year Limited Warranty

1461755 Size 5-Specify Color \$649.99 pack



Numero 10 V22 - 10 Pack

- ✓ Select's legendary best selling match ball
- ✓ New Diamond textured hand stitched panels
- ✓ 1.5 mm PU cover with zero wing latex bladder
- ✓ Color options: white w/blue, yellow w/yellow/blue, white w/black/gold, white w/green/orange
- ✓ Includes ball bag
- ✓ Size 4 in white w/black/gold, yellow w/yellow/blue
- ✓ 2 year warranty

1461760 Size 5-Specify Color \$499.99 pack



Viking DB V22 - 10 Pack

- ✓ Great match and practice ball for all levels
- ✓ NFHS/NCAA approved, SR bladder that provides high air retention
- ✓ 1.1 mm PU cover with zero wing bladder
- ✓ Duel Bonded - panels stitched and glued for less water uptake
- ✓ Color: White w/red/green, White w/blue/green
- ✓ Includes ball bag
- ✓ 2 year limited warranty

1461770 Size 5 \$428.99 pack



Thor - 10 Pack

- ✓ Top selling match and practice ball
- ✓ NFHS/NCAA approved-hand stitched
- ✓ 1.0 mm PU cover with 7-wing latex bladder
- ✓ Color: white w/blue/silver
- ✓ Top value for tight budgets
- ✓ White w/blue/Silver - includes ball bag
- ✓ 2 year limited warranty

1461801 Size 5 \$348.99 pack



Diamond V22 - 10 Pack

- ✓ Top class match/practice ball for all levels. Durable and strong
- ✓ Butyl bladder for long air retention.
- ✓ Made with TPU film with lamination of 2mm TPE foam
- ✓ Hand stitched, 32 panel ensures true flight.
- ✓ Size 4,5 - White w/blue/red
- ✓ Includes ball bag
- ✓ 2 Year Limited Warranty

1461773 Specify Size 4,5 \$348.99 pack



Club DB V22 - 10 Pack

- ✓ The best practice ball just got better
- ✓ Dual Bonded, stitched and bonded for less water uptake
- ✓ Textured 3mm TPU cover laminated with foam for softness
- ✓ SR bladder for longer air retention
- ✓ White w/blue/yellow (size 3,4,5) White w/red/yellow (size 5)
- ✓ Orange/w/blue/yellow (size 4,5) White w/green/yellow (size 5) All White (size 3,4,5)
- ✓ Includes ball bag
- ✓ 1 year limited warranty

1461776 Specify Size/Color \$299.99 pack



Turf - 24 Pack

- ✓ New TURF NFHS approved ball
- ✓ 1 mm grain textured PU cover for hard surfaces and turf
- ✓ Butyl bladder for great air retention
- ✓ Color: Yellow w/orange/black
- ✓ Sizes 4,5 - Includes two ball bag
- ✓ 1 year stitching warranty

1457208 Size 5 \$849.99 pack



Blaze DB - 10 Pack

- ✓ Dual Bonded - hand stitched
- ✓ Seams are sealed with heat activated glue for less moisture uptake
- ✓ PU lightly textured laminated panels with 3.5 mm thick foam
- ✓ Utilizing a SR bladder for excellent air retention
- ✓ Includes ball bag
- ✓ Size 5 - White w/blue/red

1461800 Size 5 \$588.99 pack



Classic - 10 Pack

- ✓ Premium camp or recreational ball.
- ✓ Newly developed PVC-composite with improved softness
- ✓ Butyl bladder for long air retention.
- ✓ Includes ball bag
- ✓ Size 3,4,5 - Color: yellow



Over-Vest Training Bib - Set of 12/Color

- ✓ Comfortable and cost efficient
- ✓ 100% poly mesh
- ✓ Horizontal panel convenient for logo screening
- ✓ Color options: pink, green, red, orange, blue, yellow
- ✓ Size junior, senior



Futsal Magico - 6 Pack

- ✓ PU surface for optimal durability
- ✓ Low bounce for perfect control
- ✓ Hand stitched 32 panel for perfect flight
- ✓ Butyl bladder for longer air retention
- ✓ Includes ball bag -size jr, sr
- ✓ 1 year limited warranty

RUBBER/SYNTHETIC

MacGregor MATCH 32

- Quality laminated PU cover
- Butyl bladder for maximum air retention
- Foam backing for improved feel
- NFHS approved



1390104

Size 5

\$42.99 EA ★



Voit RUBBER BALL

- Waterproof for fun outdoor play

VCS33XXX

Specify Size

\$19.99 EA ★



BEST SELLER

MacGregor CLASSIC 32

- Long lasting, sewn synthetic cover
- 32 panel ball with butyl bladder
- 2-ply backing

MCS30005

Specify Size

\$24.99 EA ★



FUTSAL PRO

- Hand-sewn construction has tighter seams for durability.
- High-contrast graphics help you easily track the ball.
- Official Futsal size and weight

NKDH1992

\$42.00 EA



Voit INDOOR FELT

- Nylon wound, molded felt cover
- Soft kick feel for virtually painless play

VSBMFEL5

Specify Size

\$32.99 EA ★



SELECT FUTSAL JINGA

- Synthetic leather
- Low bounce for easy control
- Hand sewn 32-panel construction

Size: Junior, Senior

Color Options: White/Blue, Yellow/Blue.

1453626

Specify Size/Color

\$59.99 EA



MacGregor RUBBER BALL

- Best value playground soccer ball anywhere
- Extended-life molded construction

MCSBR5XX

Specify Size

\$16.99 EA ★



BSN SPORTS

YMCA HERITAGE

- Soft PVC cover
- Machine stitched

1384325

Size 5 - Silver

\$21.99 EA ★

1384326

Size 4 - Black

\$21.99 EA ★

1384327

Size 3 - Red

\$21.99 EA ★



MacGregor LIMITED

- PVC soft cover
- Machine stitched

1262698

Senior Size

\$29.99 EA ★



MacGregor MERCURY CLUB

- Soft PVC cover
- Machine stitched
- Butyl bladder

70200235

Size 5 - Silver/Black/Orange

\$25.99 EA ★

70200234

Size 4 - Silver/Black/Green

\$25.99 EA ★

70200233

Size 3 - Silver/Black/Blue

\$25.99 EA ★



HEX NETS

SOCCER NETS

SQUARE MESH

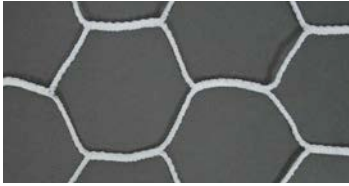

ORANGE



WHITE

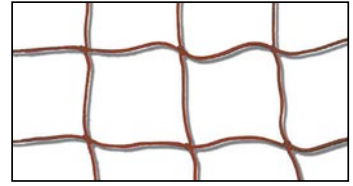

CODE	SIZE	BODY	RECOMMENDED USE	COLOR	PRICE
SN383PROY	8'H x 24'W x 5'D x 10'B	5.0 mm braided PE	College & Pro	Orange	\$419 ⁹⁹ PR ★
SN383PROW	8'H x 24'W x 5'D x 10'B	5.0 mm braided PE	College & Pro	White	\$419 ⁹⁹ PR ★
1248876	8'H x 24'W x 4.5'D x 10'B	4.0 mm braided PE-Hexagonal	College & Pro	Black/White	\$449 ⁹⁹ PR ★
1397773	8'H x 24'W x 3'D x 8.5'B	4.0 mm braided PE-Hexagonal	College & Pro	Black/White	\$399 ⁹⁹ PR ★
1367770	8'H x 24'W x 3'D x 5'B	4.0 mm braided PE-Hexagonal	College & Pro	Black/White	\$369 ⁹⁹ PR ★
1367769	8'H x 24'W x 3'D x 8.5'B	4.0 mm twisted knotted PE	College & Pro	White	\$449 ⁹⁹ PR ★
1367768	7'H x 21'W x 3'D x 7.5'B	4.0 mm twisted knotted PE	Club/Recreational	White	\$319 ⁹⁹ PR ★
1367767	6.5'H x 18.5'W x 2'D x 7'B	4.0 mm twisted knotted PE	Club/Recreational	White	\$299 ⁹⁹ PR ★
1367766	6.5'H x 12'W x 2'D x 7'B	4.0 mm twisted knotted PE	Club/Recreational	White	\$249 ⁹⁹ PR ★
1054729	8'H x 24'W x 4'D x 8'B	3.0 mm twisted knotted PE	High School/Club	White	\$349 ⁹⁹ PR ★
1054678	7'H x 21'W x 4'D x 8'B	3.0 mm twisted knotted PE	Club/Recreational	White	\$269 ⁹⁹ PR ★
1054682	6.5'H x 18.5'W x 3'D x 6'B	3.0 mm twisted knotted PE	Club/Recreational	White	\$249 ⁹⁹ PR ★
1054699	6.5'H x 12'W x 3'D x 6'B	3.0 mm twisted knotted PE	Club/Recreational	White	\$219 ⁹⁹ PR ★
1367772	4.5'H x 9'W x 2'D x 4.5'B	3.0 mm twisted knotted PE	Club/Recreational	White	\$219 ⁹⁹ PR ★
1367771	4'H x 6'W x 2'D x 4'B	3.0 mm twisted knotted PE	Club/Recreational	White	\$199 ⁹⁹ PR ★
SN383SNRY	8'H x 24'W x 5'D x 10'B	3.0 mm twisted PE	High School/Club	Orange	\$249 ⁹⁹ PR ★
SN383SNRW	8'H x 24'W x 5'D x 10'B	3.0 mm twisted PE	High School/Club	White	\$249 ⁹⁹ PR ★
1033526	8'H x 24'W x 5'D x 10'B	2.5 mm twisted PE	Recreational	Orange	\$199 ⁹⁹ PR ★
SN383ECOW	8'H x 24'W x 5'D x 10'B	2.5 mm twisted PE	Recreational	White	\$199 ⁹⁹ PR ★



SAND BAGS

- Holds 50 lbs. of sand (not included)
- Heavy duty pvc handle for easy carrying
- Zipper closure

1336542 22" x 15" \$109⁹⁹ SET OF 4 ★



TWIST-IN NET HOOKS

- Color: White

STNTCLIP \$1.99 EA ★
STNETCLP \$59⁹⁹ 50/SET ★



HOOK & LOOP NET STRAPS

- 16" straps for 3" diameter and larger items
- 11" straps for 2" diameter and smaller items

1033502 White - 16" \$64⁹⁹ SET OF 24 ★
1368869 White - 11" \$49⁹⁹ SET OF 24 ★



SCREW-IN NET HOOKS

- Set of 50

MSBNETHK \$34⁹⁹ SET OF 50 ★



FLIP OVER WHEEL KIT

- NO-FLAT wheels attach to any backstay up to 2" O.D.
- Compatible with all Alumagoal soccer goals (SGA400, SGA401, SGA402, SGA403 and all 3" Round Classic Club goals)
- Sold in sets of (2) wheels
- Two sets are required for a pair of goals

SCGWHLXX \$299⁹⁹ SET OF 2 ★

PERMANENT GROUND ANCHORS

- 12" long; 2" O.D galvanized steel
- 4 anchors per goal required

ZSTSPANCHX

\$139⁹⁹ SET ★

AUGER STYLE GROUND ANCHOR

- 12" long; 12 mm O.D. galvanized steel rod
- 4 anchors per goal required

SGAUGER

\$39⁹⁹ EA ★



SPIKE WITH CABLE LANYARD

- 14" galvanized spike
- 4 per goal required

SGSPIKE

\$36⁹⁹ EA ★



FREE NETS & GROUND ANCHORS INCLUDED

ALUMAGOAL®

4" ROUND CLASSIC GOALS

- Official size 8'H x 24'W x 3'D x 9'B
- Meets NCAA, NFSHA and FIFA specs
- Front face is 4" round, powder coated custom aluminum extrusion for superior strength
- Backstays are 2" round powder coated aluminum
- Rear crossbars are 2" round galvanized steel
- Built-in net clip track with clips
- Includes 4mm white nets and ground anchors
- 360 lbs./pr



SGA400
SCGWHLXX
1367769

Complete Unit
Flip Over Wheel Kit - 1 Pr/Set
4mm - Replacement Net

\$6,499⁹⁹ PR ★ **S&H**
\$299⁹⁹ SET ★
\$449⁹⁹ PR ★



GROUND ANCHOR ATTACHMENT



*** WHEEL KIT CAN BE ADDED**



ROUND DESIGN SHOWING NET CLIP TRACK



ALUMAGOAL®

FOOTBALL/SOCCER COMBO GOAL

- Meets High School soccer and football regulations
- 10'H football uprights are constructed of 2" square aluminum tubing
- Width of uprights can be adjusted for H.S. (23'4") or Collegiate (18'6") play or removed for soccer play
- Soccer goal size - 8'H x 24'W x 3'D
- Soccer post are constructed of 11 gauge 2" x 4" steel tubing
- Crossbars are constructed of 14 gauge 2" x 4" steel tubing
- Two-piece engineered crossbar for increased ease of shipping and installation

- Euro style backstays are constructed of 14 gauge - 1.5" steel tubing
- Extremely corrosion resistant galvanized and white powder coated finish
- Goals include backstays, 4mm soccer nets, net fasteners and ground stakes
- Optional Ground Sleeves available for semi-permanent installation

5 Year Limited Warranty

SGFBCOM
1367769
1308082

1 Pair of Goals - Includes Nets
4mm - Replacement Net
Ground Sleeves - 4/Set

\$4,999⁹⁹ PR ★ **S&H**
\$449⁹⁹ PR ★
\$279⁹⁹ SET ★



ALUMGOAL®



**NATURAL ALUMINUM
FREE NETS & GROUND ANCHORS INCLUDED**



**HEAVY WALL BOTTOM BAR
ON 12', 18.5', 21' AND 24' MODELS**



**NET CLIP TRACK IN TOP
& SIDE FRAMES**



SOCCER GOAL SAFETY PADDING

- Meets NFSHSA rule regarding safety padding
- Fits 2" x 4", 4" x 4" and 3" & 4" round soccer goals
- High density 1" thick foam covered in white vinyl coated nylon
- Hook & loop fasteners attached
- 1 pair per goal

3" ROUND CLASSIC CLUB GOALS

- Front face is 3" round custom aluminum extrusion
 - Built in net clip track
 - Backstays are 2" round heavy wall aluminum tubing
 - Double reinforced Tig welded corners
 - Stainless steel hardware
 - Includes 4mm White Net, Net Clips and Ground Anchors
 - Includes Back Bottom Bar (24', 21', 18.5' & 12' models only)
 - Meets NFSHSA specs (8' x 24' SGA300 model only)
- 5 Year Limited Warranty**



NATURAL ALUMINUM 3" ROUND CLUB GOALS

SGA320	8'H x 24'W x 3'D x 8.5'B - 330 lbs./pr.	\$3,999 ⁹⁹	PR ★ Sold
SGA321	7'H x 21'W x 3'D x 7.5'B - 301 lbs./pr.	\$3,699 ⁹⁹	PR ★ Sold
SGA322	6.5'H x 18.5'W x 2'D x 7'B - 260 lbs./pr.	\$3,499 ⁹⁹	PR ★ Sold
SGA323	6.5'H x 12'W x 2'D x 7'B - 208 lbs./pr.	\$3,099 ⁹⁹	PR ★ Sold
SGA324	4.5'H x 9'W x 2'D x 4.5'B - 134 lbs./pr.	\$2,599 ⁹⁹	PR ★ Sold
SGA325	4'H x 6'W x 2'D x 4'B - 118 lbs./pr.	\$2,399 ⁹⁹	PR ★ Sold

1089363DS 72"H **\$599**⁹⁹ PR ★ **Sold**



ALUMAGOAL[®]



**WHITE POWDER-COATED
FREE NETS & GROUND ANCHORS INCLUDED**



3" ROUND CLASSIC CLUB GOALS

- Front face is 3" round custom aluminum extrusion
 - Built in net clip track
 - Backstays are 2" round heavy wall aluminum tubing
 - Double reinforced Tig welded corners
 - Stainless steel hardware
 - Includes 4mm White Net, Net Clips and Ground Anchors
 - Includes Back Bottom Bar (24', 21', 18.5' & 12' models only)
 - Meets NFSHA specs (8' x 24' SGA300 model only)
- 5 Year Limited Warranty**



POWDER-COATED WHITE 3" ROUND CLUB GOALS

SGA300	8'H x 24'W x 3'D x 8.5'B - 330 lbs./pr	\$4,999 ⁹⁹ PR ★
SGA301	7'H x 21'W x 3'D x 7.5'B - 301 lbs./pr.	\$4,299 ⁹⁹ PR ★
SGA302	6.5'H x 18.5'W x 2'D x 7'B - 260 lbs./pr.	\$3,999 ⁹⁹ PR ★
SGA303	6.5'H x 12'W x 2'D x 7'B - 208 lbs./pr.	\$3,599 ⁹⁹ PR ★
SGA304	4.5'H x 9'W x 2'D x 4.5'B - 134 lbs./pr.	\$2,999 ⁹⁹ PR ★
SGA305	4'H x 6'W x 2'D x 4'B - 118 lbs./pr.	\$2,799 ⁹⁹ PR ★



**HEAVY WALL BOTTOM BAR
ON 12', 18.5', 21' AND 24' MODELS**



**NET CLIP TRACK IN TOP
& SIDE FRAMES**



GROUND ANCHORS AND NET CLIPS INCLUDED!

ALUMAGOAL®



4" EURO ALUMAGOAL

- Official size 8'H x 24'W x 3'D x 9'B
- Meets NCAA, NFSHSA and FIFA specs
- Crossbars and posts are 4" round, powder coated custom aluminum extrusion for superior strength
- European backstays are 2" round powder coated aluminum
- Double reinforced tig welded corners
- Built-in net clip track with clips
- Stainless steel hardware
- Includes full depth 4mm white nets and sand bag anchors
- 386 lbs. Per Pair

\$7,999⁹⁹

SGA401 ★ Complete Unit

1367769 ★ Replacement Net **\$449⁹⁹**



Fully adjustable bottom bar slides **IN FRONT** on FB Post

4" EURO STADIUM ALUMAGOAL

- Official size 8'H x 24'W x 3'D x 9'B
- Meets NCAA, NFSHSA and FIFA specs
- Meets Safety & Performance Specification ASTM F2950-14
- Crossbars and posts are 4" round, powder coated custom aluminum extrusion for superior strength
- European backstays are 2" round powder coated aluminum
- Double reinforced tig welded corners
- Built-in net clip track with clips
- Stainless steel hardware
- Includes 4mm Black/White, half depth hexagonal nets and sand bag anchors and n-flat transport wheels
- Fully adjustable bottom bar that fits in front of Football Goal Post
- 450lbs. Per Pair



5 Year Limited Warranty



**DESIGNED FOR FOOTBALL/
SOCCER FIELDS**



\$7,899⁹⁹

SGA403 ★ Complete Unit

1367770 ★ Replacement Net **\$369⁹⁹**

ALUMAGOAL®



MANCHESTER MATCH GOAL

- Official size 8'H x 24'W x 3'D x 9'B
- Meets NCAA, NFSHSA and FIFA specs
- Crossbars and posts are 4" round, powder coated custom aluminum extrusion for superior strength
- Backstays are 2" round powder coated aluminum
- Double reinforced tig welded corners
- Built-in net clip track with clips
- Stainless steel hardware
- Includes 4mm Black/White hexagonal nets, sand bag anchors and transport wheels
- 480 lbs. Per Pair

\$8,999⁹⁹

SGA402 ★ Complete Unit 

1397773 ★ Replacement Net **\$399⁹⁹**



NET CLIPS INCLUDED
FAST SETUP & TAKEDOWN



ROUND DESIGN
SHOWING NET CLIP TRACK



FLIP-OVER WHEELS FOR EASY TRANSPORT!

ALL PURPOSE BACKSTOP SYSTEM

- Backstop system measures 21'H x 65'W
- Constructed with (4ea) 3.5" galvanized 11 guage steel poles
- Choice of 3mm 4" mesh or 1.75" mesh (275 lb. breaking strength)
- Easy on and off pulley system and (4ea) galvanized steel ground sleeves
- Weight: 360 lbs.

1071436	System with 4" Netting	\$4,799⁹⁹ EA ★
1071435	System with 1 3/4" Netting	\$4,799⁹⁹ EA ★
1249071	Replacement Net - 4" Mesh	\$479⁹⁹ EA ★
1072230	Replacement Net - 1 3/4" Mesh	\$929⁹⁹ EA

BALL BOUNDARY SYSTEM

- Complete 12' high system with poles and netting
- Posts are constructed of 2 3/8"D x 3/16" wall aluminum tubing
- Ground Sleeves are aluminum with rubber caps
- Top and Bottom of Net is supported by nylon coated galvanized cable
- 1 3/4" 3mm braided knotless EHT black net
- Posts are spaced 20' apart
- Please allow 3 - 4 weeks for delivery

BBS12A	12'H System - Complete	\$33⁹⁹ FT ★
BBSNET12	12'H Replacement Net	\$12⁹⁹ LF



OFFICIAL COMPETITION FUTSAL GOAL

- Full aluminum construction
- White powder coated goal face with built-in net clip track
- Includes 4mm white net and non marring floor protectors

FGA500	7'H x 9'10"W x 2'8"D x 3'4"B - 185 lbs/pr	\$3,299⁹⁹ PR ★
1273489	Replacement Net - 4mm	\$249⁹⁹ PR ★



PORTABLE/FOLDABLE INDOOR SOCCER GOAL

- Goal measures 6.5'H x 12'W x 5'D
- 2" square steel powder coated face
- Both backstays fold inward for storage
- Non-marking floor pads are on each of the 4 contact points
- 3mm white net
- Weight: 174 lbs. per pair

SCGOAL5A	2 Goals with Nets	\$1,499⁹⁹ PR ★
SCGOAL5B	1 Goal with Net	\$799⁹⁹ EA ★
SCNET6DS	Replacement Net	\$159⁹⁹ EA ★





MacGregor
PLASTIC SHIN GUARDS

- Practical shin guards with plastic foam backing

MCS67WHS	Youth - 7"	\$9 ⁹⁹ PR ★
MCS69WHS	Adult - 9"	\$10 ⁹⁹ PR ★



MacGregor
PADDED SHIN GUARDS

- Stirrup design for ankle and shin protection
- Adjustable hook/loop strap

1276534	Youth - 7"	\$28 ⁹⁹ PR ★
1276541	Adult - 9"	\$29 ⁹⁹ PR ★



GOALIE GLOVES - ADULT

- White latex foam palm for grip and durability
- Gusseted fingers for comfort and ball control
- Hook-and-loop closure

Size: 8, 9, 7, 10.

MCS6LVA	Adult: 7-10	\$37 ⁹⁹ PR ★
----------------	-------------	-------------------------



GOALIE GLOVES - YOUTH

- White latex foam palm for grip and durability
- Gusseted fingers for comfort and ball control
- Hook-and-loop closure

Size: 4, 5, 6.

MCS6LVY	Youth: 4-6	\$34 ⁹⁹ PR ★
----------------	------------	-------------------------



33 PROTEC HG

- Hyla Cut 3mm heat treated Dura Grip latex for added durability on artificial turf surfaces
- Fixed guards for protection of the fingers
- NEW slit like wrist closure with velcro for easy on/off

Size: 7, 8, 9, 10, 11.

1461119	Specify Size	\$44 ⁹⁹ PR
----------------	--------------	-----------------------



77 SUPER GRIP

- 4 mm super soft latex for a perfect grip
- Latex on fingertips for stability and impact protection
- Removable finger protection
- Anatomical FIT System to ensure correct fit

Size: 7, 8, 9, 10, 11.

1461125	Specify Size	\$59 ⁹⁹ PR
----------------	--------------	-----------------------



**WEIGHTED BASES
AND WHEELS**

**SOCCER
INNOVATIONS**

SOCCER WALL TURF-SINGLE

- Lightweight and wind resistant
- Body design deflects balls keeping the mannequin upright
- Can be used on all surfaces
- Convert your Soccer Wall Turf to grass by adding a ground spike
- Sand Bag included

Color Options: **Neon Green/Blue, Black/
Green, Red/Blue, Yellow/Blue.**

1460517 Specify Color **\$199⁹⁹** EA



BOWNET

PORTABLE BARRIER NET

- Multi-sport portable barrier net
- Sets up in minutes
- Includes free carry bag with wheels

1344097 12' 6" H x 21' 6" W - 56 lbs. **\$589⁹⁹** EA

TRAINER / REBOUNDER GOAL

- Net can be adjusted for rebound, used for shooting skills, finishing skills or splitting one field into two
- Made of 1 7/8" diameter heavy wall aluminum tubing
- Spring button assembly requires no tools
- 30" steel anchoring shoes with permanent spikes
- 3mm 4" polyethylene net and carrying bag

1150858 7'H x 21'W **\$949⁹⁹** EA ★ **S&H**
1076127 Replacement Net **\$139⁹⁹** EA ★
1366835 Optional All Surface Shoe **\$259⁹⁹** PR ★

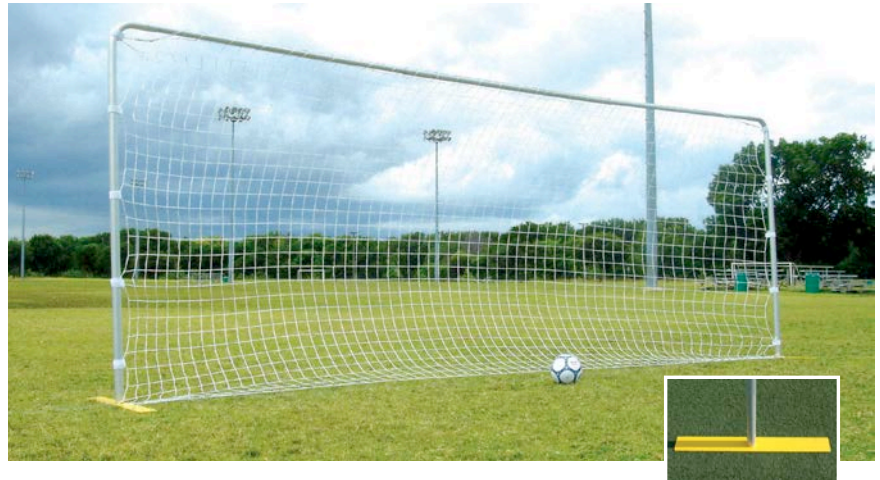

CARRY GOAL

- 8'H x 24"W goal, convenient carry bag, 4 ground stakes and one full size weather resistant net
- Constructed of 2" extra-strong aluminum tubing
- Fast break-down and convenient portability with a 3-piece front crossbar system
- Optional all-surface conversion shoes available. 2/pr required per goal
- Weight: 60 lbs.

STS6PTBG Goal & Net **\$829⁹⁹** EA ★ **S&H**
1366835 Optional All Surface Shoe **\$259⁹⁹** PR ★





BOWNET

PORTABLE SOCCER GOAL

- Rigid steel and fiberglass pole patented design
- No tools needed
- Assembles in minutes
- Tear resistant nylon netting
- Free carry case included

1297461	3'H x 5'W	\$169 ⁹⁹ EA
1394974	4'H x 6'W	\$219 ⁹⁹ EA
1297478	4'H x 8'W	\$249 ⁹⁹ EA
1297485	5'H x 10'W	\$389 ⁹⁹ EA
1297492	6'H x 12'W	\$419 ⁹⁹ EA
1305746	7'H x 14'W	\$449 ⁹⁹ EA
1462184	6.5'H x 18'W	\$484 ⁹⁹ EA
1315899	7'H x 21'W	\$799 ⁹⁹ EA
1315882	8'H x 24'W	\$829 ⁹⁹ EA



PK PRO 2 PRECISION SNIPER'S NET

- The PK-Pro II is designed to help increase players goal scoring abilities
- Scoring zones highlight where goalkeepers have a hard time reaching during a penalty kick, free-kick or long shot
- Fits 8' x 24' goals and includes hook/loop attachments to posts
- Carry Bag Included

1460513	\$399 ⁹⁹ EA
---------	------------------------

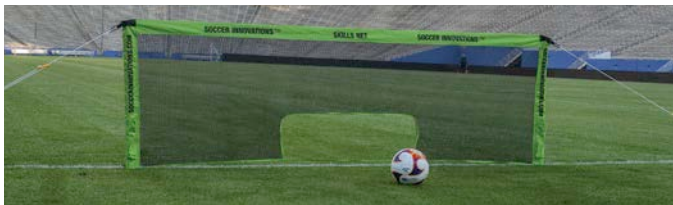

SOCCER SKILLS NET

- Develops air and ground passing skills
- Forces players to keep the ball on the ground
- Used for training as a simple passing gate
- 1'H x 3'W opening
- Carry Bag included

1460514	\$147 ⁹⁹ EA
---------	------------------------



BSN SPORTS

POP UP SOCCER GOAL

- Nylon net with fiberglass poles (2-pack)
- Ground stakes - attached to the net
- Pop-up design offers quick set-up and take-down
- Includes a carry bag for transport and storage

1393444	Royal - 30"W x 20"H x 18"D	\$89 ⁹⁹ PR ★
1393445	Red - 48"W x 38"H x 36"D	\$119 ⁹⁹ PR ★
1393446	Black - 72"W x 48"H x 48"D	\$159 ⁹⁹ PR ★



PUGG® SOCCER GOAL

- Great for soccer training, as well as field or floor hockey practice
- Pop-up design allows for quick and easy set up
- Anchoring pegs included to secure the goal to the ground
- Includes two goals, anchoring pegs and a storage bag

1277180	Yellow/Black - 30"W x 24"H x 22"D	\$109 ⁹⁹ PR
1063943	Royal - 48"W x 32"H x 32"D	\$164 ⁹⁹ PR
1063936	Gold - 72"W x 42"H x 42"D	\$199 ⁹⁹ PR



FUN FOR ALL AGES AND SKILL LEVELS

FUNNETS™ are made of a unique blend of materials designed specifically for outdoor use. Our heavy body construction is UV treated and is unbreakable. We know you have seen the imitation PVC plastic goals which are made of tubing designed for plumbing applications. These imitation goals have a very low impact resistance which can cause the piping to break and expose sharp edges.

Our **5 Year Unlimited Warranty** is the best in the industry.

DON'T BE FOOLED BY CHEAP IMITATIONS!

SPORTSTUFF® ROD

Our engineers searched for the perfect blend of flex/strength ratio. The result was the Sportstuff® rod. A safe, unbreakable rod with UV stabilizers, that lasts a lifetime!



FUNNETS® FITTINGS

The Funnet® fitting is molded out of ABS plastic with UV stabilizer for long life and strength. The fittings are longer for a more secure fit. Each fitting has set screws which allow the fitting to be tightened securely to the rod.



EASY TO CARRY AND TRANSPORT

FUNNET® GOALS

- 1 5/8" O.D. heavy duty rods and indestructible ABS fittings
- Comes complete with 3mm blue net

1. 3'H X 4'W X 1.5'D

1150056	Goal w/Net - 1 Each	\$199⁹⁹ EA ★
1150070	Replacement Net - 3mm, Blue	\$34⁹⁹ EA ★

2. 4'H X 6'W X 2'D

1150025	Goal w/Net - 1 Each	\$259⁹⁹ EA ★
1150049	Replacement Net - 3mm, Blue	\$44⁹⁹ EA ★

3. 6'H X 8'W X 3'D

1149982	Goal w/Net - 1 Each	\$279⁹⁹ EA ★
1150018	Replacement Net - 3mm, Blue	\$69⁹⁹ EA ★

4. 7'H X 10'W X 5'D

1249095	Goal w/Net - 1 Each	\$379⁹⁹ EA ★
1162356	Replacement Net - 3mm, Blue	\$79⁹⁹ EA ★



TRAVEL CHAIR BENCH

- Portable, collapsible bench that sets up in seconds
- Made from high-density 600D polyester
- Comes with mesh pouch at one end of bench for storage
- Bench is rated to support up to 300 lbs. per seat
- Option to customize with a one-color team name or logo to bench seat
- Allow 3 - 4 weeks for delivery of custom benches after art approval

1392979	6-Seater - Black	\$179⁹⁹ EA
1392980	6-Seater - Royal	\$179⁹⁹ EA
1451701	6-Seater - Black w/1-Color Logo on One Seat	\$199⁹⁹ EA
1451702	6-Seater - Royal w/1-Color Logo on One Seat	\$199⁹⁹ EA





SEGMENTED CORNER FLAGS

- 4-section 1" PVC material
- Bottom section is inserted and glued to the spring
- All 4-sections are connected by an interior 3mm cord, so pieces are not lost when disconnected
- 4 Flags/Set - Carry bag included

1238624 72"H **\$149⁹⁹** SET ★

COACH'S CHOICE

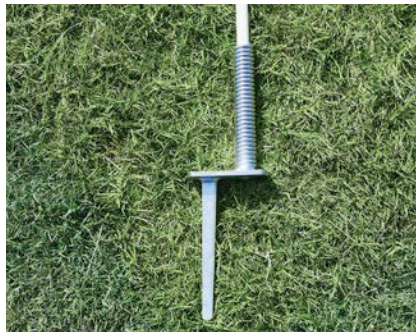

FLEXIBLE CORNER FLAGS

- One piece construction
- 1/2" flexible PVC upright
- Steel spring base with ground stake
- 4 Flags/Set

MSSOCFLGY Poles w/Flags - 60"H **\$129⁹⁹** SET ★
1393451 Replacement Flag (4/Set) **\$16⁹⁹** SET ★

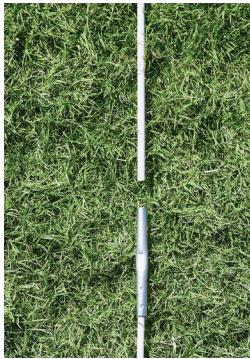
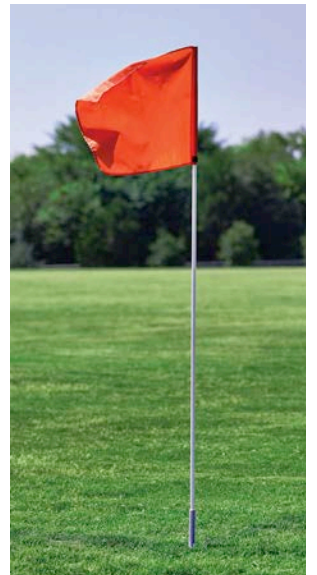

FIBERGLASS CORNER FLAGS

- Extra durable and light weight
- Two piece pole
- 4 Flags/Set

20012999 60"H **\$59⁹⁹** SET ★

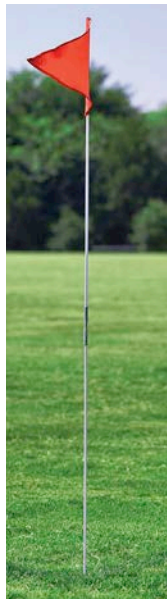

INDOOR/OUTDOOR CORNER FLAGS

- Can be used on turf surfaces
- Uses a spring loaded dome base
- Base must be filled with sand
- 4 Flags/Set

1251838 60"H **\$139⁹⁹** SET ★

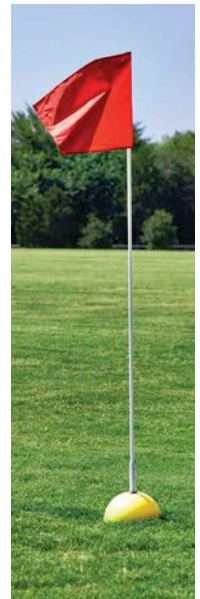

CORNER FLAG CARRY BAG

- Carries corner flags or coaching sticks
- Black Only

1366514 70"L x 7"W **\$24⁹⁹** EA ★



RUBBER BASE CORNER FLAGS

- 4-Section 1" PVC material
- Sections are connected with 3mm bungee cord
- Pole inserts into heavy rubber base, no additional weight is required
- 4 Flags/Set

1454490 60"H **\$174⁹⁹** SET ★





LOW PROFILE CONES

- Soft, flexible and stack easily
- Color code your drills for more effective practice time
- Available in Orange, Yellow or Prism Packs (2 each: Blue, Green, Orange, Purple, Red and Yellow)
- 3"H x 7 3/4" diameter

1255706	Orange	\$19 ⁹⁹	DZN ★
1276558	Yellow	\$21 ⁹⁹	DZN ★
1255690	Prism Pack	\$16 ⁹⁹	DZN ★



LOW-PROFILE CONES WIRE CARRIER

- Holds up to 60 low-profile field cones (cones not included)
- Easy carry and storage

93095XXX	\$9 ⁹⁹	EA ★
-----------------	-------------------	------

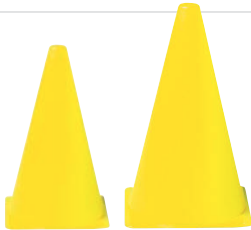

ECONOMY CONES

- Lightweight vinyl with small base
- No hole in top

MSCONE9XY	9"	\$7 ⁹⁹	EA ★
MS12CONEY	12"	\$9 ⁹⁹	EA ★



ORANGE GAME CONES

- Flexible PVC with weighted base for added stability
- Stack easily for storage

1040814	12"	\$17 ⁹⁹	EA ★
1040838	18"	\$24 ⁹⁹	EA ★
1040845	28"	\$44 ⁹⁹	EA ★
1040852	36"	\$249 ⁹⁹	EA ★
1040852SET	36"	\$249 ⁹⁹	SET OF 5



LARGE PROFILE CONES

- Soft-style - flexible and stackable
- Mix with low profile cones for various drills
- Approximately 6"H x 11" diam.

1273687	Orange	\$34 ⁹⁹	DZN ★
1336511	Yellow	\$34 ⁹⁹	DZN ★



REFLEX SOCCER CORNER FLAGS

- Reflex corner flag
- 1-Piece 1.33" O.D. PVC poles
- High visibility orange flags
- Includes: 4 flags with ground sockets & plugs and installation accessory kit. Storage bag not included

MK4RF6SP	66"H	\$199 ⁹⁹	SET
-----------------	------	---------------------	-----

- Includes: 6 flags with ground sockets & plugs and installation accessory kit. Storage bag not included.

MK6RF6SP	66"H	\$239 ⁹⁹	SET
-----------------	------	---------------------	-----

MKA101	Ground Socket with Plug	\$12 ⁹⁹	EA
---------------	-------------------------	--------------------	----

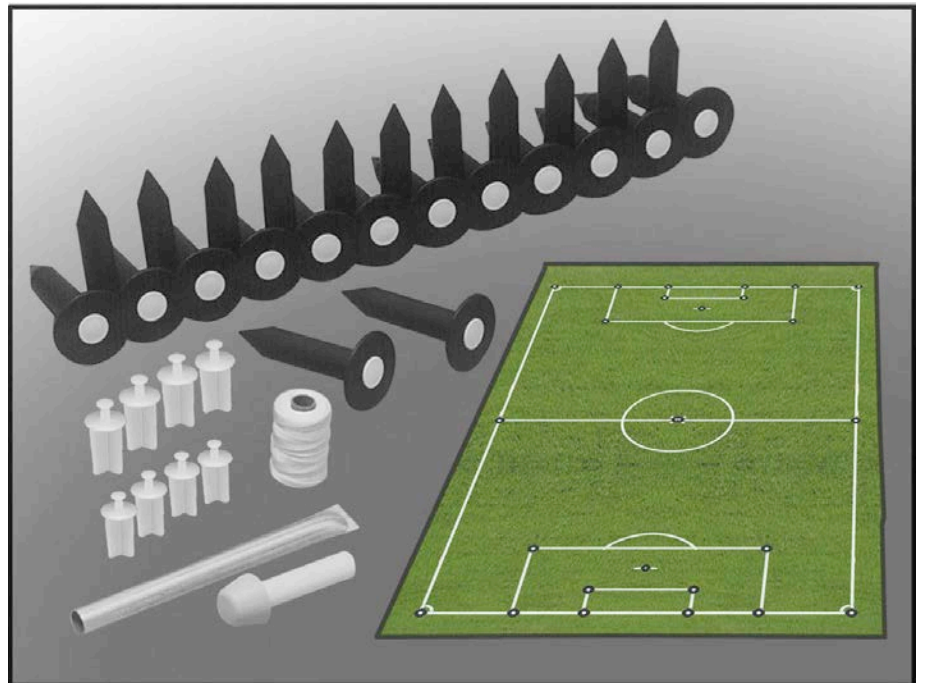

SOCCER FIELD LINING KIT

- Set includes: 25 sockets with plugs, 8 line pegs, installation accessory kit (IAK).
- All the necessary tools and products to establish permanent reference points for a regulation soccer field

MKSLP25	\$329 ⁹⁹	EA
----------------	---------------------	----



Soccer INNOVATIONS

MAGNETIC HINGED TACTIC BOARD

- Magnetic Tactic Board is one of a kind, unique design allows you to fold it and take it anywhere you go
- Features a full pitch view to help simulate game situations
- Divided sides to give you a more focused display on each half for tactical analysis



1460515	30cm x 45cm-Small	\$54 ⁹⁹ EA
1460516	90cm x 120cm-Large	\$241 ⁹⁹ EA

REFEREE/OFFICIALS WATCH

- Dual Game Timers - one counts down from full minutes, while the other counts up in 1/100 seconds
- Water resistant to 30 meters
- 50 memory recall Stopwatch with 1/100 second resolution
- User replaceable CR-2032 battery



1399653	SC-591	\$59 ⁹⁹ EA
---------	--------	-----------------------



CAPTAIN'S ARM BAND

- Velcro closure and extra elastic to keep in position on the arm
- Color Options: **Black, Blue, Orange, Pink, White, Green.**

1371625	Specify Color	\$7 ⁹⁹ EA
---------	---------------	----------------------



REVERSIBLE SCRIMMAGE VESTS

- Polyester mesh construction
 - Reversible jerseys with elastic bottom
- Color Options: **Dark Green/Gold, Orange/Gold, Red/Black, Royal/Gold, Royal/Red, Silver/Black.**

1262711	Adult	\$99 ⁹⁹ DZN ★
1262773	Youth	\$99 ⁹⁹ DZN ★

BSN SPORTS™

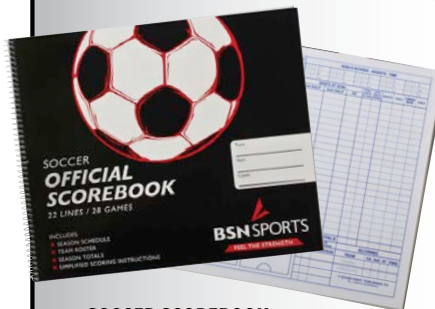

SOCCER SCOREBOOK

- 22 lines, 28 games
- Includes schedule and team roster

MSSOCBOK	\$13 ⁹⁹ EA
----------	-----------------------



SOCCER COACH'S BOARD

- Front half field and back full field writing surfaces
- Includes premium dry erase marker
- 8"W x 15 1/2"L

1388110	\$29 ⁹⁹ EA ★
---------	-------------------------



LINESMAN FLAGS

- One red and one yellow 12" x 15" nylon flag
- 18" wood sticks with knob handles

MSLFECON	\$16 ⁹⁹ PR ★
----------	-------------------------



DRY-ERASE BOARDS

- Large format enables entire team to see play
- 2 writing surfaces
- Great pen clip with premium dry erase marker
- 12 1/2"H x 16 1/2"W - 2 lbs.

1366485	\$39 ⁹⁹ EA
---------	-----------------------



LIGHTWEIGHT SCRIMMAGE VESTS

- Polyester mesh vest
- Reinforced neck and armholes
- Elastic waistband

Color Options: **Black, Gold, Kelly, Neon Green, Neon Orange, Neon Yellow, Orange, Purple, Royal, Scarlet.**

C46Y	K thru 3rd Grade	\$6 ⁹⁹ EA ★
C46	4th-6th Grade, Middle School & Up	\$7 ⁹⁹ EA ★
C47N	Adult (# 1-12) GO,KE,OR,PU,RO,SC,BK	\$94 ⁹⁹ DZN ★



WARNING CARDS AND WALLET

- Vinyl wallet holds one red and one yellow 3" x 4" plastic warning card
- Cards included

MSREFWAL	\$8 ⁹⁹ EA ★
----------	------------------------



CLASSIC ROUND POSTS

- Constructed of round tubular steel
- Powder coated finish
- Complete with brass winder and lacing bars
- Ground sleeves sold separately

3" Posts - Standard Height

1234404	Green	\$449 ⁹⁹ PR ★
1234411	Black	\$449 ⁹⁹ PR ★

2 7/8" Posts - Standard Height

1234428	Green	\$439 ⁹⁹ PR ★
1234435	Black	\$439 ⁹⁹ PR ★

GROUND SLEEVES

- Optional galvanized steel ground sleeves for Edwards Classic Round Post
- Sleeve plugs included

1235708	For 2 7/8" Posts	\$99 ⁹⁹ PR ★
1234473	For 3" Posts	\$129 ⁹⁹ PR ★



10 & UNDER TENNIS / PICKLEBALL

- Sized right for 10 & Under Tennis and Pickleball
- Constructed of 3" round tubular steel
- Powder coated finish - 36" above ground height
- Complete with brass winder and lacing bars
- Ground sleeves and net sold separately

1371705	Green Post	\$449 ⁹⁹ PR ★
1393373	Black Post	\$449 ⁹⁹ PR ★
1234473	Optional Ground Sleeve - 3" Post	\$129 ⁹⁹ PR ★



EXTERNAL RATCHET POSTS - 2 7/8"

- 2 7/8" OD, powder coated steel
- Complete with ratchet, caps and pulley
- Safety ratchet has a detachable handle
- For permanent installation or semi-permanent (with optional ground sleeves)

TP278GRN	Standard Post - Green	\$269 ⁹⁹ PR ★
1263138	Standard Post - Black	\$269 ⁹⁹ PR ★

GROUND SLEEVES

- PVC ground sleeves for 2 7/8" external ratchet posts

MTPGS27	\$66 ⁹⁹ PR ★
----------------	-------------------------

REPLACEMENT SAFETY RATCHET

- Heavy-duty steel safety ratchet
- Will fit most existing posts

MTRT5XXX	Green	\$34 ⁹⁹ EA ★
1002430	Black	\$34 ⁹⁹ EA ★

POST CAPS

- Steel post cap and pulley
- Fits 2 7/8" post only

MTCAP278	Green	\$44 ⁹⁹ EA ★
1002485	Black	\$44 ⁹⁹ EA ★



BRASS WINDER UNITS

- Includes removable handle and screw

1. 1234527	Winder Unit - Round Post	\$209 ⁹⁹ EA ★
2. 1234534	Winder Unit - Square Post	\$209 ⁹⁹ EA ★
1234510	Handle Only	\$69 ⁹⁹ EA ★



WIMBLEDON SQUARE POSTS

- Constructed from 3" square "box-section" steel
- Powder coated finish
- Complete with brass winder and lacing bars
- Ground sleeves sold separately

1234459	Green	\$489 ⁹⁹ PR ★
1234442	Black	\$489 ⁹⁹ PR ★

GROUND SLEEVES

- Optional galvanized steel ground sleeves for Edwards 3" Square Posts

1234480	\$129 ⁹⁹ PR ★
----------------	--------------------------





Throughout their 130 year history, Edwards Sports Products have been associated with tennis at the highest level, supplying Grand Slam tournaments around the world including Wimbledon & US Open. The famous 40LS net features double netting on the top six rows and a specially designed polyester headband which maximizes durability and minimizes distortion. The 30LS, 30LSDC and 40LS feature extra heavy duty 3.5mm braided polyethylene twine. These tennis nets have a quad stitched white top band & a plastic coated steel cable. The 30LS, 30LSDC & 40LS use only the finest quality materials.

Standard net posts are spaced 42' apart. 42' nets measure 41'6" to fit between these posts. For 40' post spacing, use the 40' net which measures 39'6".



MacGregor

- 2.5mm high density braided polyethylene net body
- Heavy duty 18 oz. vinyl coated headband
- 4 rows of lock stitching in headband
- 5/8" diameter fiberglass dowel
- Center strap not included

TN300V42Y 42'L \$209⁹⁹ EA ★



MacGregor

- 3.6mm high density braided polyethylene net body
 - Heavy duty 18 oz. vinyl coated headband
 - 5/8" diameter fiberglass dowels
 - Center strap not included
- 3 Year Limited Warranty**
Length: 40', 42'.

TN500 Specify Length \$259⁹⁹ EA ★



COACH'S CHOICE

EDWARDS

- 3.5mm high density braided polyethylene net body
 - Heavy duty 18 oz. vinyl coated headband
 - 5 rows of double center mesh
 - 5/8" diameter fiberglass dowels
 - Center strap and tapered center
- 5 Year Limited Warranty**

1234367 42'L \$349⁹⁹ EA ★



EDWARDS

- 3.5mm high density braided polyethylene net body
 - Heavy duty 155mm polyester headband
 - 5 rows of double center mesh
 - 5/8" diameter fiberglass dowels
 - Center strap and tapered center
- 5 Year Limited Warranty**

1162462 42'L \$369⁹⁹ EA ★



EDWARDS

- 3.5mm braided, knotless nylon netting with 1-3/4" square mesh
- Heavy duty vinyl coated headband
- 5/8" diameter fiberglass dowels
- 42"H x 22"L used for 10 & Under Tennis
- 36"H x 22"L used for 8 & Under Tennis and Pickleball

1296785 10 & Under-42"H x 33"L \$249⁹⁹ EA ★
1296778 8 & Under/Pickleball-36"H x 22"L \$199⁹⁹ EA ★



EDWARDS

- 3.0mm high density braided polyethylene net body
 - Heavy duty 18 oz. vinyl coated headband
 - 7/8" diameter fiberglass dowels
 - Center strap and tapered center
- 3 Year Limited Warranty**

1234374 42'L \$259⁹⁹ EA ★



EDWARDS

- 3.0mm high density braided polyethylene net body
 - Heavy duty 18oz vinyl coated headband
 - 5 rows of double center mesh
 - 5/8" diameter fiberglass dowels
 - Center strap and tapered center
- 5 Year Limited Warranty**

1234398 42'L \$329⁹⁹ EA ★



EDWARDS

- 3.5mm high density braided polyethylene net body
 - Heavy duty 18 oz. vinyl coated headband
 - 5/8" diameter fiberglass dowels
 - Center strap and tapered center
 - Edwards most popular net, and the one used at Wimbledon
- 3 Year Limited Warranty**

1162479 42'L \$319⁹⁹ EA ★

RolDri *THE ORIGINAL WATER REMOVER*



MASTER SPONGE ROLLER

- 36" wide roller is made of tough durable polyvinyl alcohol (PVA) foam
- Designed to push water off your court surface
- Anodized aluminum handle with stainless steel, black powder coated T-socket
- Stainless steel, powder coated frame includes all stainless steel hardware
- Replacement rollers include end caps

MTRDMSTR Complete Unit \$129⁹⁹ EA ★
MTRRTBLU Master Replacement Roller \$74⁹⁹ EA ★



STAINLESS STEEL T-SOCKET

ROL-DRI® SEAMLESS SPONGE ROLLER

ROL-DRI® MASTER SPONGE ROLLER



SEAMLESS SPONGE ROLLER

- Gray seamless sponge roller is made of soft absorbent polyurethane (PU) foam - 36" Wide
- Designed to absorb and push water from your court surface
- Anodized aluminum handle with stainless steel, black powder coated T-socket
- Stainless steel powder coated frame includes all stainless steel hardware
- Can also be used on damp grass to improve field conditions
- Replacement rollers include end caps

MTRDSMLS Complete Unit \$119⁹⁹ EA ★
MTRRSL36M2 Seamless Replacement Roller \$59⁹⁹ EA ★

REPLACEMENT PARTS/ACCESSORIES

- Set includes: handle, hard poly grip, stainless steel T-bracket, hanging clip, and screws
- All hardware is stainless steel

MTHDLASM Handle Assembly Set \$64⁹⁹ EA ★

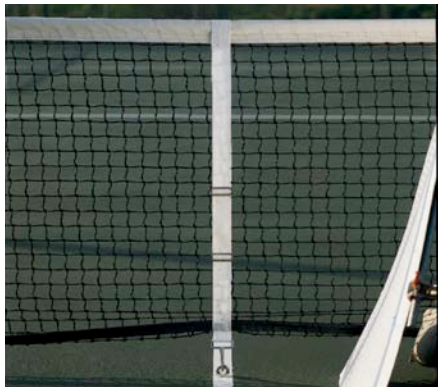

POLYESTER CENTER STRAP

- All polyester center strap
- Complete with all hardware to attach strap to net
- 5 Year Limited Warranty

1158267 \$19⁹⁹ EA ★

MacGregor CENTER STRAP

- 100% nylon center strap
- 100% synthetic nylon webbing

MTCSTRAP \$19⁹⁹ EA ★

GROUND ANCHOR

- Heavy duty zinc plated ground anchor

1234466 \$17⁹⁹ EA ★

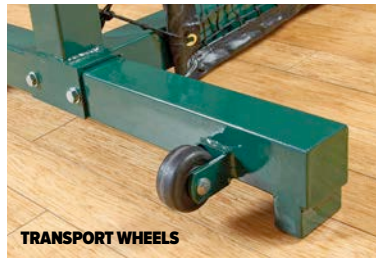

TRANSPORT WHEELS



STEEL WINDER



FREE-STANDING TENNIS SYSTEM

- Made of 3" powder coated square steel with stainless steel winder
- Includes three joining bars
- Transport wheels on each standard
- Net not included with system (See p. 223 for options)
- Indoor/Outdoor use

1244205

310 lbs.

\$1,499⁹⁹ SET ★ **SALE**

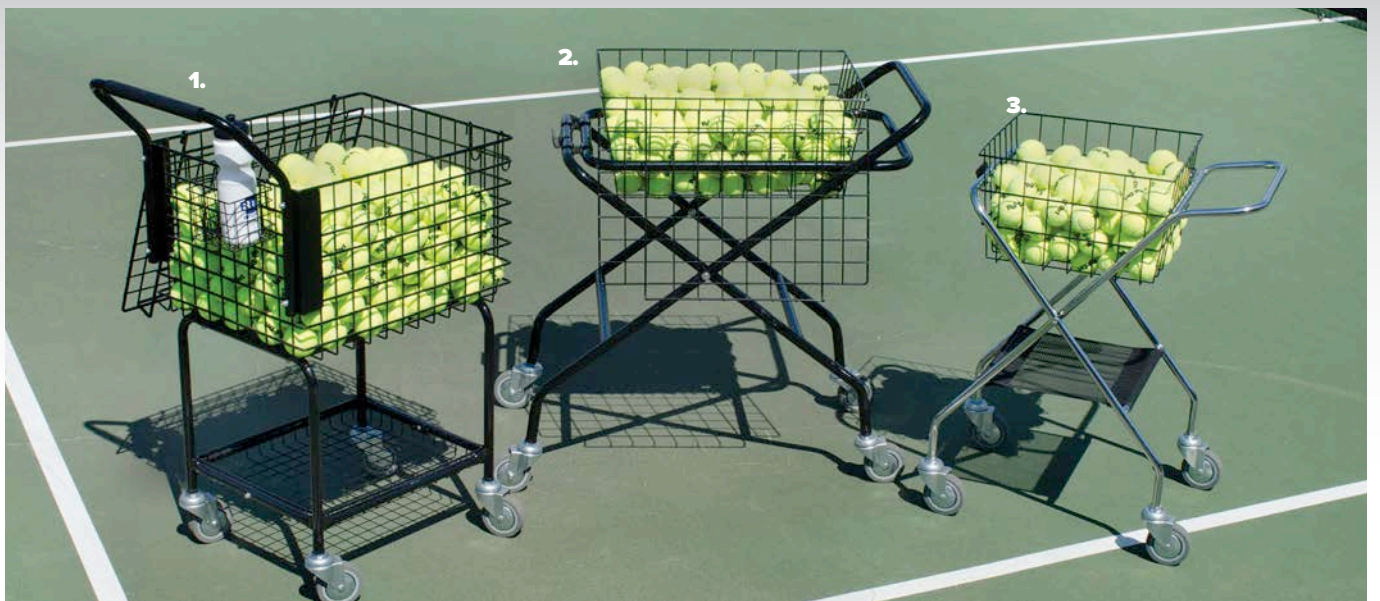

1. DELUXE TEACHING CART

- Powder coated steel frame, vinyl coated basket with foam grip
- Rubber 4" wheels with sealed ball bearings
- Locking lid that lays flat against the side
- Includes basket hanger and convenient water bottle holder
- Holds 325 tennis balls
- Basket Height - 42 1/2"H
- Top Basket - 19" W x 23"L

1342550 \$479⁹⁹ EA ★

2. FOLDABLE TEACHING CART

- Powder coated steel frame, vinyl coated basket with foam grip
- Folds easily for storage and transportation
- 4" rubber wheels with sealed ball bearings
- Lockable lid
- Includes basket hanger
- Holds 250 tennis balls
- Basket Height - 38"H
- Basket size - 20"W x 30"L

1342543 \$449⁹⁹ EA ★

3. MINI TEACHING CART

- Chrome steel construction with removable basket
- Folds easily for storage and transportation
- 4" smooth rolling rubber wheels
- Includes mesh bottom storage tray and convenient basket hanger on front of cart
- Hold 150 tennis balls
- Basket height - 34"H
- Basket size - 18"W x 25"L

1369476 \$329⁹⁹ EA ★

85 BALL RETRIEVER

- Heavy duty wire construction
- 32"H - 5 lbs.

MTRETRIE \$66⁹⁹ EA



70 BALL RETRIEVER

- Heavy duty wire construction
- Handles flip over to create stand for ball dispensing
- 32"H - 6 lbs.

MTINSTRU \$69⁹⁹ EA

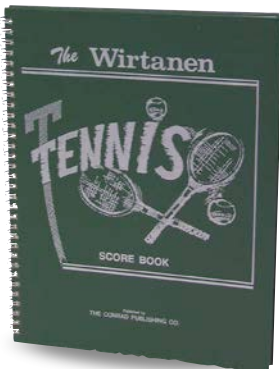
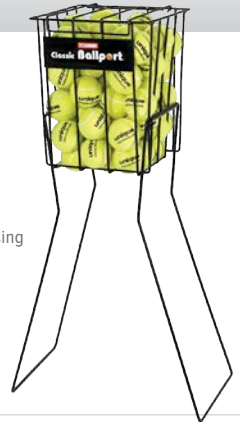

WIRTANEN TENNIS SCOREBOOK

- Includes: 32 matches, summary sheets, tournament charts, individual player records and instructions.

1303254 \$30⁹⁹ EA ★



QUICK-MARK BOUNDARY MARKERS

- Create boundaries quickly and easily
- Poly-vinyl, non-skid markers
- Includes (20) 12 1/2"L x 2"W lines and (4) 12" corners

Lifetime Warranty
Color Options: **Orange.**

45085 \$199⁹⁹ SET OF 24 ★



ROLL OUT LINE

- Use in place of floor tape
- Vinyl roll will lay flat on a gym floor, outside on the playground or anywhere you need a temporary boundary/court line
- 33"L x 3"W x 1/8" thick

1292138 \$84⁹⁹ EA ★



TUFFY® WINDSCREEN

- The toughest, highest quality windscreen in the world
 - Made with exclusive Vipol® Matrix 10 oz. material, a super-durable mesh fabric of tightly woven micro fibers
 - Offers more sun UV resistance, is virtually tear proof, and has the highest puncture and tear resistance
 - Allows 22% wind pass-through - 78% shade factor
 - Tuffy is the only windscreen featuring LOCK-STITCH finishing to assure that it's sides and corners do not unravel
 - Fully sun UV and mildew inhibitor protected
 - Grommeted every 12" on all 4 sides
 - 9' model complete with half moon vents and a grommet strip line
- 5 Year Limited Warranty**

Without Printing

1323566	up to 5'H	\$1.99	SQ.FT
1285598	6'H	\$2.49	SQ.FT
1285604	9'H	\$2.99	SQ.FT

With Chroma-Bond® Digital Imprinting

1452960	up to 5'H	\$10.99	SQ.FT
1452961	6'H	\$10.99	SQ.FT
1452962	9'H	\$10.99	SQ.FT

TUFFY® WINDSCREEN ACCESSORIES

1298253	Boxed Air Vent	\$19.99	EA
MITWRAPS	7" Tie Wraps (50 lbs. brk strength - pk of 100)	\$52.99	PACK





QUALITY • DURABILITY • CRAFTSMANSHIP



BSN SPORTS

POLYESTER WINDSCREEN

- 8oz. weight/sq. yard construction, 84% shade factor, maximum UV protection
- Custom cut to any size
- Brass tooth grommets spaced every 18" on all four sides
- IncrediSeal - eliminates all sewing and stitching
- 9' comes standard with lacing lip and half moon vents
- Match school logos exactly-digitally printed directly from your image file
- State of the art digital printing with unlimited color options

Without Printing

1393784	up to 5'H	\$1.23	SQ.FT
1393785	6'H	\$1.27	SQ.FT
1393786	9'H	\$1.29	SQ.FT

With Printing

1398129	up to 5'H	\$7 ⁴⁹	SQ.FT
1398130	6'H	\$7 ⁴⁹	SQ.FT
1398131	9'H	\$7 ⁴⁹	SQ.FT



POLY AND ARMORMESH WINDSCREEN ACCESSORIES

1397737	Boxed Vent	\$19 ⁹⁹	EA
1397738	Lacing Lip	\$0.10	EA
MTTWRAPS	7" Tie Wraps (50 lbs. brk strength - pk of 100)	\$52 ⁹⁹	PACK



ARMORMESH WINDSCREEN

- Features 14 oz. woven, extrusionvinyl-coated polyester
- Excellent tear strength and outstanding abrasion resistance
- Fabricated with IncrediSeal technology
- 75% shade factor
- Lacing lip and half moon vents standard on screens over 6'
- Match school logos exactly-digitally printed directly from your image file
- State of the art digital printing with unlimited color options

Without Printing

1393787	up to 5'H	\$1.17	SQ.FT
1393788	6'H	\$1.23	SQ.FT
1393789	9'H	\$1.29	SQ.FT

With Printing

1398132	up to 5'H	\$8 ⁴⁹	SQ.FT
1398133	6'H	\$8 ⁴⁹	SQ.FT
1398134	9'H	\$8 ⁴⁹	SQ.FT





TIDI-COOLER STAND SET

- Includes: stand, trash can, 5 gallon Igloo® cooler, and cup dispenser

1263244	Black Stand with Green Cooler	\$349⁹⁹	SET ★
1263251	Black Stand with Yellow Cooler	\$349⁹⁹	SET ★
1255669	Green Stand with Green Cooler	\$349⁹⁹	SET ★
1255676	Green Stand with Yellow Cooler	\$349⁹⁹	SET ★



TIDI-COOLER STAND

- 100% lightweight, rust free aluminum with powder coated finish
- Wide stance base for more stability
- Includes Tidi-Court basket and security cable with keyed lock to keep lid and cooler secure to stand
- Designed for 5 gallon coolers
- Cooler sold separately

1255652	Green Stand & Basket	\$299⁹⁹	EA ★
1263268	Black Stand & Basket	\$299⁹⁹	EA ★



WATER COOLER

- Rugged, durable 400 series industrial strength water coolers with Ultratherm™ insulation keeps water ice cold
- UV Protection prevents surface from chipping, peeling, or rusting
- FDA approved white inner liner is easy to clean and resists stains
- Lid cord attached to prevent loss
- Optional cup dispenser holds approximately 200 (4 or 4.5 oz.) cups-not included



MSIGLO5X	Yellow - 5 Gal.	\$89⁹⁹	EA
MSIGLO10	Yellow - 10 Gal.	\$129⁹⁹	EA
1263220	Green - 5 Gal.	\$109⁹⁹	EA
1263237	Green - 10 Gal.	\$149⁹⁹	EA
1376916	Orange - 5 Gal. Seat Top	\$84⁹⁹	EA
1384468	Orange - 10 Gal. Seat Top w/Cup Dispenser	\$139⁹⁹	EA
MSCUPDIS	Optional Cup Dispenser	\$42⁹⁹	EA
1384470	4.25 oz. Cone Cup - 5000/Case	\$269⁹⁹	EA



TIDI-COURT

- Empty your pockets, store your drink cups and cans and keep trash where it belongs with the Tidi-Court
- Uses a simple hose clamp attachment to fit any shape or size post

TNVALET	Green	\$72⁹⁹	EA ★
TNVALETB	Black	\$72⁹⁹	EA ★

Replacement Basket

- Handy replacement basket keeps trash where it belongs...off your court

TNKPRBSK	Green	\$44⁹⁹	EA
TNKPRBSKB	Black	\$44⁹⁹	EA

Replacement Tray

- Convenient valet tray for storing valuables during play

TNKPRTRY	Green	\$32⁹⁹	EA
TNKPRTRYB	Black	\$32⁹⁹	EA

Replacement Clamp

- Hose clamp attachment to fit any shape or size post

TNKPRCLP		\$14⁹⁹	EA
-----------------	--	--------------------------	----

TENNIS SCORE TUBE™

- Use tennis balls to keep score
- PVC tube with holes to indicate set score
- A stainless steel hose clamp is supplied to secure to post or net
- Hooks are supplied for fence mounting
- Color Options: **Black, Blue, Green, White.**



1296099	Specify Color	\$59⁹⁹	EA
----------------	---------------	--------------------------	----

QUICKSCORE

- Portable scorecard that sits on top of the net.
- Includes both game & set scores.
- Contains game numbers up to 7 to allow scoring for regular as well as pro sets



1274219	Set of 4	\$299⁹⁹	SET
----------------	----------	---------------------------	-----



QUICKSTART ROLL-A-NET

- Adjusts from tennis height up to badminton height
- Weather-resistant polyester paint to help avoid rusting with outdoor use
- Easily wheels on and off the court with locking wheels
- Center support wheel with adjustable net tension
- Net rolls up easily and stores in nylon bag with wheels

1377091

\$449⁹⁹ EA

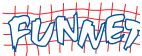

PORTABLE NET SYSTEM

- Portable net system for a variety of games and activities
- Ideal for beginning tennis, badminton & volleyball
- Height adjustable from 32" to 52"
- Comes complete with carrying case



1282450	10'L Model	\$189 ⁹⁹ EA ★
1282467	18'L Model	\$219 ⁹⁹ EA ★

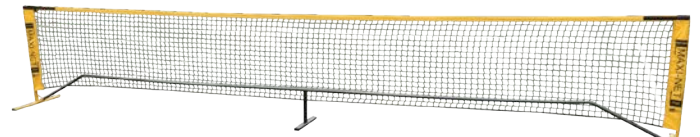

QUICKSTART MINI AND MAXI NET SYSTEMS

- Portable net systems for a variety of activities and lead-up games, including tennis, badminton and beginner volleyball
- Nets are easy to set up and take down in 2 minutes or less without tools
- Constructed of durable oval metal tubing
- Mini Net adjusts from 30" - 52" high
- Maxi Net adjusts from 30" to 64" high
- Comes complete with carrying case
- Not intended to be left outside for extended periods of time

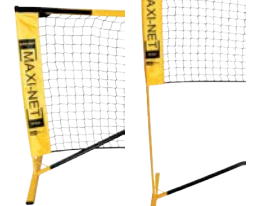

Mini Net

Maxi Net with extensions

20025187	Mini Net - 10'L	\$219 ⁹⁹ EA
20021837	Maxi Net - 18'L	\$239 ⁹⁹ EA



RACQUET CART

- Galvanized steel construction
- Holds up to 64 tennis rackets or 100 table tennis paddles
- Non-marring casters for easy transport

1690XXXX	32"L x 14"W x 28"H	\$129 ⁹⁹ EA ★
-----------------	--------------------	--------------------------



RACQUET CART

- Stores and transports up to 100 racquets and paddles of all types
- Transport all your badminton or tennis equipment in one trip
- Features a basket for storing tennis balls, shuttlecocks and other accessories

1246131	41"H x 43"W x 19"D	\$479 ⁹⁹ EA ★
----------------	--------------------	--------------------------



Penn

CHAMPIONSHIP TENNIS BALLS

• Can of 3 balls - 24 Cans/Case

MTPENCAN

\$9⁹⁹ CAN



Penn

PRACTICE/COACH TENNIS BALLS

• Can of 3 balls - 24 Cans/Case

MTPENBAL

\$8⁹⁹ CAN



DUNLOP

CHAMPIONSHIP TENNIS BALLS

• Can of 3 balls - 24 Cans/Case

MTDUNCAN

\$11⁹⁹ CAN



Wilson

CHAMPIONSHIP TENNIS BALLS

• Can of 3 balls - 24 Cans/Case

MTWILCAN

\$10⁹⁹ CAN



RolDri

PRESSURELESS TENNIS BALLS

• Perfect for practice or recreational tennis

1704XXXX

\$21⁹⁹ DZN ★

WHAT IS 10 & UNDER TENNIS? (Formerly Quickstart Tennis)

10 & Under Tennis is a program designed to help kids 10 years old and under learn to play the game of tennis. A few changes have been made to encourage learning the game.....The court sizes. The racquet sizes. The ball sizes. The scoring system. Also, the net height. 10 & Under is now part of the USTA Jr. Tennis league and can be a part of every development program. More kids will be able to enjoy this new format and have lots of fun playing with their friends.

AGE	COURT SIZE	RAQUET	BALL	NET HEIGHT	SCORING
8 yrs & under	36' x 18'	up to 23"	foam or very low compression	2' 9"	-Best 2 out of 3 games -Games to 7 points
10 yrs & under	60' x 21' singles 60' x 27' doubles	up to 25"	low compression	3'	-Best 2 out of 3 sets -Games to 7 points -4 Games = Set -3rd Set Tiebreaker to 7 points



Penn

QST 60 BALLS

- Low compression core
- High visibility felt, greater control for longer rallies
- ORANGE Ball for 60' tennis court size
- Recommended for ages 9 & 10

1451699

Dozen

\$32⁹⁹ DZN



Penn

CONTROL PLUS BALLS

- 25% reduced speed for greater control
- Premium high visibility felt for exceptional durability
- GREEN Dot ball for standard 78' tennis court size
- Meets all specifications for the USTA "10 and Under" Tennis ITF "Play+Stay" programs
- Recommended for ages 11+

1451700

Dozen

\$35⁹⁹ DZN



Penn

QST 36 FELT BALLS

- Low compression core with durable felt
- Modified speed and bounce for greater control
- Ideal for driveway play and outdoor courts
- Red Ball for 36' tennis court size
- Recommended for ages 8 & Under

1451698

Dozen

\$31⁹⁹ DZN

MacGregor

**BEST
SELLER**



WIDE BODY SERIES

- Graphite & aluminum fused head and shaft
- O-Beam frame design with PU grip
- Over-size 110 square inch head
- Available in 4 1/4", 4 3/8" or 4 1/2" grip size

1393403	27"L - 4 1/4" Grip (Green/White)	\$38 ⁹⁹ EA ★
1393404	27"L - 4 3/8" Grip (Blue/White)	\$38 ⁹⁹ EA ★
1393405	27"L - 4 1/2" Grip (Red/White)	\$38 ⁹⁹ EA ★



RECREATIONAL SERIES

- Graphite & aluminum fused head and shaft
- O-Beam frame design with PU grip
- Mid-size 95 square inch head
- Available in 4 3/8" or 4 1/2" grip size

1393401	27"L - 4 3/8" Grip (Orange/Black)	\$34 ⁹⁹ EA ★
1393402	27"L - 4 1/2" Grip (Green/Black)	\$34 ⁹⁹ EA ★



YOUTH SERIES

- Graphite & aluminum fused head and shaft
- O-Beam frame design with PU grip
- Mid-size 95 square inch head
- Available in 21", 23" & 25" length

1393406	21"L - 4" Grip (Black/Yellow)	\$31 ⁹⁹ EA ★
1393407	23"L - 4" Grip (Black/Orange)	\$31 ⁹⁹ EA ★
1393408	25"L - 4" Grip (Black/Silver)	\$31 ⁹⁹ EA ★



Wilson PRO PRECISION XL

- 11.5oz sq in head
- AirLite alloy construction creates lightweight frame with power and durability
- 4 3/8" grip size

WLWR080310U3	27.25" L	\$47 ⁹⁹ EA
---------------------	----------	-----------------------



HEAD[®] TI RADICAL ELITE

- Composite construction for added control and spin
- Oversized Head 105" for controlled power at moderate to full swing speed
- Controlled cushion for maximum comfort
- 4 3/8" grip size

1460803	27" L	\$49 ⁹⁹ EA
----------------	-------	-----------------------



Wilson ENERGY XL

- V-Matrix[™] Technology for larger sweet spot
- 10.3 oz strung weight(291g)
- 4 3/8" grip size

1388070	27.5" L	\$41 ⁹⁹ EA
----------------	---------	-----------------------

TOURNAGRIP PRO PACK-10 GRIPS

- Extremely durable and well cushioned for maximum comfort and performance
- Use with all tennis, badminton, squash and racquetball racquets
- Comes in a package of 10 to grip 10 racquets



1463990	\$34 ⁹⁹ PACK
----------------	-------------------------



HEAD[®] SPEED JR

- Speed racquets are endorsed by top ranked ATP Players
- Perfect for learning at any age
- Bumper guard for added durability
- Official racquet of the UTSA School Programs

1460805	25" L	\$34 ⁹⁹ EA
----------------	-------	-----------------------



HEAD[®] TOUR PRO

- Nano Titanium technology provides added power and stability
- Super Oversized 110" head for a maximum sweetspot and extra power
- 4 3/8" grip size

1460804	27" L	\$39 ⁹⁹ EA
----------------	-------	-----------------------

PORTABLE BADMINTON GAME STANDARDS

- 2 3/8" OD Flo-coated® galvanized standards
- 24"D steel base with rubber floor protector
- Roll-away wheels, no floor plates necessary
- Includes economy badminton net
- Blue only
- Includes Pickleball settings

STBMNSTD 160 lbs. **\$1,099⁹⁹** PR ★

PROTECTIVE BASE PAD

- Vinyl covered bonded foam
- Easy to install with hook-and-loop attachments
- Blue only

1012385 **\$219⁹⁹** EA ★

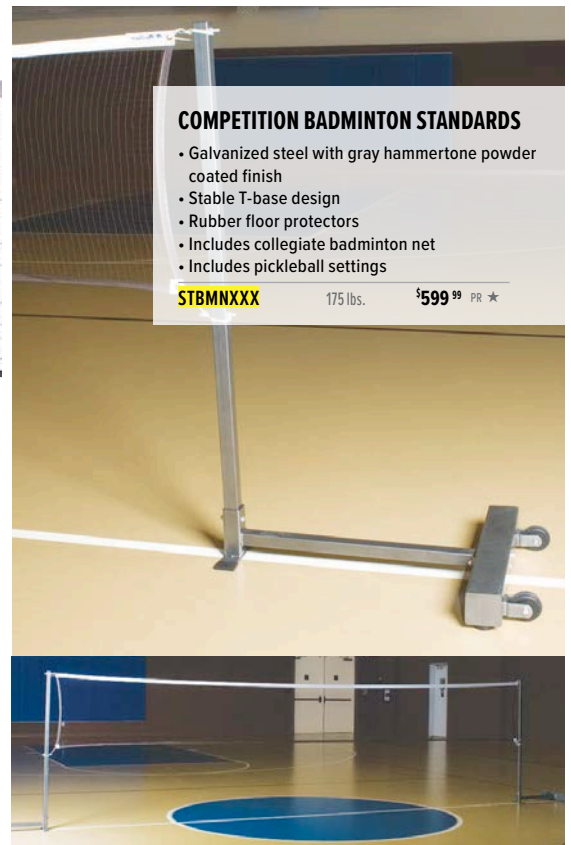

COMPETITION BADMINTON STANDARDS

- Galvanized steel with gray hammertone powder coated finish
- Stable T-base design
- Rubber floor protectors
- Includes collegiate badminton net
- Includes pickleball settings

STBMNXXX 175 lbs. **\$599⁹⁹** PR ★

Gold Medal **BADMINTON NETS**

CODE	MODEL	USE	NET	HEADBAND	CABLE	BOTTOM & SIDETAPES	PRICE
MACBMNET	PROFESSIONAL 21' x 2.5'	Competition	Weather treated knotless nylon	White HD vinyl	1/4" poly rope	Vinyl coated nylon	\$69⁹⁹ EA ★
SNBMNCOL	COLLEGIATE 21' x 2.5'	Intramurals	3/4" mesh nylon	Vinyl coated nylon	Braided nylon - 4mm	Double stitched nylon	\$59⁹⁹ EA ★
SNBMN128	ECONOMY 21' x 2.5'	Recreational	Knotted poly- fiber 3/4" mesh	PVC Vinyl 3mm braided nylon	Braided nylon - 3mm	Single stitched vinyl	\$49⁹⁹ EA ★



MacGregor TOURNAMENT SHUTTLECOCKS

- Medium speed with nylon feathers and cork tip
- Sold in tubes of 6

1. **MSBIRDNY** White **\$19⁹⁹** SET OF 6 ★
 2. **MSBIRDYL** Yellow **\$19⁹⁹** SET OF 6 ★

ECONOMY SHUTTLECOCKS

- White, plastic feathers with rubber tip

3. **MSBIRDPL** **\$17⁹⁹** SET OF 36 ★
MSBIRDPG **\$69⁹⁹** SET OF 144 ★



BADMINTON SET

- Includes: 4 nylon strung tempered steel racquets, 1"D steel poles, 2 ground sleeves, 2 shuttlecocks, 2 1/2'H x 20'L net and carry bag

1651XXXXY **\$59⁹⁹** SET ★



CHAMP

- Graphite and aluminum fused head and shaft
- Nylon close string with PU grip
- Strung weight: 93 grams
- Length: 26"

1393409 \$25⁹⁹ EA ★



TOURNAMENT 110

- Graphite and aluminum fused head and shaft
- Nylon close string with PU grip
- Strung weight: 110 grams
- Length: 26"

1393410 \$23⁹⁹ EA ★



TWIN 200

- Graphite and aluminum fused head and twin shaft
- Nylon close string with PU grip
- Strung weight: 110 grams
- Length: 26"

1393411 \$21⁹⁹ EA ★



ECONOMY YOUTH

- Graphite and aluminum fused head and shaft
- Nylon close string with PU grip
- Strung weight: 130 grams
- Length: 25"

1393412 \$20⁹⁹ EA ★



ONE-PIECE BADMINTON RACQUET

- One-piece molded racquet
- Lightweight flexible design
- Weight: 130 grams
- Length: 25 1/2"

MSRA02YT \$24⁹⁹ EA



Wilson MATCHPOINT

- Two piece aluminum frame and flared inside grommets for maximum durability
- Oversized 53 square inch sweet spot
- Strung weight: 120 grams
- Length: 26"

1310122 \$24⁹⁹ EA



SONIC TI 5.0

- Alloy construction
- Weight: 195g
- Head Size: 500sq cm

1458973 27" L \$59.99 EA

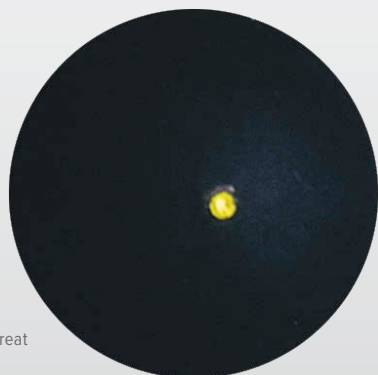

COMPETITION SQUASH BALL

- Ball provides great performance and great value for club and intermediate play
- Standard size with a 10% longer hang-time to that of the Dunlop Pro Squash Ball.

1371547 Dozen \$64.99 EA



SONIC LITE TI 5.0

- Sonic Lite TI is a perfect racquet for beginner and recreational player
- Balanced racquet that weighs 6.8oz

1464760 27" L \$59.99 EA



HEAD

IMPULSE

- Ultra lightweight design with adjustable strap
- Anti-fog treated with shatterproof polycarbonate lenses

1238983 \$16.99 EA



USHA 21[®] HANDBALL

- Exclusively USHA endorsed
- 1 ball per can

1553XXXX \$19.99 CAN

Penn

PRO GREEN RACQUETBALL

- The official ball of USA Racquetball makes the Pro Penn the most widely used ball in tournament play.
- Bright green color has a great on-court visibility.
- Consistent speed, playability and durability

1556XXXX Can of 3 **\$9⁹⁹** CAN

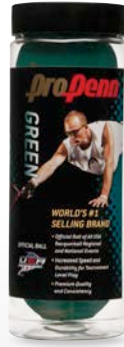

12-BALL CANISTER

- The world's #1 selling racquetball
- Ultra blue color offers added visibility
- Ideal for all levels of play

1238976 **\$34⁹⁹** CAN

12
BALLS
PER CAN



HIGH DEFINITION RACQUETBALL

- Penn's new HD High Definition racquetball.
- Optimum on-court visibility
 - Faster, livelier and consistent playability
 - Lighter weight for a more comfortable feel
 - Increased durability

1557XXXX Can of 3 **\$9⁹⁹** CAN

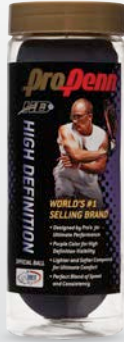

ULTRA BLUE RACQUETBALL

- The World's #1 Selling Racquetball
- Ultra blue racquetball gives long, lively, and consistent play
- Microscopic texturization for extra bite

1555XXXX Can of 3 **\$8⁹⁹** CAN



MacGregor



SCHOLASTIC

- Powder coated aluminum O-Beam frame
- Tear drop head with built-in bumper
- Open throat design
- Soft 4" PU grip
- Strung weight: 210 grams

1393414 22"L **\$34⁹⁹** EA ★



COLLEGIATE

- Tear drop head with aluminum O-Beam frame
- Built-in bumper with open throat design
- Soft 4" PU grip
- Strung weight: 210 grams

1393413 22"L **\$37⁹⁹** EA ★

HEAD



MX CYCLONE

- Metallix alloy provides a stronger, lighter, stiffer and more powerful construction
- Pyramid V PowerZone String Pattern
- Head Size 106.5 sq. in. - Grip Size 3-5/8"
- Weight - 190 grams

1459273 22"L **\$49⁹⁹** EA



PORTABLE PICKLEBALL NET

- 34"H x 22"W
- Meets USAPA requirements
- Premium carry bag with wheels for easy transportation

90 Day Limited Warranty

1454847

\$199⁹⁹ EA



EQUIPMENT



THE RECRUIT STARTER SET

- Perfect for those pickleball players eager to get out on the court and learn the sport
- Kit includes: 2 hardwood paddles and 2 pickleballs

90 Day Limited Warranty

1393481

\$49⁹⁹ SET



THE RECRUIT 1.0 PADDLE

- A recreational, 6-ply bass wood pickleball paddle that features a stained-wood face and a blue handle
- Perfect for the beginner player looking for a solid-feeling pickleball paddle

90 Day Limited Warranty

1393482

\$27⁹⁹ EA



THE RECRUIT 2.0 PADDLE

- A recreational, 7-ply baltic birch wood pickleball paddle that features a padded grip on the handle
- Provides a solid feel and long-lasting durability for entry-level players

90 Day Limited Warranty

1393483

\$35⁹⁹ EA



THE COMPOSITE STRYKER

- Perfect for players looking to trade up from a wood paddle to a composite
- Offers the lightweight playability of a nomex core with the power of a fiberglass face

Color Options: Blue, Green, Red.

1460906

Specify Color

\$99⁹⁹ EA



THE GRAPHITE Z5

- The top selling paddle in the Onix line
- Offers the premium, lightweight playability of a graphite face and increased control of a nomex core

Color Options: Blue, Green, Orange, Pink, Purple, Red, White, Yellow.

1460898

Specify Color

\$113⁹⁹ EA

BALLS



X-40 OUTDOOR PICKLEBALLS

- Meets USA Pickleball approved requirements for outdoor tournament pickleball play
- 40 precisely drilled holes create a balanced consistent flight pattern
- High quality pigments keep the ball visible in various outdoor lighting conditions to help improve accuracy

1460806

Optic Yellow-12 Pack Box

\$49⁹⁹ PACK

1460807

Optic Yellow-100 Pack Box

\$269⁹⁹ PACK



ECLIPSE

- The Champion Eclipse Paddle is USAPA approved and weighs a trim 7.3-7.8 oz.
 - Small grip circumference allows it to be handled by players of any size and has cushioned grip that reduces vibration from impact.
 - Handle length is 5".
 - Slim guard to make the most out of the paddles 7 3/4" wide surface
- Color Options: **Blue/Green, Red/Yellow.**

1460994 Specify Color \$49⁹⁹ EA



GRAPHITE X

- The Champion Graphite X Paddle is a colorful model that offers lots of surface area and a responsive gentle feel.
 - Graphite X paddle has a weight range of 7.6-7.8 oz and has a medium circumference grip with perforations to keep sweat away from your hand.
 - The graphite face is great for controlling your placement and the polymer core adds durability and strength.
- Color Options: **Blue, Grey, Purple, Red.**

1460997 Specify Color \$89⁹⁹ EA



PICKLEBALL NET

- Official pickleball height (34") and width (22") net
- Portable, powder-coated steel frame net system
- Center-strap design for consistent height
- Adjustment straps on net edge for excellent net tension
- Fast and easy assembly, with nylon storage bag

1363633 \$229⁹⁹ EA



PICKLEBALL. GREAT FOR ALL AGES!



DILLER PADDLE

- Lightweight 7-ply maple wood paddle with wrapped handle and safety wrist strap
- From the company that invented the game
- A top choice for recreational and institutional play

1450225 \$19⁹⁹ EA



DILLER PADDLE & BALL PACK

- The Ultimate Starter Kits!
- Durable maple wood pickleball paddles with wrapped grip, safety strap and pickleballs

1450226 2 Paddles + 4 Balls \$32⁹⁹ PACK

1450227 4 Paddles + 4 Balls \$55⁹⁹ PACK



DILLER NET SET

- A complete pickleball set for those who have existing net stanchions
- Includes a durable tie-on net (22'L), 4 Diller paddles, 4 pickleballs and a rules/strategy sheet

1024XXXX \$232⁹⁹ SET



3.0 TOURNAMENT NET & FRAME SET WITH DILLER WOOD PADDLES

- This tournament set includes everything you need to get started playing pickleball
- Includes portable, regulation-size metal frame and net, 4 Diller paddles, 4 pickleballs, carrying bag and rules guide

90 Day Limited Warranty

1364661 \$299⁹⁹ SET



PICKLEBALL INC.

PORTaPiT®

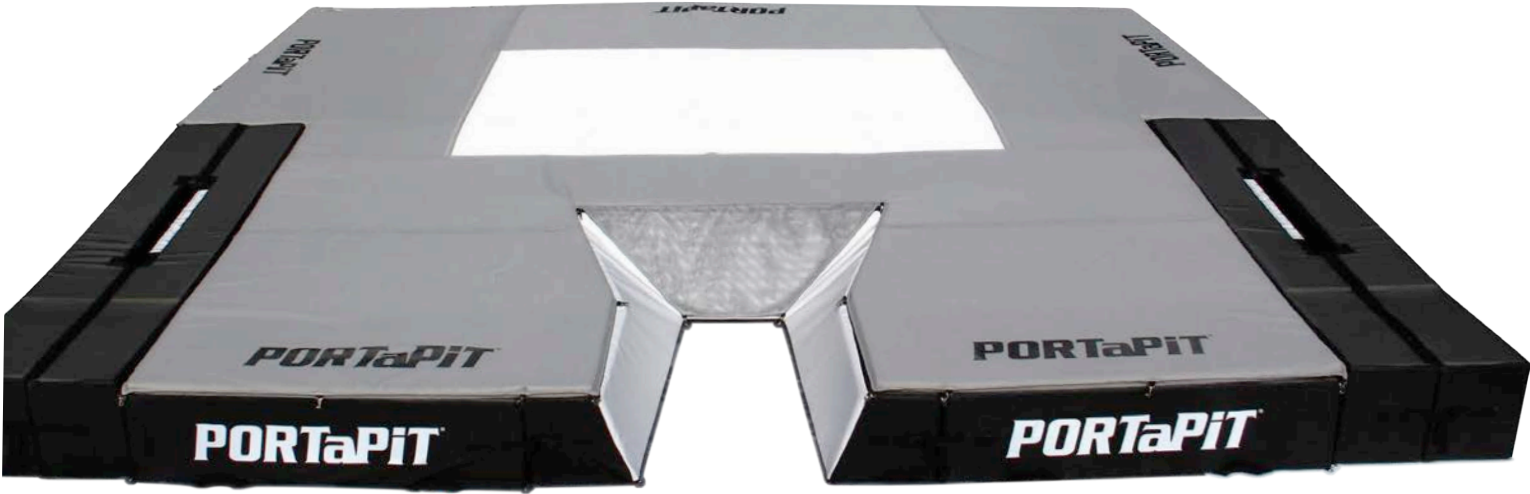

COMPETITION POLE VAULT LANDING SYSTEM

- Exceeds all High School specifications
- 22'W x 22'L, Pit has 16' 6"D of landing area behind the vault box
- Includes 2" top pad
- Base protector pads sold separately
- Includes 10'W x 8'D coaches box
- All pits made to order with 6-8 week lead time

OPTIONAL ITEMS

• Base Protector Pads (Required)

Competition Pole Vault Landing Systems

GP2222X32	Size: 22"W x 22"L x 32"H	\$21,999 ⁹⁹ EA ★
GP2222X28	Size: 22"W x 22"L x 28"H	\$20,999 ⁹⁹ EA ★
GP2222X26	Size: 22"W x 22"L x 26"H	\$19,999 ⁹⁹ EA ★
GTP2222YDS	Replacement Top Pad	\$4,299 ⁹⁹ EA ★

Weather Cover

GWC2222X32	32"	\$2,399 ⁹⁹ EA ★	
GWC2222X28	28"	\$2,399 ⁹⁹ EA ★	
GWC2222X26	26"	\$2,399 ⁹⁹ EA ★	

Base Protector Pads

STPADCNTL32	32"W x 130"L	\$3,699 ⁹⁹ PR ★	
STPADCNTL28	28"W x 130"L	\$3,699 ⁹⁹ PR ★	
STPADCNTL26	26"W x 130"L	\$3,699 ⁹⁹ PR ★	

PORTaPiT
LANDING SYSTEMS
AVAILABLE IN:





SCHOLASTIC POLE VAULT LANDING SYSTEM

- Exceeds High School NFHS specifications
- 20'W x 21'L, Pit has 16' 6" of landing area behind the vault box
- Includes 2" top pad
- Includes 10'W x 8'D Coaches Box
- All pits made to order with a 6-8 week lead time

OPTIONAL ITEMS

• Base Protector Pads (Required)

Scholastic Pole Vault Landing Systems

GP2021X28	Size: 20"W x 21"L x 28"H	\$18,999 ⁹⁹	EA ★	
GP2021X26	Size: 20"W x 21"L x 26"H	\$16,799 ⁹⁹	EA ★	
GTP2021YDS	Replacement Top Pad	\$3,699 ⁹⁹	EA ★	

Weather Cover

GWC2021X28	28"	\$2,099 ⁹⁹	EA ★
GWC2021X26	26"	\$2,099 ⁹⁹	EA ★

Base Protector Pads

STPADCTR28	28"W x 107"L	\$2,899 ⁹⁹	PAA ★	
STPADCTR26	26"W x 107"L	\$2,899 ⁹⁹	PR ★	



GRAPHICS FOR TOP PADS

- Full color image of your mascot or school name in the center of your top pad
- Please send camera ready art work along with your order and we will a copy of your design for approval
- Please allow an add'l 2 weeks for graphics on a pit order

1459233 Size 6' x 6', for PV or HJ \$359⁹⁹ EA ★

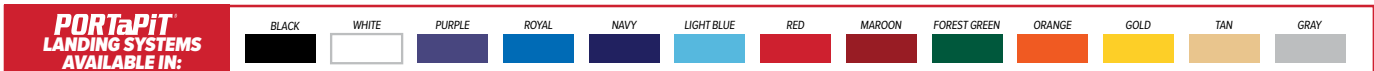

GILL™ ATHLETICS

ESSENTIALS

- All steel tubing construction
- Height adjustment 6' to 16' reading both English and Metric
- Upright detaches for base rails for storage
- 75mm bar rest pins and 8 base anchors included
- Meets NFHS specifications

GA7100 \$2,349⁹⁹ EA



SCHOLASTIC

- Heavy duty aluminum uprights and rises with custom glide parts
 - Weighted steel base includes wheels
 - Height scales read in English and Metric from 7' to 18'
 - Meets NFHS and NCAA specifications
- 10 Year Limited Warranty**

GA77100 \$3,999⁹⁹ SET

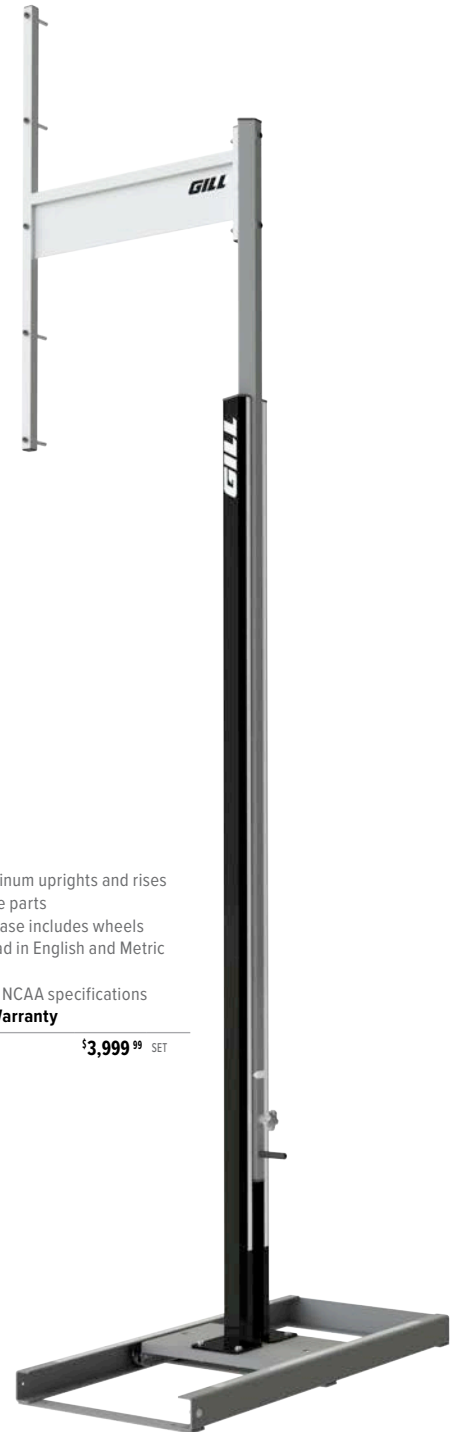

ELASTIC CROSSBAR

- Elastic practice crossbar with black foam
- Fits both high jump and pole vault

AFR050BM \$49⁹⁹ EA



SAFETY MAX VAULT BOX COLLAR

- Provides additional protection by padding exposed hard surfaces
- Fully compliant with ASTM Standard F2949
- Safety yellow color helps highlight open area for planting and vaulting
- SafetyMax will work with any style of pole vault landing system
- Vault Box is not included with the collar

GA719 \$949⁹⁹ EA 



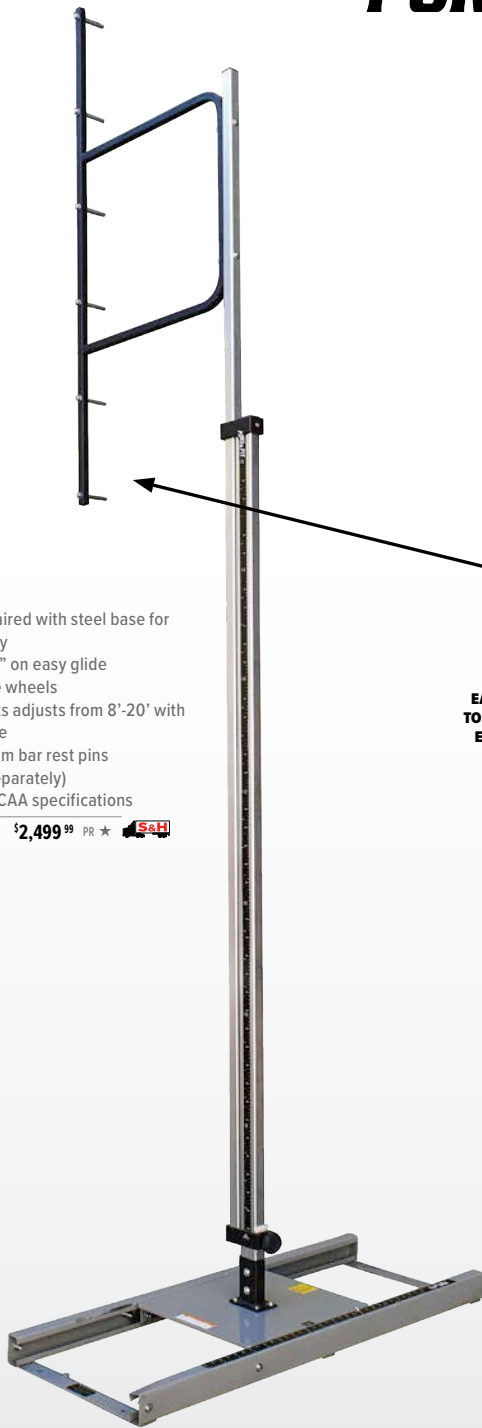

ELITE

- Aluminum upper paired with steel base for exceptional stability
- Base adjusts 0"-32" on easy glide polyurethane skate wheels
- Detachable uprights adjust from 8'-20' with English/Metric scale
- Equipped with 75mm bar rest pins (55mm pins sold separately)
- Meets NFHS and NCAA specifications

1378720 \$2,499⁹⁹ PR ★



EASILY ATTACHES TO STANDARDS FOR EXTRA 3' LOWER SETTINGS



COMPETITION

- Steel uprights and base are finished with silver powder coat
- Base adjusts 0"-32" on easy glide polyurethane skate wheels
- Detachable upright adjusts from 7'-18' marked with English/Metric scale
- Equipped with 75mm bar rest pins (55mm pins sold separately)
- Meets NFHS and NCAA specifications

1378660 \$1,599⁹⁹ PR ★
AFEXTEND Extenders \$112⁹⁹ PR ★
1378679 55mm Bar Rest Pins (Set of 12) \$39⁹⁹ SET ★



S&H= \$75⁰⁰ PER ORDER (Up to 3 Crossbars)

PREMIER PV CROSSBAR

- Pole is 14"10" L
- Meets Collegiate, International, and NFHS specifications
- Comes with Nofzinger feature
- 2 Year Limited Warranty

AFPV1500 \$89⁹⁹ EA ★
AFPV1503 Set of 3 \$229⁹⁹ SET OF 3 ★



XBAR PUTTER UPPER

- Fits over the end of any vaulting pole

GA710390 \$49⁹⁹ EA

POLE VAULT BOX COLLAR SYSTEM

- Cover is made with heavy duty vinyl
- Made of polyethylene foam filler to meet new ASTM F-2942-12 specifications
- Comes with four (4) in ground anchors
- Fits any pole vault landing system

1388862 \$749⁹⁹ EA ★



SEE PAGE 304 FOR VAULT BOX OPTIONS

PORTaPIT®



PREMIER HIGH JUMP LANDING SYSTEM

- Meets all High School and NCAA specifications
- Made of 18oz. knife coated polyester fabric
- Includes 2" reversible top pad
- All pits made to order with a 6-8 week lead time

12 Year Limited Warranty

GP1116X32	Size: 11' x 16'6" x 32"	\$10,399 ⁹⁹ EA ★
GWC1016X32	Weather Cover	\$949 ⁹⁹ EA
GP1116X28	Size: 11' x 16'6" x 28"	\$9,499 ⁹⁹ EA ★
GWC1016X28	Weather Cover	\$949 ⁹⁹ EA
GP1116X24	Size: 11' x 16'6" x 24"	\$8,999 ⁹⁹ EA ★
GWC1016X24	Weather Cover	\$949 ⁹⁹ EA
GTP1016XDS	Replacement Top Pad	\$2,199 ⁹⁹ EA ★



GRAPHICS FOR TOP PADS

- Full color image of your mascot or school name in the center of your top pad
- Please send camera ready art work along with your order and we will a copy of your design for approval
- Please allow an add'l 2 weeks for graphics on a pit order

1459233 Size 6' x 6', for PV or HJ \$359⁹⁹ EA ★

CODE	OVERALL SIZE	3 BASE UNITS	TOP PAD	WEIGHT
GP1016X32	11' X 16'6" X 32"	11' X 16'6" X 30"	11' X 16'6" X 2"	650 LBS
GP1016X28	11' X 16'6" X 28"	11' X 16'6" X 26"	11' X 16'6" X 2"	550 LBS
GP1016X24	11' X 16'6" X 24"	11' X 16'6" X 22"	11' X 16'6" X 2"	450 LBS

ELEMENTARY HIGH JUMP PIT

- Ideal for elementary physical education classes
- Created and designed for the younger athlete
- Meets our own rigorous safety standards
- This pit does not require a top pad

5 Year Limited Warranty

GBU24511	5'6" x 11' x 24"	\$3,799 ⁹⁹ EA ★
GBU30511	5'6" x 11' x 30"	\$4,299 ⁹⁹ EA ★



PORTaPIT® LANDING SYSTEMS AVAILABLE IN:

BLACK	WHITE	PURPLE	ROYAL	NAVY	LIGHT BLUE	RED	MAROON	FOREST GREEN	ORANGE	GOLD	TAN	GRAY
-------	-------	--------	-------	------	------------	-----	--------	--------------	--------	------	-----	------

PORTaPIT®



8'
DEPTH

24" and 28"
HEIGHT
OPTIONS

12
YEAR LIMITED WARRANTY

NEW
REVERSIBLE
TOP PAD

SCHOLASTIC HIGH JUMP LANDING SYSTEM

- Meets all High School and NCAA specifications
 - Made of 18 oz. knife coated polyester fabric
 - Includes 2" top pad
 - All pits made to order with 6-8 week lead time
- 5 Year Limited Warranty

GP0816X28	Size: 8' x 16'6" x 28"	\$7,999 ⁹⁹ EA ★
GWC0816H	Weather Cover	\$799 ⁹⁹ EA ★
GP0816X24	Size: 8' x 16'6" x 24"	\$7,499 ⁹⁹ EA ★
GWC0816M	Weather Cover	\$799 ⁹⁹ EA ★
GTP0816XDS	Replacement Top Pad	\$1,799 ⁹⁹ EA ★

CODE	OVERALL SIZE	3 BASE UNITS	TOP PAD	WEIGHT
GP0816X28	8' x 16'6" x 28"	5'6" x 8' x 26"	8' x 16'6" x 2"	550-LBS
GP0816X24	8' x 16'6" x 24"	5'6" x 8' x 22"	8' x 16'6" x 2"	450-LBS



12'
DEPTH

24" and 28"
HEIGHT
OPTIONS

12
YEAR LIMITED WARRANTY

NEW
REVERSIBLE
TOP PAD

COMPETITION HIGH JUMP LANDING SYSTEM

- Meets all High School and NCAA specifications
 - Made of 18 oz. knife coated polyester fabric
 - Includes 2" top pad
 - All pits made to order with 4-6 month production time (depending on product availability)
- 5 Year Limited Warranty

GP1218X28	Size: 12' x 18' x 28"	\$10,999 ⁹⁹ EA ★
GWC1218H	Weather Cover	\$1,249 ⁹⁹ EA ★
GP1218X24	Size: 12' x 18' x 24"	\$10,499 ⁹⁹ EA ★
GWC1218M	Weather Cover	\$1,249 ⁹⁹ EA ★
GTP1218XDS	Replacement Top Pad	\$1,899 ⁹⁹ EA ★

CODE	OVERALL SIZE	3 BASE UNITS	TOP PAD	WEIGHT
GP1218X28	12' x 18' x 28"	6' x 12' x 26"	12' x 18' x 2"	750-LBS
GP1218X24	12' x 18' x 24"	6' x 12' x 22"	12' x 18' x 2"	680-LBS

GILL™ ATHLETICS



ESSENTIALS

- All steel construction with black powder coat finish
- 18" square base with wheels
- Height scales read in English and Metric from 2' to 8'
- Meets High School and NCAA specifications

10 Year Limited Warranty

GA700 \$779⁹⁹ SET



S4 SCHOLASTIC

- Heavy duty aluminum uprights and rises with custom glide parts
- Weighted steel base includes wheels
- Height scales read in English and Metric from 2' to 7'4"
- Meets NFHS and NCAA specifications

10 Year Limited Warranty

GA78105 \$1,649⁹⁹ PR 

WOOD DECK PIT CART

- Constructed of 3/4" MDO exterior plywood
- Cart deck measures 4' x 8'
- 12" pneumatic wheels for easy maneuverability
- Deck height is 16"

GA767 \$2,369⁹⁹ EA 



ESSENTIALS CROSSBARS

- Durable fiberglass with replaceable ends, meets High School specifications

GA522	High Jump	\$119 ⁹⁹ EA
GA5223	HJ - Set of 3	\$299 ⁹⁹ EA
GA523	Pole Vault	\$119 ⁹⁹ EA
GA5233	PV - Set of 3	\$299 ⁹⁹ EA

PORTaPIT®

COMPETITION

- Steel uprights and 18" base are finished with silver powder coat
- Adjusts from 2'-8" marked with English/Metric scale
- Meets NFHS and NCAA specifications

1378658 \$579⁹⁹ PR ★



ELITE

- Aluminum uppers paired with steel base for exceptional stability
- Low profile base is equipped with wheels for easy transport
- Height adjustments for 2' - 8'6" with English/Metric scale
- Meets NFHS and NCAA specifications

1378710 \$999⁹⁹ PR ★

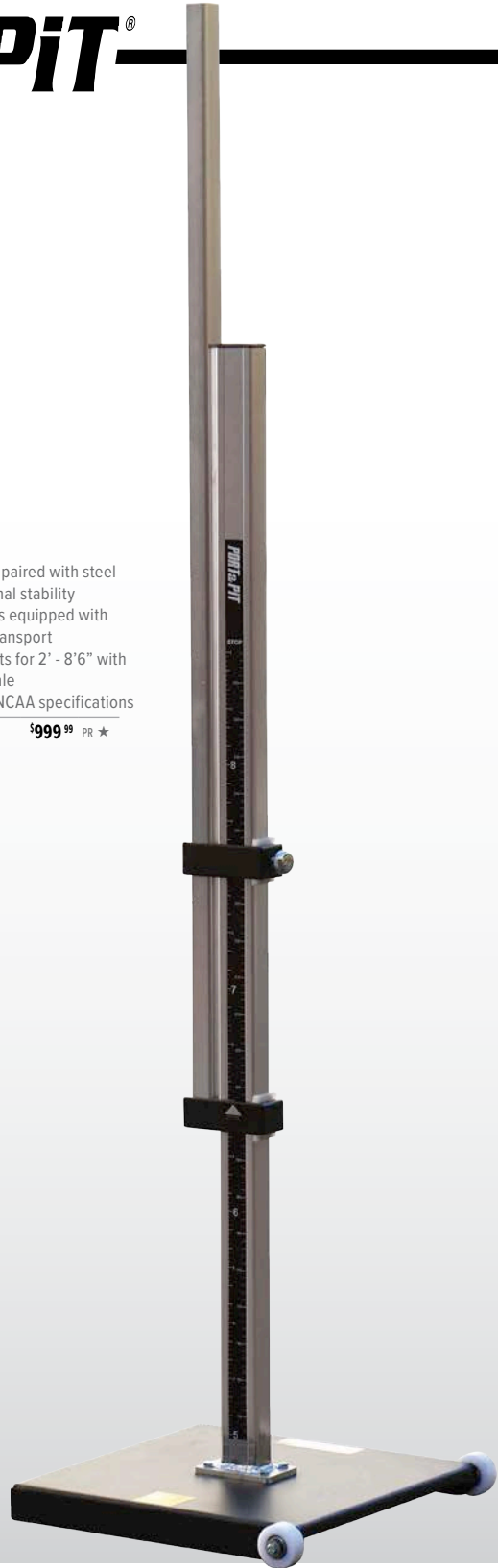

PREMIER HJ CROSSBAR

- Pole is 13' 1 1/2"
- Meets collegiate, international, and NFHS specification
- 2 Year Limited Warranty

AFHJ1500 \$89⁹⁹ EA ★ 
AFHJ1503 Set of 3 \$229⁹⁹ SET ★ 

S&H= \$75⁰⁰ PER ORDER (Up to 3 Crossbars)

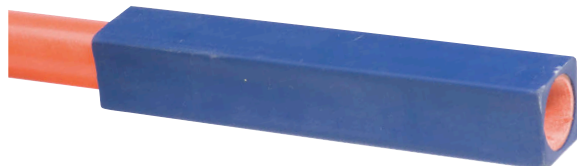

HURDLES



ELITE HIGH SCHOOL

- The standard for elite high school track programs
- All aluminum square tube construction with welded cross support
- Meets official high school pullover requirements at 30", 33", 36", 39" and 42"
- Meets high school specifications
- Ships assembled

GA402

Specify Color

\$499⁹⁹ EA



HIGH SCHOOL

- Powder coated steel U-shaped single cross support design
- Weighted base and Lexan gateboard
- 41" hurdle adjustable to 30", 33", 36", 39" and 42"
- Meets high school specifications

GA403

Specify Color

\$349⁹⁹ EA

PORTaPiT[™] TRAINING HURDLE

- Galvanized Steel lower and Anodized Aluminum upper
- Upper and Lower Nylon Gates breakaway with ease
- Four height adjustments 30", 33", 36", 39"
- 40"W x 19"D x 76"H 23 lbs
- Available November 2018

1453174

\$279⁹⁹ EA ★



FLIGHT HURDLE CART

- Sturdy steel construction with black powder coated finish
- Four wheel design provides superior moveability
- Designed for "L" shaped hurdles only
- Holds 8-10 hurdles

GA4630

\$699⁹⁹ EA ★



HURDLE TRANSPORT CART

- Steel construction with durable black powder coated finish
- Large swivel casters for easy transportation
- Compatible with both rocker and "L" shaped hurdles
- Holds 15-20 hurdles

GA4020

\$1,599⁹⁹ EA ★

1459232 Hurdle Cart Cover, please specify Graphics

\$449⁹⁹ EA





FOAM TRAINING HURDLE

- Lightweight foam training hurdle with carrying handle
- Tough vinyl shell allows for indoor and outdoor use
- Adjustable to 30" 33" 36" and 39" heights

90 Day Limited Warranty

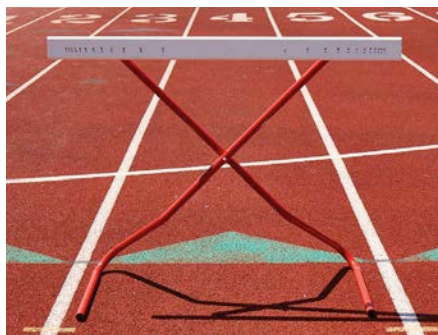
1454088 \$249⁹⁹ EA ★



PORTaPiT[™] X-TRAINER

- Ideal hurdle for plyometrics, speed, and agility.
- Adjusts from 6" to 42"
- Inexpensive style for beginners to use
- Hurdle folds flat for easy transport and storage

1274509

\$89⁹⁹ EA ★

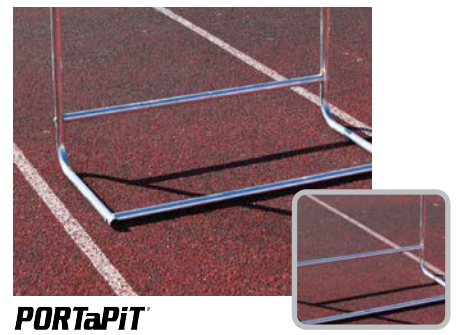

PORTaPiT[™] JUNIOR TRAINING

- Lightweight all anodized aluminum construction
- Includes PVC hurdle board and nylon breakaway gate with hook-and-loop grip
- Rocker design will automatically right itself
- Instant locking at 5 heights: 22", 24", 26", 28" and 30"
- Weight: 10 lbs.

AJEVXXXX
AVELCROS

Nylon Breakaway Gates

\$109⁹⁹ EA ★

\$8⁹⁹ EA ★



ADVANTAGE

- Meets NFHS and NCAA specifications
- Strong high quality mill finish aluminum
- Concealed EZ glide weights to meet official pullover standards

GAAADVA Specify Riser Color \$349⁹⁹ EA ★



ELITE

- Meets NFHS, NCAA and IAAF specifications
- Strong high quality mill finish aluminum
- EZ glide weight presets lock in for precise pullover

GAAFRLH Specify Riser Color \$389⁹⁹ EA ★



STANDARD HURDLE BOARD PRINTING

Standard printing on boards, 1-color with block lettering

GA946 59 Hurdles or Less/per order \$60⁰⁰ PER ORDER

CUSTOM HURDLE BOARD PRINTING

Custom printing on boards, up to 4-colors with logo

GA946 59 Hurdles or Less/per order \$110⁰⁰ PER ORDER

FREE OFFER!!

Buy 60 hurdles or more and we will place custom lettering on the hurdle board at no charge. Put your mascot or event title on your hurdles! No set-up fee. Please supply your artwork.



COMPETITION ROCKER

- Meets NFHS specifications
- Lightweight, high quality anodized aluminum alloy
- Impact absorbing PVC gateboard

GAAHSRX Specify Riser Color \$279⁹⁹ EA ★



HIGH SCHOOL ALUMINUM

- Meets NFHS specifications
- Lightweight, high quality anodized aluminum alloy
- Impact absorbing PVC gateboard

GAAFURY Specify Riser Color \$209⁹⁹ EA ★





PYRAMID SPIKES

BAG OF 100

- AASPKP18**
- AASPKP14**
- 1098273**



- 1/8" \$21.99 PACK OF 100
- 1/4" \$21.99 PACK OF 100
- 3/16" \$21.99 PACK OF 100

NEEDLE SPIKES

BAG OF 100

- AASPKN14**
- 1098280**



- 1/4" \$21.99 PACK OF 100
- 3/16" \$21.99 PACK OF 100

T-HANDLE SPIKE WRENCH

- For easily removing and tightening your spikes

GA846

\$21.99 EA



RELAY BATONS

- Lightweight anodized aluminum baton
 - Features smooth rolled-in edges and non-slip ground finish
 - Official size
- Color Options: Green, Red, Blue, Gold, Silver, Black, Purple.

- AALBAT**
- APLBATONPK**

- Aluminum Baton \$7.99 EA ★
- Yellow (plastic) - Pack of 6 \$14.99 PACK OF 6 ★



PORTaPIT[®] INDOOR STARTING BLOCKS

- Non-slip, poly-blocks make it easy to practice indoors during inclement weather
- Simply apply pressure to blocks with foot and blocks provide the athlete with non-slip starts indoors

6036XXXX

\$79.99 PR ★

SPIKE KIT

Includes a variety of spikes plus a T-handle spike wrench. Extra dividers are included in each spike kit to maximize your storage options of up to 13 compartments
Storage Case: 14.5" x 9.75" x 2.25"

- 3 bags of 1/8" Pyramid
- 2 bags of 3/16" Pyramid
- 2 bags of 3/16" Needle
- 2 bags of 3/8" Pyramid
- 2 bags of 1/4" Needle
- 1 Gill Storage Case

GA850

\$299.99 EA



STARTING BLOCK CART

- All steel construction with quality blue enamel finish and easy rolling
- Holds 10 blocks and has storage for spikes and accessories.
- 10" x 2 3/4" wheels

20010511

\$549.99 EA ★



PORTaPIT®

STARTING BLOCKS



COMPETITION

- All steel components
- Spring loaded plunger for pedal adjustment and secure locking
- Complete with spikes for all surface types

ASB2000S

\$169⁹⁹ EA ★

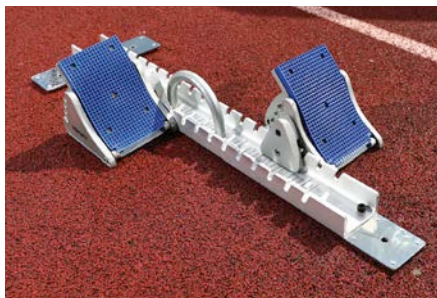

PREMIER

- Cast aluminum, 4-angle wide adjustable pedals
- Durable polished aluminum chrome rail
- Block measures: 12.5"W x 33"L
- Complete with spikes for all surface types

ASB4500X

\$279⁹⁹ EA ★

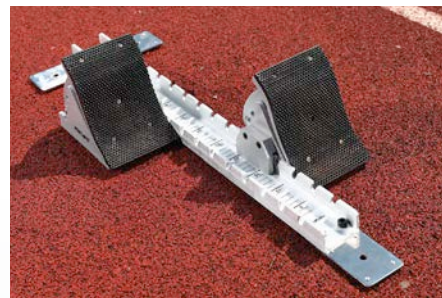

ELITE

- Cast aluminum, 4-angle wide adjustable pedals
- Durable aluminum rail
- Block measures: 12"W x 35"L
- Complete with spikes for all surface types

ASB3500X

\$219⁹⁹ EA ★

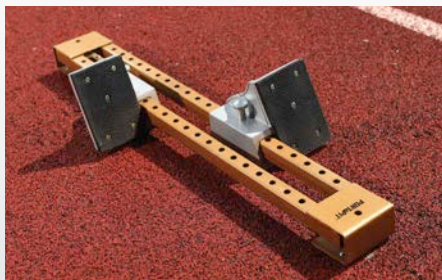

SCHOLASTIC

- Steel double rail with cast pedals and plunger adjustment
- Great for middle and high school programs
- Complete with spikes for all surface types

ASB1500X

\$159⁹⁹ EA ★

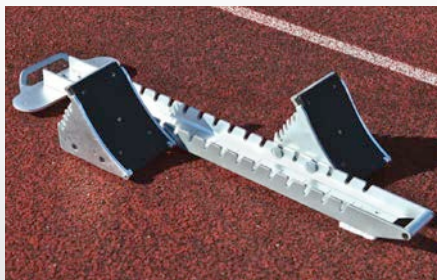

ULTIMATE

- All aluminum construction
- 5-angle adjustable pedals
- IAAF certified and comes with 15mm spikes
- Easy to grab handle

ASB5000X

\$299⁹⁹ EA ★

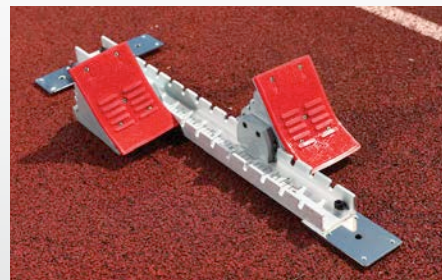

ELITE II

- Cast aluminum, 4-angle adjustable pedals
- Durable aluminum rail
- Block measures: 11"W x 30"L
- Complete with spikes for all surface types

ASB3000

\$199⁹⁹ EA ★

GILL
ATHLETICS



FUSION 4

- Standard 4" x 8" pedals
- Meets NFHS, NCAA and IAAF specifications, IAAF certified
- Color Options: Black, Dark Green, Orange, Red, Royal Blue.

GA730181C

Specify Pedal Color

\$729⁹⁹ EA

FUSION 10

- Exclusive 8" x 10" pedal allows full heel support for the best starts
- Precise and consistent foot placement is ensured using intergrated pedal markings
- Angled spikes in base of pedals guarantee no slipping during explosive starts
- Built in handle allows for easy carriage between locations
- Pedals adjust to 30°, 40°, 50°, 60°
- Meets NFHS, NCAA and IAAF specifications, IAAF certified
- Color Options: Black, Dark Green, Orange, Red, Royal Blue.

GA730183C

Specify Pedal Color

\$899⁹⁹ EA

FUSION 8

- Exclusive 8" x 8" pedals designed for a more aggressive acceleration pattern
- Meets NFHS, NCAA and IAAF specifications, IAAF certified
- Color Options: Black, Dark Green, Orange, Red, Royal Blue.

GA730182C

Specify Pedal Color

\$829⁹⁹ EA

AVAILABLE COLORS

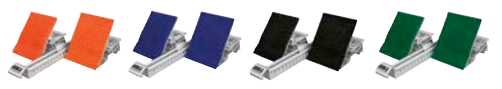



VIBE

- Mid-Spin discus
- ABS plastic side plates
- High quality steel rim
- Meets NFHS, NCAA and World Athletics specifications



GAVIBE10	75% Rim Weight-1K	\$199 ⁹⁹ EA
GAVIBE16	75% Rim Weight-1.6K	\$219 ⁹⁹ EA



S SERIES

- Low-Mid spin with exclusive, high impact translucent side plates
- High quality steel rim
- Meets NFHS, NCAA and World Athletics specifications



GA75810	58% Rim Weight-1K Pink	\$99 ⁹⁹ EA
GA76116	61% Rim Weight-1.6K Electric Green	\$119 ⁹⁹ EA
GA76720	67% Rim Weight-2K Electric Green	\$139 ⁹⁹ EA



HOLLOWOOD STAR

- Recommended for all levels
- Straight grained hard rock maple side plates
- High quality steel rim, up to 75% rim weight
- Meets High School, NCAA, and IAAF specifications



GA300	2K	\$499 ⁹⁹ EA
GA305	1.6K	\$479 ⁹⁹ EA
GA313	1K	\$449 ⁹⁹ EA



S SERIES

- High quality steel rim
- Colorful, high impact translucent plates
- Meets NFHS, NCAA and World Athletics specifications



GA77510	75% Rim Weight-1K Aqua	\$119 ⁹⁹ EA
GA77516	75% Rim Weight-1.6K Cobalt Blue	\$139 ⁹⁹ EA
GA77520	75% Rim Weight-2K Cobalt Blue	\$164 ⁹⁹ EA



S SERIES

- High quality steel rim
- Colorful, high-impact translucent side plates
- Meets NFHS, NCAA and World Athletics specifications



GA77810	78% Rim Weight-1K Galaxy Purple	\$134 ⁹⁹ EA
GA78016	80% Rim Weight-1.6K Volcano Red	\$149 ⁹⁹ EA
GA78020	80% Rim Weight-2K Volcano Red	\$199 ⁹⁹ EA



G SERIES

- High-moment G-Series offers throwers precision crafted discus
- High-spin steel alloy rim
- Meets NFHS, NCAA and World Athletics specifications
- World Athletics certified



GA88110	83% Rim Weight-1K Zircon Red	\$239 ⁹⁹ EA
GA88316	83% Rim Weight-1.6K Zircon Red	\$279 ⁹⁹ EA
GA88320	83% Rim Weight-2K Zircon Red	\$319 ⁹⁹ EA

PORTaPiT[®] WOOD

- Economy wood discus with steel rim
- Ideal for competition as well as practice
- 60-70% rim weight
- Meets NFHS specifications



1101409	2K	\$69 ⁹⁹ EA ★
1101416	1.6K	\$64 ⁹⁹ EA ★
1101423	1K	\$49 ⁹⁹ EA ★

PORTaPiT[®] BLACK RUBBER - OFFICIAL

- Molded to the official weight and specs
- Recommended for practice and official competition
- Meets NFHS specifications



1101430	2K	\$26 ⁹⁹ EA ★
1101447	1.6K	\$21 ⁹⁹ EA ★
1101454	1K	\$19 ⁹⁹ EA ★

PORTaPiT[®] BLACK RUBBER - PRACTICE

- Affordable hard rubber discus
- Excellent for training at the high school or middle school level.



ARD1.6XX	1.6K	\$13 ⁹⁹ EA ★
ARD1.OXX	1K	\$12 ⁹⁹ EA ★

PORTaPiT[®] GOLD LO-SPIN DISCUS

- High-impact ABS plastic side plates with a steel rim
- High retention discus makes disc stay in hand longer for more power
- 75% rim weight



ADLSHS6D	1.6K	\$89 ⁹⁹ EA ★
ADLS1K6D	1K	\$84 ⁹⁹ EA ★

PORTaPiT[®] CHALLENGER DISCUS

- Plastic plated discus
- Priced for general purposes practice or dual meet competition
- 73% rim weight
- Meets NFHS specifications



1101386	1.6K	\$69 ⁹⁹ EA ★
1101393	1K	\$64 ⁹⁹ EA ★

PORTaPIT®



BRASS

- Lathe turned to minimum diameter allowed in competition
- Machine finished for excellent grip and calibrated to exact weight
- Unsurpassed quality
- Meets all Collegiate, International & High School Federation specifications

ABSHOT12 115mm 12lbs \$179⁹⁹ EA ★

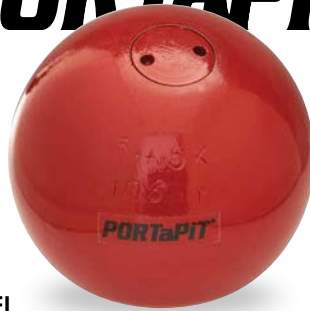

STEEL

- Solid steel shot for the advanced thrower
- Machine turned to different diameters
- Lathe turned and balanced for an overall best performance
- Polyurethane paint coated for smooth and durable finish
- Meets NFHS specifications

1101508 103mm 12 lbs \$129⁹⁹ EA ★



TURNED IRON

- Solid cast iron shot
- Machine turned to different diameters
- Balanced for high performance throws
- Meets NFHS specifications

AFSHOT16 16 lbs-Blue \$129⁹⁹ EA ★
AFSHOT12 12 lbs-Silver \$99⁹⁹ EA ★
AFSHOT4K 4K-Red \$89⁹⁹ EA ★

BSN SPORTS

GYM CHALK

- For weight-lifting or gymnastics
- Conveniently wrapped in 2 oz. blocks
- Eight blocks per 1 lb. package

PGE4360X \$29⁹⁹ LB ★



SCHOLASTIC

- Cast iron weight shot
- Great for high school/middle school practice
- Priced to fit your budget

ARSHOT12 12 lbs \$59⁹⁹ EA ★
ARSHOT4K 4K \$54⁹⁹ EA ★
1101591 8 lbs \$49⁹⁹ EA ★
1101614 6 lbs \$44⁹⁹ EA ★



INDOOR

- High visibility red indoor shot has that outdoor shot feel
- Soft enough not to mark or damage the gym or indoor facility floor
- Designed for training purposes only, not certified for competition.

6048XXXX 4K \$84⁹⁹ EA ★
6082XXXX 12lb 5.44K \$99⁹⁹ EA ★

Need help selecting the correct size equipment for your athlete? Use the chart below to make sure your athlete is using the correct size for their level of competition.

Still have questions? Please call us at (877) 246-6897

Gender	Age	Hammer	Shot Put	Discus	Javelin
Girls	<10		6#		*
Girls	11-12		6#	1.0K	*
Girls	13-14		6#	1.0K	600gr
HS Girls	15-16	4K	4K	1.0K	600gr
HS Girls	17-18	4K	4K	1.0K	600gr
Collegiate Women		4K	4K	1.0K	600gr

Gender	Age	Hammer	Shot Put	Discus	Javelin
Boys	<10		6#		*
Boys	11-12		6#	1.0K	*
Boys	13-14		4K	1.0K	600g
HS Boys	15-16	12#	12#	1.6K	800g
HS Boys	17-18	12#	12#	1.6K	800g
Collegiate Men		16#	16#	2.0K	800g

PORTaPIT®

IMPLEMENT CART

- Constructed of 1" square heavy wall steel tube finished with Gray Hammertone Powder Coated finish
- Holds 12 discus, 7 Javelin, 15 Shots, can also be used for Hammers
- Transports load easily on 10" solid rubber wheels and 4" swivel Casters
- 40"L x 24"W x 37"H 64 lbs
- Available November 2018

1453173 \$579⁹⁹ EA ★



SHOT AND DISCUS CARRIER

- Water resistant polyester carrier holds two discus, two shots or one of each
- Comes with shoulder strap for easy transport

ASDCXXXX \$24⁹⁹ EA ★

DISCUS/SHOTS CIRCLES



STEEL DISCUS CIRCLE

- Three sections of 1/4" x 1 1/2" flat powder coated steel
- Designed to be mounted on top of concrete surface
- Anchor bolts included
- Meets NFHS specifications

GA371

\$999⁹⁹ EA



ALUMINUM CIRCLES

- Four sections of 1" x 3/4" extruded aluminum angle
- Designed to be cast into concrete
- Discus circle can also be mounted to surface
- Compatible with toeboards GA358, GA363
- Meets NFHS, NCAA and IAAF specifications

GA369 Shot/Hammer
GA370 Discus

\$459⁹⁹ EA
\$479⁹⁹ EA



STEEL SHOT CIRCLE

- Four sections of 1/4" x 1 1/2" flat powder coated steel
- Designed to be mounted on top of concrete surface
- Anchor bolts included
- Compatible with toeboards GA359, GA364
- Meets NFHS specifications

GA373

\$649⁹⁹ EA



TOE BOARDS



SYNTHETIC SHOT TOEBOARD

- Molded low density polyethylene designed for 3/4" depressed surface
- Compatible with circles GA369
- Meets NFHS, NCAA and IAAF specifications

GA358
GA359

For Depressed Pad
For Level Pad

\$599⁹⁹ EA
\$599⁹⁹ EA



ALUMINUM SHOT TOEBOARD

- Cast aluminum designed for a 3/4" depressed surface
- Compatible with circles GA369
- Meets NFHS, NCAA and IAAF specifications

GA363
GA364

For Depressed Pad
For Level Pad

\$949⁹⁹ EA
\$949⁹⁹ EA





PRO DOWN DISCUS CAGES

- Consists of six galvanized 2 3/8"OD, 12 gauge steel upright poles
- Five galvanized steel top rungs helps eliminate neg sag
- The knotless weather treated nylon net has a breaking strength of 180 lbs.
- Comes with ground sleeves, Net Height: 10' 6"

GA80401	Cage with Ground Sleeves	\$3,299⁹⁹ EA	
GA80402	Cage with Plates	\$4,999⁹⁹ EA	
GAM2003	Replacement Net	\$2,249⁹⁹ EA	



HIGH SCHOOL PORTABLE DISCUS CAGE

- Designed for set up or removal as needed
- Poles: (6) 6063-T6 aluminum net poles
- Net is #504 knotless nylon with 180 lb breaking strength
- Net height: 13' 6"
- Bases: A500 Grade B steel with wheels for transportability and weighted with 5 gallon jugs to be filled with sand or water

GA732220	Cage	\$14,999⁹⁹ EA	
GAM2055	Cage Net	\$1,499⁹⁹ EA	



SHOT CAGE

- Poles: (4) 6063-T6 aluminum or A513 steel
- Net is weather treated nylon 6 net with 180 lb breaking strength
- Net height: 13' 6"
- 18" hinged net arms secure net at front two poles with ground stakes used at back poles
- 20" deep ground sleeves

GA8050	Aluminum Cage	\$4,999⁹⁹ EA	
GA805	Steel Cage	\$4,299⁹⁹ EA	
GAM2054	Cage Net	\$1,299⁹⁹ EA	



COMPETITION 13' 6" DISCUS CAGE

- All aluminum high school discus cage with 6 permanent in-ground sleeves and 4" square posts.
- Comes complete with sleeve caps.
- Meets High School specification.
- Special pulley system allows easy daily removal of netting.
- 30" cantilever post for Offset netting provides for maximum protection.
- Net is 1-3/4" weather treated nylon with weighted bottom.
- Includes spectator warning signs.

4 Year Limited Warranty

AHSDCAGE		\$4,749⁹⁹ EA ★	
SNHSDNET	Replacement Net-13'H x 54'L	\$699⁹⁹ EA ★	



HIGH SCHOOL DISCUS CAGE

- Aluminum poles: 2 7/8" outside diameter with rolled offset for safety
- Steel poles: 2 1/2" square A513 with rolled offset for safety
- Net: 180 lb breaking strength
- Net height: 13' 6"
- Meets NFHS specifications

GA8010	6-Pole Cage-Aluminum	\$5,499⁹⁹ EA	
GA8030	6-Pole Cage-Steel	\$4,999⁹⁹ EA	
GAM2055	Cage Net	\$1,499⁹⁹ EA	
GA80102	Barrier Netting for Alum Cage	\$849⁹⁹ EA	
GA80302	Barrier Netting for Steel Cage	\$799⁹⁹ EA	

VAULT BOXES



ALUMINUM VAULT BOX

- Welded aluminum construction
- Meets High School and NCAA specifications
- IAAF certified

GA502 \$999⁹⁹ EA



SLIDING VAULT BOX

- Sliding vault box allows vaulters to perfect the run, plant, and take-off
- Pole carriage, run mechanics, tempo, and step placement are more effectively learned using this training tool
- Constructed of high impact thermoplastic, same size as regular vault box
- To be used as a training aid, not to be used as vault box in meets

GA2531 \$949⁹⁹ EA

MEASURING WHEELS

FIBERGLASS MEASURING TAPES

- Durable, long-lasting, vinyl-coated fiberglass tapes in ABS shatter resistant case
- Closed reel tapes feature an easy to wind, flush-folding handle
- Open reel tapes feature easy to wind return, handle and shoulder strap
- Printed with inches/feet on one side and centimeters/meters on the other
- Includes end-loop for one-person measuring



1. MSTAP50X	50'-15M	\$27 ⁹⁹ EA ★
2. MSTAP100	100'-30M	\$33 ⁹⁹ EA ★
3. MSTAP165	165'-50M	\$41 ⁹⁹ EA ★
4. MSTAP200	200'-60M	\$53 ⁹⁹ EA ★
5. MSTAP330	330'-100M	\$82 ⁹⁹ EA ★

ELECTRONIC MEASURING WHEEL

- This electronic wheel has a steel frame to make the sturdiest electronic wheel
- Easy-to-read digital counter is in the most protected spot of wheel
- Designed to NEMA Class II standards, not be damaged by the rain
- Display backlit 7-digit display for low-light usage, up to 99,999 ft or tenths and metric, Counter requires 2AA batteries(not included)

GA9701 \$479⁹⁹ EA



TAKE OFF BOARDS



ARCHED JUMP BOX

- A convex jumping box made of lightweight steel
- Covered in synthetic track material so your athletes have the same feeling as the runway or high jump apron
- 8" high in the middle by 30" wide by 47" long

GATA193 \$1,099⁹⁹ EA

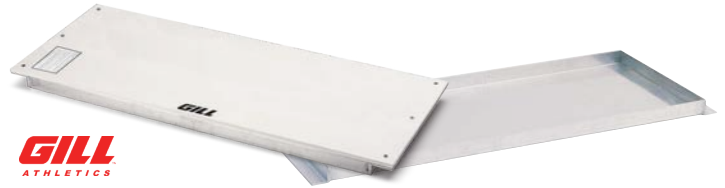

HIGH SCHOOL TAKE-OFF BOARD

- Complete system: Installation tray, aluminum base board, and reversible take-off board
- Made of synthetic material for longer lifespan
- Meet NFHS specifications

GA441TS Complete HS System \$1,049⁹⁹ EA
GA44105 Replacement 19.5" Take Off Board \$329⁹⁹ EA



100 FT. PENNANT STREAMER

- Rope streamers with 18" nylon cloth pennants in a variety of colors: Blue, Green, Red, White and Yellow
- Use to dress up your field, crowd control or for cross-country events
- Sold in lengths of 100' (approx. 48 flags per 100')

1260XXXX Streamers \$29⁹⁹ EA ★

ECONOMY MEASURING WHEEL

- Lightweight and extremely durable
- Measures in English up to 10,000 feet
- Handle folds down for easy storage

1378131 \$229⁹⁹ EA ★





TIMERS AND JUDGES STAND

- Holds 10 people seated or 20 people standing
- Five rows of 48" long steps
- Rail support along the back for safety
- Red enamel finish, with galvanized seats, footrests, and backrest
- Easy mobility provided by 8" diameter wheels on back

GA995 \$1,799⁹⁹ EA



ROLLOUT RUNWAY

- Our 10mm rollout runway installs in seconds with no bonding necessary.
- Solve your runway problems and protect your track
- Available in 48" width.
- Roll up after use for easy transportation and storage.

AFRUM10M \$6⁹⁹ SQ.FT



LANDING ZONE[®] PIT COVERS

- Landing Zone ballasted pit protectors keeps sand in...even in high winds, but keeps cats and kids out.
- Steel chain edge hem all around keeps protector down in high winds.
- All units are made to the specific size ordered.
- Pit will **not** stay dry in the event of rain!
- Add 2' to each dimension so the protector extends over the pit and onto the track.
- Colors: Black, Dk Green, Maroon, Navy, Red, Royal, Orange, White, Yellow

1298017 Vipol[®] Matrix Material \$6⁹⁹ SQ.FT
 1298024 Vinyl Polyester Material \$6⁹⁹ SQ.FT

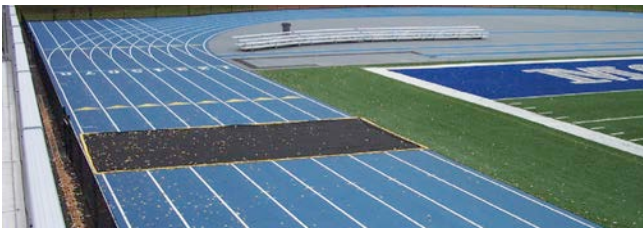

CROSS-OVER ZONE[®] TRACK PROTECTOR

- Made with a tough, durable polypropylene non-woven fabric
- Entire edge is vinyl wrapped with internal steel chain weighting, making it wind-proof (No stakes required)
- Easy-to-install temporary cover, resists and cushions against steel-tipped football cleats, yet allows rain to drain through
- Saves modern track materials from damaging cleats and other traffic
- Color: Black with Gold or White edging

1248326	7.5'W x 30'L	\$899 ⁹⁹ EA	
1248333	7.5'W x 40'L	\$1,099 ⁹⁹ EA	
1248340	7.5'W x 50'L	\$1,149 ⁹⁹ EA	
1248296	15'W x 30'L	\$1,199 ⁹⁹ EA	
1248302	15'W x 40'L	\$1,399 ⁹⁹ EA	
1248319	15'W x 50'L	\$1,699 ⁹⁹ EA	
1248357	Custom Size - 420 sqft Minimum Per Piece	\$3 ⁹⁹ SQ.FT	



ALUMINUM MAINTENANCE RAKE

- All aluminum construction
- Durable and lightweight with oversized teeth for easy field grooming & pit maintenance
- Use one side to rake and the other side to level
- 58" long handle

1196238	Size - 24"W	\$119 ⁹⁹ EA ★
1196245	Size - 36"W	\$129 ⁹⁹ EA ★
1196252	Size - 48"W	\$139 ⁹⁹ EA ★



THREE PLACE AWARD STAND W/ GRAPHICS

- Three Place Award Stand for 1st, 2nd, 3rd Place
- Made of 18 oz coated vinyl, high density foam
- 72"L x 24"W x 23"H
- Please allow 3-4 weeks for delivery

1459231 Please specify graphics \$1,144⁹⁹ EA ★

4 DIGIT PERFORMANCE INDICATOR

- Aluminum construction with steel roll away base
- 9" tall numerals
- Rotates 360 degrees
- Powder coated in a gloss black

GA79100 \$1,499⁹⁹ EA



2 DIGIT LAP COUNTER W/ BELL

- Aluminum construction with steel roll away base, with bell
- 9" tall numerals
- Rotates 360 degrees
- Powder coated in a gloss black

GA79300 \$1,049⁹⁹ EA





ECONOMY STOPWATCH

- Single event watch
- 1/100 second precision with lap counter (1st 30 minutes)
- Beep, beep alarm with chime and snooze
- 12/24 hour display option
- Count up to 23 hrs, 59 min., 59 sec.
- Detachable lanyard

1266702	Black	\$12 ⁹⁹ EA ★
1266696	6 Color Pack	\$74 ⁹⁹ PACK OF 6 ★



106L STOPWATCH

- Single events and time outs
- Cumulative splits, 1-2 Fast Finish
- 1/100 second with lap
- Daily alarm and hourly chime

1269062	Black	\$15 ⁹⁹ EA ★
1269079	8 Color Pack	\$99 ⁹⁹ PACK OF 8 ★



K-150 STOPWATCH

- 1/100 second precision with lap counter (for the first 30 minutes)
- Calendar and Time display(12/24 hr format)
- Daily alarm
- Hourly chime

5 Year Limited Warranty

1376384	\$35 ⁹⁹ EA ★
----------------	-------------------------



AX725 STOPWATCH

- 16 Dual split memory
- Dual split (lap & cum)
- 1 Button rapid split and reset
- 10 hour range
- Water resistant
- 5-year battery life

5 Year Limited Warranty

MSSTP725	\$32 ⁹⁹ EA
-----------------	-----------------------

601X STOPWATCH

- Times single event and cumulative splits
- Large digits for easy viewing
- 1-2 fast finish, 30 minute range
- 5 year "no proof" warranty
- 5-year battery life

12440191	\$24 ⁹⁹ EA
-----------------	-----------------------



NEW!

HALO STARTING DEVICE

- 12 total LED lights that wrap around both sides of the device so that the starters can see the flash clearly from afar
- Sounds both a tone and bang sound
- Connects wirelessly to the Gill Wireless Starter System
- Features an audio jack for compatibility with existing speaker systems
- Compatible with FinishLynx and other FAT systems
- Powered by one 9V battery
- Includes: Halo Device, Protective Carrying Case, Audio cable, Timing System cable, 9V battery, Phillips head screwdriver
- Complete Wireless System includes: Halo Device, 50 watt speaker(+90dB) plus durable tripod

GAE49710	Starting Device Only	\$349 ⁹⁹ EA
GAE49720	Complete Wireless Starting System	\$1,799 ⁹⁹ EA

Robic



Robic SC-500E STOPWATCH

- One-step timing for all events
- Start/stop/reset operation
- Water resistant to 30 meters
- Audible beep confirmation or silent operation

1378161

\$26⁹⁹ EA



Robic SC-505W STOPWATCH

- 12 Memory Chrono
- Time events up to 24 hours in 1/100 second resolution
- 12 Memory recall
- Automatic lap count to 199

MSSTP505

Black \$34⁹⁹ EA

1240283

6 Color Pack \$199⁹⁹ SET

1451079

Red \$39⁹⁹ EA

1451080

Yellow \$39⁹⁹ EA

1451081

Blue \$39⁹⁹ EA

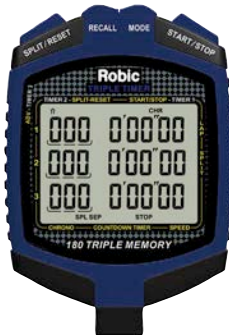

Robic SC-899 SPEED AND SPORT TIMER

- 180 Dual memory recall capacity and a total reading capacity of 1000 times
- Use the memory without interrupting timing
- Water resistant design, time of day, alarm, and calendar

1452988

\$69⁹⁹ EA



1000W DUAL STOP WATCH W/COUNT DOWN TIMER

- Single Event-Lap or Split Timing to 10 hours
- 1/100 second precision Countdown Timer
- Track 2 activities Using the stopwatch and Countdown simultaneously
- Water Resistant—Soft Rubber grips offer Comfort
- Prism pack includes one each Blue, Green, Orange, Purple, Red and Yellow

1399652

Black Only \$29⁹⁹ EA

1399651

6 Color Pack \$159⁹⁹ PACK

ULTRAK

499 STOPWATCH & PRINTER

- Stopwatch system with a portable printer
- 500 lap dual memory that stores lap and cumulative times
- Events are kept in memory segmented by date and run number; all data can be printed out or printed after event
- Dual countdown timer and automatic split release

5 Year Limited Warranty

MSSTP499SP



\$419⁹⁹ EA

MSSTPP25

EXTRA PRINTER PAPER ROLLS-Box of 25

\$62⁹⁹ BOX OF 25

360 STOPWATCH

- 30 dual splits recallable memory
- Lap/cumulative splits
- Recalls times forwards/backwards
- Measures to 10 hours, time and calendar, alarm, lithium battery

3 Year Limited Warranty

1151824

\$36⁹⁹ EA



340 STOPWATCH

- Display of cumulative splits
- Large numerical display
- Time, calendar, alarm
- Water resistant; lithium battery

3 Year Limited Warranty

1151830

\$22⁹⁹ EA



L10 8-LANE TIMER

Road Race (Cross Country) Mode

- 8,000 memory for individual finishers in single or multiple events
- Four digit bib numbers, four digit place counter
- Bib number entry at finish or add/edit after event
- Automatic print out during event
- Single and multiple start times, up to 99 waves in multiple start race

Track Race Mode

- 8 lap/split lane buttons
- Linkgate allows single wire to lane timer
- 8,000 dual split memory for single or multiple events
- Four digit bib numbers

Automatic printout of date, run number and record type

1151794

\$949⁹⁹ EA



495 STOPWATCH

- 100 dual split recallable memory
- Takes splits from within recall mode
- Time, calendar and alarm
- Water resistant; lithium battery

5 Year Limited Warranty

1188271

\$62⁹⁹ EA



S149 STOPWATCH/PRINTER SYSTEM

- Measurable up to 10 hours in 1/100 of a second
- Store and recall of up to 300 split/lap times
- Memory segregated by event
- Multiple event memory
- Memory recall during operation

1380581

\$599⁹⁹ EA





NFHS APPROVED

SPALDING

TF-VB5

- Select Japanese leather cover
- 2-ply soft cloth lining inside
- Floating butyl bladder
- Indoor use only

WCVB5 Specify Color \$78⁹⁹ EA
WC721258 White \$78⁹⁹ EA

ADDITIONAL COLOR OPTIONS



NFHS APPROVED

SPALDING

TF-VB3

- Tournament microfiber composite leather cover
- Floating butyl bladder
- V-Seam construction

WCVB3 Specify Color \$55⁹⁹ EA

ADDITIONAL COLOR OPTIONS



molten
FLISTATEC

- FLISTATEC Flight Stability Technology
- Premium microfiber composite cover
- Indoor use only

Color Options: FIVB, NCAA, USAV.

1462208 Specify Color \$89⁹⁹ EA



molten
SUPER TOUCH

- Premium Japanese leather cover
- Uni-bladder cotton wrapped construction
- NFHS approved

1461864 Specify Color \$84⁹⁹ EA



molten
SUPER TOUCH-NCAA

- Premium Japanese leather cover
- Uni-bladder cotton wrapped construction
- Official volleyball of the NCAA® Women's Championships

1273656 \$84⁹⁹ EA



molten
L2 COMPOSITE

- Microfiber composite
- Uni-bladder cotton wrapped construction
- Indoor use only

1455044 Specify Color \$57⁹⁹ EA

NFHS APPROVED

ADDITIONAL COLOR OPTIONS



TACHIKARA
SV-5WM LEATHER

- Perfect value for practice in team white or team colors
- Full Grain Leather cover
- Indoor use only

1371299 Specify Color \$59⁹⁹ EA



ALL AMERICAN

- Premium composite leather
- Approved by AVCA
- Indoor use only

1460103 Specify Color \$69⁹⁹ EA



LEXUM

- Soft microfiber cover
- Ideal tack to create maximum control
- Indoor use only

1460693 Specify Color \$59⁹⁹ EA



PERFECTION®

- Top-Grade leather cover
- Total Feel Technology™
- Indoor use only

1460094 Specify Color \$84⁹⁹ EA



SV-5W GOLD LEATHER

- U.S. Premium leather cover
- Patented Dual Bladder Construction (DBC™) for a more responsive and controlled touch
- Impact reducing air layer buffers and evenly disperses force of digs, passes and spikes
- Indoor use only

TACSV5WX White \$84⁹⁹ EA
1050912 Red/White/Blue \$84⁹⁹ EA



SV-5WS "SENSI-TEC"™ COMPOSITE

- Sensi-Tec™ micro-fiber composite leather cover
- Patented Loose Bladder Construction (LBC™)
- Hand finished panels and seams
- Indoor use only

TACSV5WS White \$52⁹⁹ EA



SV-5WSC "SENSI-TEC"™ COMPOSITE

- All colors are NFHS approved
- Indoor use only

1072266 Specify Color \$59⁹⁹ EA



K1 SILVER

- Internal command lining enables players to evoke more power and velocity
- Durable composite leather cover made to last
- Soft feel for intense training sessions
- Indoor use only

WLWTH1895B Specify Color \$59⁹⁹ EA



K1 GOLD

- Durable leather cover
- Command lining for powerful kills with control
- Responsive feel for perfect touches
- Indoor use only

WLWTH1895A Specify Color \$74⁹⁹ EA



Mikasa
VFC1000

- Cotton core construction
- Premium Japanese leather cover
- True Shape Accu-Balance Technology
- Indoor use only

1460977 Specify Color \$89⁹⁹ EA



Mikasa
VQ2000

- Competition game ball with micro-cell composite cover
- True Shape Accu-Balance Technology
- Indoor use only

1459597 Specify Color \$54⁹⁹ EA



MARK 1
MARK 1 VOLLEYBALL

- Japanese cordley composite leather cover
- Microfiber backing for soft touch feel
- Floating bladder
- Indoor use only

1235593 \$49⁹⁹ EA ★

TOURNAMENT TESTED!



MacGregor
X660 SOFT TOUCH

- Full grain cowhide leather cover
- Competition game ball
- True balance technology
- Indoor use only

2 Year Limited Warranty
MCV660WH \$64⁹⁹ EA ★



MacGregor
X1000 GAME COMPOSITE

- Soft composite leather cover
- Floating bladder construction
- Available in 7 colors
- Indoor/Outdoor use

MCV1000W Specify Color \$47⁹⁹ EA ★



MacGregor
X600 COMPOSITE

- HQ Composite leather cover
- Soft touch technology
- Floating bladder
- Indoor use only

2 Year Limited Warranty
MCV600WH \$52⁹⁹ EA ★



YMCA HERITAGE VOLLEYBALL

- Soft touch high quality composite leather cover
- Official size and weight

1384328 \$39⁹⁹ EA ★



SV-18S COMPOSITE

- Woven-fiber v100 composite
- Single Unit Construction (SUC)
- Indoor use only

1233124 \$42⁹⁹ EA



MacGregor
XL20 COMPOSITE

- Composite leather cover
- Exclusive shape retention bladder
- Indoor use only

2 Year Limited Warranty
MCVL20WH Specify Color \$36⁹⁹ EA ★



SOFT PLAY

- Machine sewn with synthetic leather cover
- Excellent air and shape retention
- Indoor use only

1014167 \$27⁹⁹ EA

TRAINING BALLS

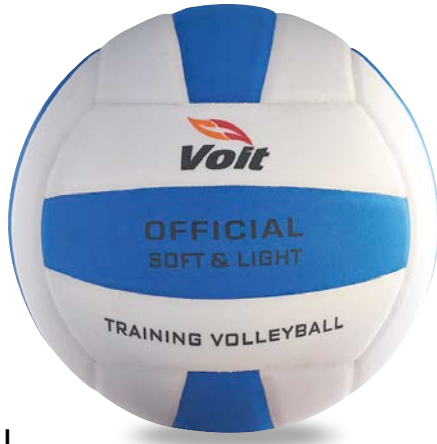

Voit

SOFT TRAINING VOLLEYBALL

- Soft and light training volleyball
- Regulation size but lighter weight for beginners
- Indoor use only

1392604 Royal \$32.99 EA ★



molten®

VB-U12

- Soft microfiber composite cover
- Official size and lightweight
- USYVL approved
- Indoor use only

1462197 Specify Color \$57.99 EA



Voit

LIGHT SPIKE

- Double knit soft polyester fabric cover allows players to practice skills without discomfort
- 30% lighter than official volleyball
- Ideal trainer for developing fundamentals safely

1342536 \$23.99 EA ★



Voit

BUDGET VOLLEY TRAINER®

- Sponge-like vinyl cover
- 18% larger and 12% lighter than an official volleyball
- Economical training ball

VVBUDVT Blue/Yellow \$24.99 EA ★
1297911 Red/Yellow \$24.99 EA ★



TACHIKARA®

TB-18 "THE SETTER"™

- Sensi-tec® micro-fiber composite cover
- Weighted ball builds hand/finger strength
- Weight: 15.7 - 17.5 oz.
- Indoor use only

1091991 \$64.99 EA



Voit

V5 RUBBER COVER

- Molded composition rubber cover
- Nylon wound bladder
- Indoor/Outdoor use

VV5HXXX \$13.99 EA ★



TACHIKARA®

VOLLEY-LITE®

- Sensi-Tec® microfiber composite cover
- Regulation size but lighter weight for younger players
- Helps develop novice players skills faster
- Indoor use only

20011575 White \$49.99 EA
1050905 Scarlet/White/Royal \$49.99 EA
1155549 Additional Colors \$49.99 EA

ADDITIONAL COLOR OPTIONS





Voit

CV4 "SOFT SHOT" STINGLESS

- "Sting-free" Syn-Tec® rubber cover
- Special foam coating makes it durable and soft
- Indoor/Outdoor use
- 2-year Limited Warranty

VCV4HXXX \$24.99 EA ★



MacGregor

X300 RUBBER COVER

- Airtec Open Cell molded rubber cover allows for a thicker rubber without additional weight
- Smoother and softer feel with increased gripability
- Indoor/Outdoor use

1272772 \$19.99 EA ★



Voit

V5RWB RUBBER COVER

- Molded composition rubber cover
- Nylon wound bladder
- Indoor/Outdoor use

1272765 \$19.99 EA ★



Voit

SANDSTORM II

- PU synthetic cover
- Machine sewn panel construction
- Indoor/Outdoor use

1297935 \$29.99 EA ★



Voit

SANDSTORM

- Soft, synthetic leather cover
- Machine sewn panel construction
- Indoor/Outdoor use

1262650 \$24.99 EA ★



molten

BV5000

- Ultimate playability and superior touch
- Hand-stitched soft polyurethane cover
- Official size and weight

1462205 Specify Color \$65.99 EA



molten

V5B5000

- FIVB approved Official beach
- Polyurethane cover machine stitched
- Outdoor use

1455065 \$74.99 EA



Wilson

OPTX

- Enhanced ball tracking
- Superior spin detection
- Official game ball

WLWTH00020XB \$79.99 EA



SCARLET



BLACK

NAVY

• SEE ADDITIONAL BALL CARTS ON PG 260.



HAMMOCK BALL CART

- Tubular galvanized steel frame
- Low profile design makes it easy to turn, reach & spike
- Collapsible unit that stores in carry bag (Included)
- Holds 24 balls
- 48”L x 22”W x 12”D x 40”H - 13 lbs.

1155389 Specify Color \$269⁹⁹ EA



MESH BALL CARRIER

- Comes with shoulder strap, vinyl bottom and mesh top fabric

1235654 22”H x 28”W \$49⁹⁹ EA ★



VOLLEYBALL CARRY BAG

- 9” x 50” black polyester with shoulder strap and strong metal zipper
- Holds 6 volleyballs
- Available in Black only

MSVBAGTB \$49⁹⁹ EA ★



HAMMOCK VB CART

- Galvanized steel construction
- Cart folds up and stores away in a carry bag (included)
- Lightweight and easy to move around the court
- Holds 24 balls

1454525 40”H x 24”W x 24”D \$269⁹⁹ EA ★



E-Z FOLD CART

- Aluminum square frame
- Nylon top with mesh bottom
- Holds 20 basketballs or 30 volleyballs
- Non-marring swivel casters
- Folds to only 6” wide for easy storage

MCVBCARTY 40”H x 24”W x 24”D \$199⁹⁹ EA ★



MANUAL SCOREKEEPER WITH ADJUSTABLE STAND

- 7” numbers printed on vinyl
- Scores up to 99 for each team
- Two erasable team panels
- PVC stand measures 38”H with a 15” x 15” base
- Converts from floor model to 12”H table top unit

1162448 \$119⁹⁹ EA ★



MANUAL TABLETOP DOUBLE SIDED SCOREBOARD

- 6” numbers for scoring
- 2.5” numbers to score games (0-5 for each side)
- Scores up to 30 for each team
- Double-sided, see the score from front and back
- Folds up for easy transport and storage

MSMLTSCR 7”H x 15”W \$99⁹⁹ EA ★



PORTABLE MANUAL SCOREKEEPER

- 6” score digits
- 2.5” Period/Games digit up to 5
- Scores game up to 99 for each side
- No assembly required
- Lays flat for storage

1196177 11”H x 23”W \$89⁹⁹ EA ★



BSN SPORTS

CARBON WOMEN'S VOLLEYBALL SYSTEM - 3.5"

- Lightweight and high strength carbon fiber uprights exclusively for use at women's height (7'-4 1/8")
- Reinforced lower support with threaded foot for fine adjustment to proper net height
- Complete System PR5000AXX Includes: 3.5" diameter carbon fiber posts, worm drive ratchet, pole pads (specify color), universal VB net, antennas, judge's stand and judge's stand padding (specify color)
- 22 LB Upright Weight
- NFHS, NCAA regulated.
- Ground Sleeves and Floor Plates sold separately

PR6000AXX	System w/o Ground Sleeves	\$7,599 ⁹⁹ SET
PR6000BXX	System w/o Judge's Stand, Padding, & Ground Sleeves	\$6,799 ⁹⁹ SET
PRFLRPLT35	3.5" Ground Sleeves/Floor Covers	\$529 ⁹⁹ SET
PR1235661	Universal Volleyball Net-Kevlar Top	\$549 ⁹⁹ EA ★
PR00826000	Sleeve Adapter-Converts 4" to 3.5"	\$329 ⁹⁹ EA
PR6000	3.5" Standards Only (pr)	\$4,999 ⁹⁹ PR
1457053	Universal Winch	\$399 ⁹⁹ EA



PAD COLOR OPTIONS



Ground Sleeves and Floor Plates sold separately

ADD YOUR SCHOOL LOGO TO ANY BSN SYSTEM PAD!

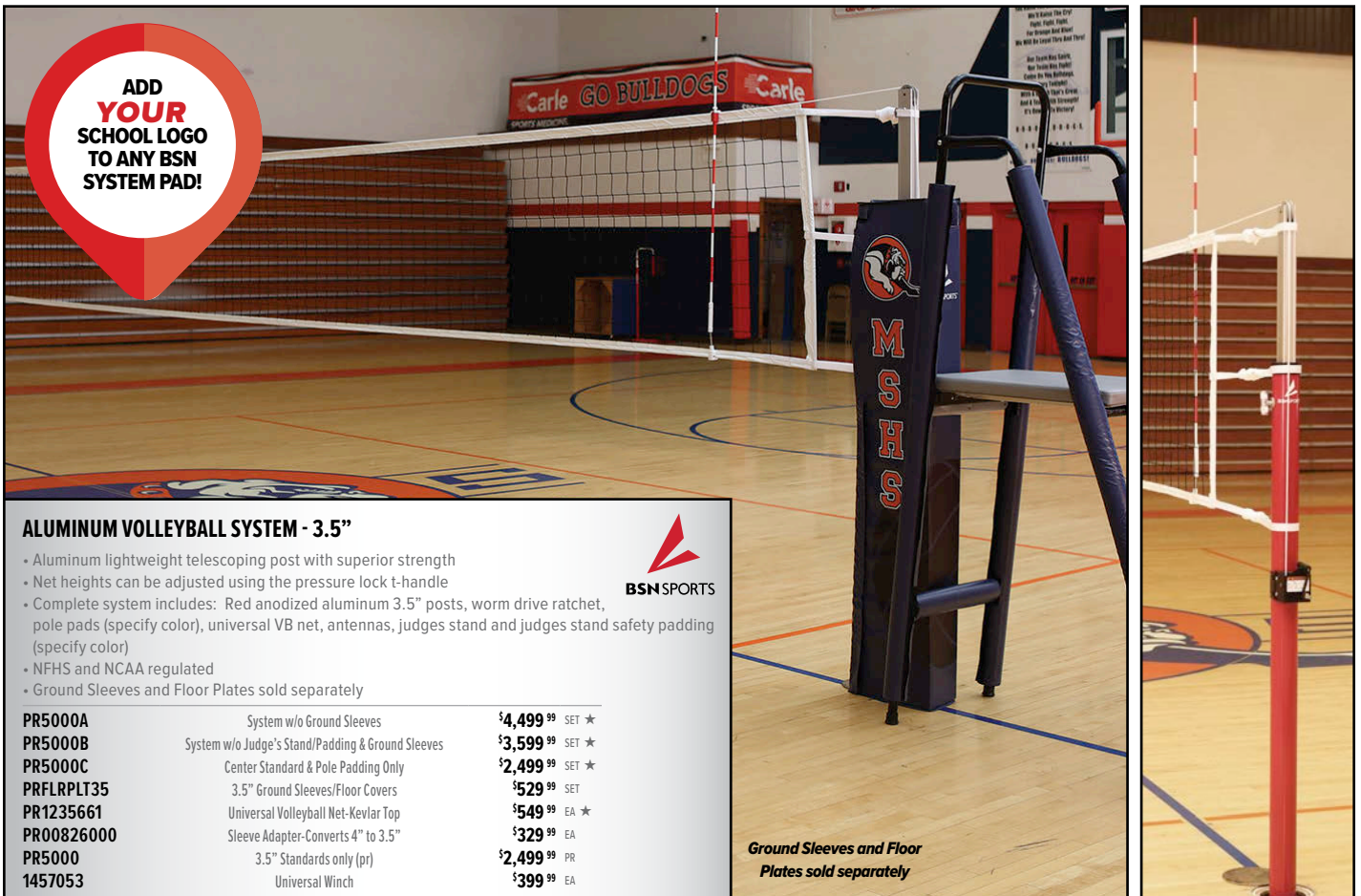

ALUMINUM VOLLEYBALL SYSTEM - 3.5"

- Aluminum lightweight telescoping post with superior strength
- Net heights can be adjusted using the pressure lock t-handle
- Complete system includes: Red anodized aluminum 3.5" posts, worm drive ratchet, pole pads (specify color), universal VB net, antennas, judges stand and judges stand safety padding (specify color)
- NFHS and NCAA regulated
- Ground Sleeves and Floor Plates sold separately

PR5000A	System w/o Ground Sleeves	\$4,499 ⁹⁹ SET ★
PR5000B	System w/o Judge's Stand/Padding & Ground Sleeves	\$3,599 ⁹⁹ SET ★
PR5000C	Center Standard & Pole Padding Only	\$2,499 ⁹⁹ SET ★
PRFLRPLT35	3.5" Ground Sleeves/Floor Covers	\$529 ⁹⁹ SET
PR1235661	Universal Volleyball Net-Kevlar Top	\$549 ⁹⁹ EA ★
PR00826000	Sleeve Adapter-Converts 4" to 3.5"	\$329 ⁹⁹ EA
PR5000	3.5" Standards only (pr)	\$2,499 ⁹⁹ PR
1457053	Universal Winch	\$399 ⁹⁹ EA



Ground Sleeves and Floor Plates sold separately



Ground Sleeves and Floor Plates sold separately



BSN SPORTS

HYBRID VOLLEYBALL SYSTEM - 3"

- Heavy duty steel outer upright with aluminum inner upright
- Telescoping standard with pin-stop preset heights
- Flat black powder coated finish
- Complete system includes: Flat black steel outer/aluminum inner 3" posts, worm drive ratchet, pole pads (specify color), universal VB net, antennas, judges stand and judges stand safety padding (specify color)
- NFHS and NCAA regulated
- Ground Sleeves and Floor Plates sold separately



PR4000A	System w/o Ground Sleeves	\$4,299 ⁹⁹	SET ★
PR4000B	System w/o Judge's Stand/Padding & Ground Sleeves	\$3,499 ⁹⁹	SET ★
PR4000C	Center Standard/Pole Padding Only	\$2,099 ⁹⁹	SET ★
PRFLRPLT30	3" Ground Sleeves/Floor Covers	\$549 ⁹⁹	SET
PR1235661	Universal Volleyball Net-Kevlar Top	\$549 ⁹⁹	EA ★
PR00827300	Sleeve Adapter-Converts 3.5" to 3"	\$349 ⁹⁹	EA
PR4000	3" Standards only (pr)	\$2,299 ⁹⁹	PR
1457053	Universal Winch	\$399 ⁹⁹	EA

PAD COLOR OPTIONS



Ground Sleeves and Floor Plates sold separately

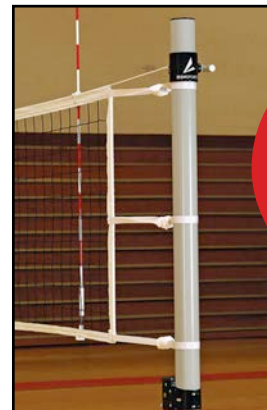

STEEL VOLLEYBALL SYSTEM - 3.5"



- Heavy duty galvanized steel stationary uprights
- Chrome powder coated black gloss collars slide up/down for height adjustment
- Multi-sport system can be used for volleyball, tennis, or badminton
- Complete system includes: Flat grey galvanized steel 3.5" posts, worm drive ratchet, pole pads (specify color), universal VB net, antennas, judges stand and judges stand safety padding (specify color)
- NFHS regulated
- Ground Sleeves and Floor Plates sold separately

PR3000A	System w/o Ground Sleeves	\$3,799 ⁹⁹	SET ★
PR3000B	System w/o Judges Stand/Padding or Ground Sleeves	\$2,999 ⁹⁹	SET ★
PR3000C	Center Standard/Pole Padding Only	\$1,999 ⁹⁹	SET ★
PRFLRPLT35	3.5" Ground Sleeves/Floor Covers	\$529 ⁹⁹	SET
PR1235661	Universal Volleyball Net-Kevlar Top	\$549 ⁹⁹	EA ★
PR00826000	Sleeve Adapter-Converts 4" to 3.5"	\$329 ⁹⁹	EA
PR3000	3.5" Standards only (pr)	\$2,199 ⁹⁹	PR
1457053	Universal Winch	\$399 ⁹⁹	EA



FOLDING JUDGE'S STAND

- Free standing steel, portable judge's stand to use on any sleeved volleyball system
- Black powder coated finish with a grey vinyl padded platform
- Unit folds down enabling entire stand to be flat for storage
- Non-marking casters provide easy transport to any location

PR669100 \$1,099⁹⁹ EA ★



JUDGE'S STAND SOLD SEPARATELY.

JUDGE'S STAND PADDING

- 1 3/8" thick polyethylene tube foam
- 15oz. vinyl covering, available in 14 colors
- Player protection from impact, easy to attach

PRJUDPAD Specify Color \$649⁹⁹ EA



FULLY CUSTOMIZABLE



VOLLEYBALL NET SLEEVE

- Constructed of heavy 15oz. vinyl coated polyester fabric material
- Hook and loop closure attaches to any manufactures net quickly without affecting net play
- Fully customizable with school name and logo

PRNETSLVE0032 \$699⁹⁹ EA



porter WALL STORAGE RACK

- Secures 2 volleyball poles in place
- Holds pole up to 3.5" diameter

PR825 \$299⁹⁹ EA



EQUIPMENT NOT INCLUDED

VOLLEYBALL EQUIPMENT CART

- Constructed 1.5" 14-gauge powder coated steel tubing
- Storage basket is 8"D x 20"W x 5"L
- Transport and store up to 6 poles with other court accessories (balls, nets, pole pads, etc.)
- Includes 4 non-marring swivel casters
- 60"L x 32"W x 42"H

1197372 60 lbs. \$899⁹⁹ EA ★



GRAPHICS AVAILABLE

BSN SPORTS

STANDARD PADS

- 15oz vinyl cover, 1 3/8" thick polyethylene filler
- Hook/Loop attachments
- Pads are cut and hinged to fold neatly around uprights and ratchets to provide a clean look

PRSTAPAD End Pole Pads-Specify Color \$999⁹⁹ PR ★
 PRCTRPAD Center Pole Pad-Specify Color \$599⁹⁹ EA ★

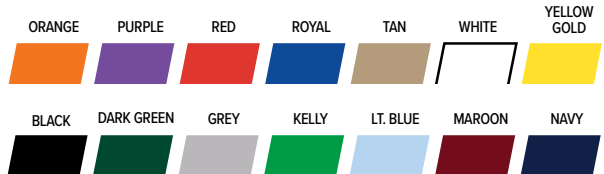

POWER STANDARDS

(FLOOR PLATE REQUIRED)

1. POWER PLAY GAME STANDARD

- 24" heavy wall steel base, with non-marring rubber floor protectors, non-marring wheels, and blue powder coated finish
- 2-3/8" heavy wall galvanized steel uprights with pre-set heights to play men's and women's volleyball, badminton, and tennis
- Includes: 2 safety padded guy wires, 2 floor plate anchors with hand bolts, 2 pulleys and a safety precision worm gear winch
- Designed for competitive play
- Recommended net - SNVBC32Y
- Requires floor anchoring.

ST240PWR 110 lbs. - Pair \$1,199⁹⁹ PR ★ 

2. POWER PLAY CENTER STANDARD

- Use with Power Play Game Standards (ST240PWR) for side by side court play
- Same Specifications as the ST240PWR
- Includes winch

ST240PCS 63 lbs. \$669⁹⁹ EA ★ 



WORM GEAR STRAP WINCH

- Powder coated housing with stainless steel cover
- Low profile handle does not require removal
- Tension strap eliminates cable kinking
- Universal bolt pattern, designed to use with Power Play Game Standard

ZWORMGEARX \$179⁹⁹ EA ★

HEAVYWEIGHT STANDARDS

(RECOMMENDED FOR PE)

3.

24" MULTI-GAME STANDARD

- 24" heavy wall steel base, with non-marring rubber floor protectors, non-marring wheels, and blue powder coated finish
- 2-3/8" heavy wall galvanized steel uprights with pre-set heights to play men's and women's volleyball, badminton, and tennis
- Designed for recreational play
- Recommended net - SNVBC32Y
- Weighted base does not require floor anchoring

ST240S/P 360 lbs. - Pair \$1,299⁹⁹ PR ★ 

24" MULTI-GAME CENTER STANDARD

- Use with Multi-Game Standards (ST240S/P) for side-by-side court play
- Same specifications as ST240S/P

ST240C/S 180 lbs. \$699⁹⁹ EA ★ 

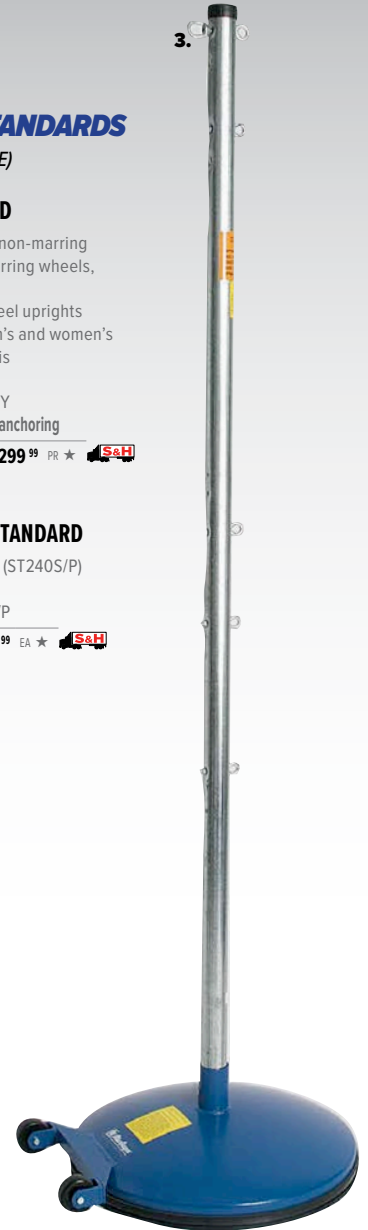

PROTECTIVE BASE PAD

- Vinyl covered bonded foam
- Easy to install with hook-and-loop attachments
- Blue only

1012385 24" Diameter \$219⁹⁹ EA ★
1193572DS 30" Diameter \$259⁹⁹ EA

STANDARD POLE PAD

- Fits poles 3" O.D. or smaller
- 6'H with 2" thick vinyl covered foam and hook and loop fasteners
- Not intended for in-ground outdoor volleyball poles

1012415 Royal Blue Only \$369⁹⁹ PR ★ 





NETS	USES	SIZE/BODY	HEADBAND	BOTTOM	CABLE	PRICE/CODE
	Ultimate Volleyball Net Telescopic Aluminum System AAI Systems	32' x 1m, 3.0mm braided knotted nylon	2" HD white polyester	1 1/4" HD white polyester side pockets; fiberglass dowels w/ 3 intergrated D-Rings white nylon webbing tension straps	34' Aramid fiber top Nylon rope bottom	\$379 ⁹⁹ EA ★ 1235661
	Master Volleyball Net Senoh & most Power VB systems	32' x 1m, 3.5mm braided knotless HTPP	18 oz coated vinyl top	18 oz vinyl w/ fiberglass dowels, 14 oz coated vinyl bottom	45' Aramid fiber top Nylon rope bottom	\$269 ⁹⁹ EA ★ 1297058
	Pro Power Volleyball Net VX2000 System PPS Steel System	32' x 1m, 3.5mm braided knotless nylon	14 oz laminate vinyl top/bottom	14 oz laminate w/ fiberglass dowels	34' PVC coated steel top cable w/ 3' 6" leader cable includes net tension straps	\$259 ⁹⁹ EA ★ 1297065
	Pro Power 2 Volleyball Net Systems w/ Double Ratchets	32' x 3', 2.5 mm polyethylene twisted knotted	2" HD 14 oz vinyl top/bottom	Steel dowels w/ synthetic leather cover 14 oz vinyl	40' L 1/8" thick coated steel top and bottom	\$129 ⁹⁹ EA ★ SNVBSP32Y
	Sport Volleyball Net HS Physical Education ST240PWR	32' x 3', 2mm polyethylene twisted knotted	1.5" HD 14 oz vinyl top w/ 1.5" bottom	10 oz vinyl coated tape	40' L 1/8" thick coated steel top w/ vinyl coated tape bottom	\$89 ⁹⁹ EA ★ SNVBSC32Y
	Recreational Volleyball Net Jr High Phys Ed ST240S/P ST240C/S	25', 27', 30', 32' x 3' Specify length 2mm polyethylene twisted knotted	1.5" HD 10 oz vinyl top	10 oz vinyl coated tape	1/4" thick rope top	\$59 ⁹⁹ EA ★ SNVBR
	Multi-Color Economy Nets Recreational Play	32' x 3' 2 tone polyethylene 2mm twisted knotted	1.5" HD 10 oz vinyl top	10 oz vinyl coated tape	40' L 5/32" thick polyester rope top	\$39 ⁹⁹ EA ★ 1048612
	Economy Volleyball Net Elementary Physical Education	32' x 3', 1.75mm polyethylene twisted knotted	1.5" HD 10 oz vinyl top	10 oz vinyl coated tape	40' L 5/32" thick polyester rope top	\$49 ⁹⁹ EA ★ SNVBE02Y

Sport Write!
COACHING TOOLS
DRY-ERASE BOARDS

- Large format enables entire team to see play
- 2 writing surfaces
- Great pen clip with premium dry erase marker

1383513 12 1/2" H x 16 1/2" W - 2lbs. \$39⁹⁹ EA



BSN SPORTS
VOLLEYBALL SCOREBOOK

- Includes: 24 matches, 5 games per match and simplified instructions.
- NOW INCLUDES RALLY SCORING!!

1111XXXX

\$13⁹⁹ EA

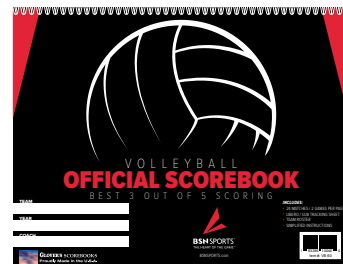



VB NET STORAGE SYSTEM

- Net storage system that prevents nets from getting tangled
- 3 storage options: 1 net, 2 nets or 3 nets

1238822	3 Nets	\$429 ⁹⁹ EA
1238815	2 Nets	\$389 ⁹⁹ EA
1238808	1 Net	\$349 ⁹⁹ EA



NET SETTER CHAIN

- Hang from net to measure the correct height of the volleyball net
- 4 pre-set official net heights for Mens, Womens, Co-ed and Junior play

1238778	\$19 ⁹⁹ EA
---------	-----------------------



VOLLEYBALL NET TENSION STRAPS

- 2" velcro net straps that help secure volleyball net to standards
- Set includes 6 straps

1203486	\$69 ⁹⁹ SET OF 6 ★
---------	-------------------------------



LINESMAN FLAGS

- Set of 4 linesman flags with case
- Deluxe aluminum handles with soft grips
- Flag Size: 12" x 12"

1376640	\$39 ⁹⁹ SET
---------	------------------------



VOLLEYBALL ANTENNA

- White antenna holder is 1" wide complete with velcro strips that secure system to net.
- The antenna slips easily into a pocket for correct positioning on the net.

VBANT	\$79 ⁹⁹ PR ★
-------	-------------------------



FLOOR TAPE APPLICATOR

- Sturdy steel applicator
- Ideal for laying 1" or 2" single sided tape
- Use for straight or curved lines

TAPEMAC	\$89 ⁹⁹ EA ★
---------	-------------------------



FLOOR MARKING TAPE

- Use on any smooth floor surface
- Color Options: **Black, Blue, Green, Gold, Orange, Purple, Red, White.**

FTAP16	1" x 60 Yd.	\$11 ⁹⁹ EA ★
FTAP26	2" x 60 Yd.	\$16 ⁹⁹ EA ★

FLOORMARX™ SET

- Fast drying ink (2min) and cleaning wipes (30 sec)
- One Floor Marker writes for over 250 yards
- Set includes 2 Floor markers, 1 green and 1 blue, and 1 canister of cleaning foot wipes
- Intended for sealed gymnasiums and dance floors, and other non-porous surfaces
- BEFORE FULL APPLICATION, always test on multiple, small, inconspicuous areas of the floor



1454864	\$49 ⁹⁹ SET
---------	------------------------



H2O PERFORMANCE PACK

- Performance Pack includes 5 markers: red, orange, green, blue, and purple
- One canister of foot wipes
- One bag of R&R foot towels (20 towels)

1461860	\$84 ⁹⁹ PACK
---------	-------------------------

porter®

POWR-SAND VOLLEYBALL PACKAGE

- Competition Plus Package Includes: Powr-Sand Standards (pr), Upright Protective Pads (pr), Outdoor Competition Volleyball net, Powr-Select Net Antennas (pr), Fair Height Net Chain, Powr-Sand Judge's Stand, Powr-Sand Judge's Stand Padding, and Sand Rake
- Competition Package includes: Powr-Sand Standards (pr), Upright Protective Pads (pr), Outdoor Competition Volleyball net, Powr-Select Net Antennas (pr), and Fair Height Net Chain
- Judge's stand is only included in the Competition PLUS Package

PR30910	Competition Plus Package	\$5,299 ⁹⁹ EA	
PR30911	Competition Package	\$5,299 ⁹⁹ EA	



PVC WITH NO CAP



GALVANIZED STEEL WITH WRENCH CAP



ROPE CABLE NET SYSTEM UTILIZES GALVANIZED STEEL ROPE CLEATS FOR EASY NET ATTACHMENT.



STEEL CABLE NET SYSTEM INCLUDES HEAVY DUTY STEEL RATCHET WITH REMOVABLE HANDLE.



SPECTRUM 2000 VOLLEYBALL SYSTEM

- Quick set up and completely portable
- Aluminum standards have push button locks for easy height adjustment
- Set includes: 1 3/4" telescopic 2-piece aluminum poles, 3' x 32' sleeve net, 1/4" pull-down guyline system, 10" steel stakes, pre-measured boundary w/corner anchors, winder and storage bag

15 Year Limited Warranty

60790XXX

\$449⁹⁹ SET

OUTDOOR VOLLEYBALL PACKAGES

- 10'H x 2 3/8" O.D. galvanized steel pole inserts 2' into ground sleeves or can be permanently installed in concrete
- Pre-Drilled for volleyball, badminton and tennis
- All weather treated net secures through eye bolts

VBPK1	Steel Top Cable Net - PVC Ground Sleeves/No Cap	\$699 ⁹⁹ SET	★
VBPK2	Steel Top Cable Net/Steel Ground Sleeves/With Cap	\$879 ⁹⁹ SET	★
VBPK3	Rope Top Cable Net/PVC Ground Sleeves/No Cap	\$679 ⁹⁹ SET	★
VBPK4	Rope Top Cable Net/Steel Ground Sleeves/With Cap	\$869 ⁹⁹ SET	★

MONGOOSE WIRELESS VOLLEYBALL SYSTEM

- 2 adjustable high-strength anodized black aluminum posts
- 2 steel in-ground plates
- 2 sand wedge adapters
- 2 blue protective pole pads
- Regulation size net, court boundary line marker, blue nylon carrying bag, and instructions

Lifetime Warranty

1138214 Wireless System \$799⁹⁹ SET



MARK YOUR COURT WHEREVER YOU PLAY!

VOLLEYBALL BOUNDARY MARKERS

- 1/4" heavy-duty polypropylene rope with mid-point net markers, splice protector corner sleeves, nickel-plated corner rings
- Official 30' x 60' court size
- Includes storage winder

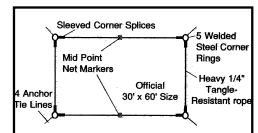

90355YLX

Yellow Only

\$69⁹⁹ EA ★

KNEE PADS



VAPOR ELITE KNEE PADS

- High-density dual layer foam helps cushion against impact
- Articulated padding increases flexibility
- Nike Dri-Fit technology

Color Options: **Black/White, White/Black**

Size: **XS/S, M/L, XL/XXL**

1467039 XS/S, M/L, XL/2XL \$49⁹⁹ EA



VARSITY KNEE PADS

- Shock absorbing foam helps protect against impact
- Protective cushioning wraps the sides of the knee
- Breathable, Nike Dri-Fit technology

Color Options: **Black/White, White/Black**

Size: **XS/S, M/L, XL/XXL**

1467046 XS/S, M/L, XL/2XL \$39⁹⁹ EA



STREAK KNEE PAD

- Protective knee pad with contoured, shock absorbing foam and abrasion resistance for optimal fit and protection
- DRI-Fit fabric to wick sweat away and keep you dry and comfortable
- Lightweight and slim fitting design allows for unrestricted range of motion

Color Options: **Black, White**

1399096 XS/S, M/L, XL/2XL \$29⁹⁹ PR



ESSENTIALS KNEE PADS

Low profile ergonomic high density protective foam pad. Simplified outer design for a minimalistic look. Improved interior DRI-FIT liner is more comfortable. Length: 6.7", Width: 6.25".

Color Options: **Black, White**

Size: **XS/S, M/L, XL/XXL**

1378124 XS/S, M/L, XL/2XL \$24⁹⁹ PR



ARMOUR 2.0 KNEE PADS

Super durable circular knit construction for unmatched comfort, fit & feel. Dual density EVA foam for increased impact protection. Hinged design allows for maximum mobility.

Color Options: **Black, White**

Size: **S/M, MED, LRG.**

UA21140 Adult \$30⁰⁰ PR

UA21180 Youth \$28⁰⁰ PR



MIZUNO LR-6 KNEE PAD

- 50% Polyester with 22% Rayon and 28% Elastic.
- Dynamotion Fit for easy movement
- 6" sleeve length
- Low-rise, no-fold design. Complete knee protection.

Color Options: **Black, White**

MZ480105 S-L \$28⁹⁹ PR

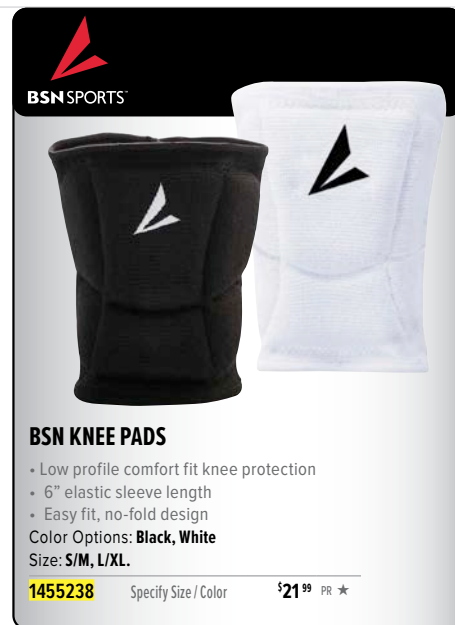

BSN KNEE PADS

- Low profile comfort fit knee protection
- 6" elastic sleeve length
- Easy fit, no-fold design

Color Options: **Black, White**

Size: **S/M, L/XL.**

1455238 Specify Size / Color \$21⁹⁹ PR ★



LIGHTWEIGHT WRESTLING MATS

- Constructed of our tough 24oz. non-slip vinyl and premium grade lightweight foam
- Quick and easy setup, breakdown, and storage
- Fast and easy to move, comes in 1 5/8" or 2" thickness
- Antimicrobial-treated vinyl surface
- Exceeds ASTM F1081/F355 impact protection standards
- 5-year limited warranty, mats are made to order, ships in 9-12 weeks (depending on product availability)
- Mat colors: Royal, Navy, Red, Black, Light Grey, Dk Green, Maroon, Gold, Purple, White, Orange

All logos/lettering are subject to additional charges on all wrestling mats.

5 Year Limited Warranty

1393094	36' x 36' x 1 5/8" (6-6' x 36' sections)	\$7,899 ⁹⁹ EA
1393095	42' x 38' x 1 5/8" (7-6' x 38' sections)	\$9,699 ⁹⁹ EA
1393096	42' x 40' x 1 5/8" (7-6' x 40' sections)	\$10,199 ⁹⁹ EA
1393097	42' x 42' x 1 5/8" (7-6' x 42' sections)	\$10,799 ⁹⁹ EA
1393101	36' x 36' x 2" (6-6' x 36' sections)	\$8,999 ⁹⁹ EA
1393102	42' x 38' x 2" (7-6' x 38' sections)	\$10,999 ⁹⁹ EA
1393103	42' x 40' x 2" (7-6' x 40' sections)	\$11,599 ⁹⁹ EA
1393104	42' x 42' x 2" (7-6' x 42' sections)	\$12,199 ⁹⁹ EA



LIGHTWEIGHT WRESTLING MAT-SINGLE ROLLS

- Constructed of our tough 24oz. non-slip vinyl and premium grade lightweight foam
- Antimicrobial-treated vinyl surface
- Exceeds ASTM F1081/F355 impact protection standards
- Incredibly fast and easy to set up, breakdown, store and move
- 5-year limited warranty
- Choose from 9 mat colors: Royal, Navy, Red, Black, Grey, Dk Green, Maroon, Gold, Purple

5 Year Limited Warranty

1393245	Single Roll-6' x 36' x 1 5/8"	\$1,299 ⁹⁹ EA
1393246	Single Roll-6' x 38' x 1 5/8"	\$1,399 ⁹⁹ EA
1393247	Single Roll-6' x 40' x 1 5/8"	\$1,449 ⁹⁹ EA
1393248	Single Roll-6' x 42' x 1 5/8"	\$1,549 ⁹⁹ EA

HIGH SCHOOL/COLLEGIATE WRESTLING MATS

Wrestling mats are manufactured to meet NCAA specifications. Constructed with lightweight, crack-proof, anti-bacterial/anti-fungal materials, these mats feature durable vinyl PVC outer that is bonded to the foam core. Standard price includes: Single color mat w/ 10' diameter center circle and outer boundary circle, reverse side has 9 practice circles

ADDITIONAL FEATURES:

- Dense, 1" or 1-1/4" thick shock absorbing mat
- Tough poly-vinyl #457 coating
- No cross-seams in official wrestling area, wrestling mats are made to order, ships in 9-12 weeks (depending on product availability)
- Ensolite AAC foam core as used for the NCAA Championships
- Multi-colors, customized insignias & lettering available at additional charge
- 26 color choices: White, Light Grey, Grey, Metallic Silver, Black, Pale Yellow, Light Gold, Metallic Gold, Old Gold, Kelly Green, Medium Green, Dark Green, Red, Orange, Burnt Orange, Light Maroon, Dark Maroon, Chocolate Brown, Turquoise, Sea Green, Columbia Blue, Bright Blue, Royal Blue, Penn State Blue, Navy Blue, Purple
- Mats may be divided into multiple sections for easy handling
- NCAA rules require a mat size of 42' x 42' with a minimum wrestling circle of 32'. High School regulation size is 38' x 38' with a minimum 28' wrestling circle.

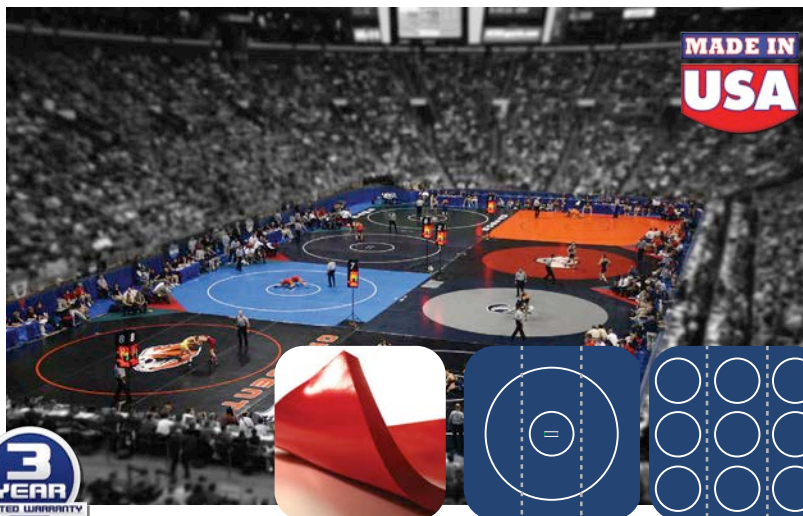

6426XXXX	1" Thick Material	\$12 ⁹⁹ SQ.FT	S&H
6428XXXX	1-1/4" Thick Material	\$13 ⁹⁹ SQ.FT	S&H

SHOT SLED

- Weighs only 43 pounds
- Easy for one person to move
- Collapses for easy storage and transportation
- Made in the USA
- Utilizes industry leading Resilite Foam Pads
- Can be used Solo or with a Training Partner
- Welded foot pegs to ensure a stable base
- Slides on all kinds of wrestling mats without damage
- Comes in Red or Black Pad Options
- Ships via Freight Carrier

Color Options: **Black, Red**
Size: **OSFA.**

1461553	Select Color	\$1,599 ⁹⁹ EA
---------	--------------	--------------------------

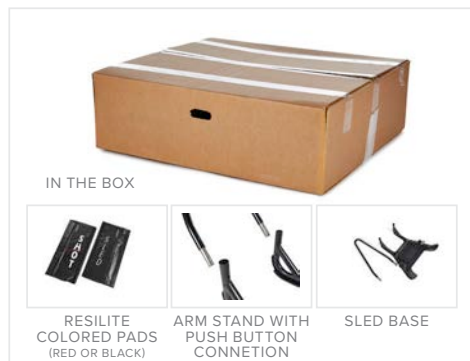



ORIGINAL SHOWER GEL

- Provides a smooth, rich lather to remove dirt, grime, and sweat and rinses clean
- Provides a spectrum of benefits derived from tree and eucalyptus oils
- Moisturizes and soothes itchy, scratchy, dry, inflamed skin
- 100% Organic ingredients, Vegan, and Non-GMO

1460677 1 Gallon Size **\$99.99** EA



LARGE DISINFECTANT TABLETS

- EPA-registered bleach alternative that is less corrosive than traditional bleach
- Strong, hypochlorous acid base effective against a broad range of microorganisms
- Surface and user-friendly tablet delivers accurate strength solution every time with no measuring
- Offers 3-day shelf life when diluted into a closed container and 3-year shelf life in tablet form
- Less irritating odor than harsh chemicals

1460678 1 Gallon Size-256 tablets **\$259.99** EA



ORIGINAL BODY WIPES

- Intended for skin cleansing when you are unable to shower
- Designed to be portable for easy use but durable enough for heavy use
- Provides a spectrum of benefits derived from tea tree and eucalyptus oils
- Natural with no parabens, sulfates, SLS, triclosan, dyes, or fragrances

1460679 40-Count Canister **\$119.99** EA

MATT-KLEEN™ ALL PURPOSE DISINFECTANT CLEANER

- Helps stop the spread of skin diseases and infections
- Ideal for wrestling and gymnastic mats, training tables and shower floors
- Highly concentrated; 2 oz. makes one full gallon

1092479 Gallon **\$129.99** EA



ZEHN-X WIPES

- These oversized wipes (8' x 6") are made with natural ingredients for safe and effective cleansing
- Made with rayon mesh for strength, aloe vera and tree oil for added protection and antibacterial properties
- Includes Benzalkonium Chloride (BZK) which is completely alcohol free
- BZK provides the antimicrobial action

1459126 180-Count Tub **\$18.99** EA
1459127 1200-Count Roll **\$64.99** EA



WHIZZER®

- Multipurpose concentrate kills HIV-1 (AIDS virus), MRSA, Hepatitis B & C, and other viruses. Kills strep, staph and fungus germs on contact.
- Cleaner, fungicide, mildewstat, virucide and deodorizer - all in one. Comes complete with 2 FREE Pint spray bottles.
- One ounce of concentrate mixed with water makes a gallon of full-strength disinfectant. 128 dilutions per gallon.
- Fast. Apply directly to mats, floors, walls, training tables, locker rooms, or personal items. Just wipe dry.

30 Day Limited Warranty

MU230201 1 Gallon + 2 FREE Pint Spray Bottles **\$119.99** CASE



50 PERSON FIRST AID KIT

- 9" x 9" x 2 3/8" Plastic Case with Waterproof Gasket and Wall Mount/Handle
- Kit Contents: (2) 1/2" x 5yd Adhesive Tape, (2) Instant Cold Pack, (10) Antiseptic Towelettes, (2 pair) Disposable Gloves, (10) 1/32oz First Aid Cream, (8) Fingertip Bandages, (8) Knuckle Bandages, (2) Eye Wash Bottles, (100) 1" x 3" Adhesive Strips, (2) XL Adhesive Strips, (3) Insect Sting Relief, (1) 5" x 9" Combine Pad, (12) 2" x 2" Gauze Pads, (12) 3" x 3" Gauze Pads, (4) Oval Eye Pads, (2) Triangular Bandages, (2) 2" x 4yd. Conforming Bandage, (1) 4" x 2 yd. Conforming Bandage, (1) 3" Elastic Bandage, Scissors and Forceps

1202113 OSHA Compliant **\$89.99** EA



COACH'S TEAM FIRST AID KIT

- Designed by athletic trainers to meet the first aid needs of competitive sports
- Contents: (2) Instant Cold Packs, (3) Knuckle Bandages, (5) Butterfly Bandages, (3) After Bite Sting Relief, (6) Tongue Depressors, (1) Tuf-Skin™ Tape, (1) Tape Underwrap, (12) Antiseptic Towelettes, (10) 3" x 3" Gauze Pads, (3) Fingertip Bandages, (1) Scissors, (5) Antibiotic Cream, (1) Sports Injury Care Handbook, (1) Sam Finger Splint, (5) Acetaminophen, (10) 3/4" x 3" Bandages, (5) 2" x 4" Bandages, (6) Alcohol Prep Pads, (6) Latex Gloves, (1) 3" Elastic Wrap, (1) Skin Lube, (1) Triangle Bandage

1089332 14.5" x 10.25" x 14.25" **\$129.99** EA



MATT-KLEEN™ ALL PURPOSE DISINFECTANT CLEANER

- Helps stop the spread of skin diseases and infections
- Ideal for wrestling and gymnastic mats, training tables and shower floors
- Highly concentrated; 2 oz. makes one full gallon



1092479 Gallon \$129.99 EA



WHIZZER®

- Multipurpose concentrate kills HIV-1 (AIDS virus), MRSA, Hepatitis B & C, and other viruses. Kills strep, staph and fungus germs on contact.
- Cleaner, fungicide, mildewstat, virucide and deodorizer - all in one. Comes complete with 2 FREE Pint spray bottles.
- Economical. One ounce of concentrate mixed with water makes a gallon of full-strength disinfectant. 128 dilutions per gallon.
- Fast. Apply directly to mats, floors, walls, training tables, locker rooms, or personal items. Just wipe dry.

30 Day Limited Warranty

MU230201 1 Gallon + 2 FREE Pint Spray Bottles \$119.99 CASE



SUPER BANDS

- Seamless latex rubber prevents breakage
- Band stretches to create constant tension that targets muscles throughout entire movement
- Color-coded to indicate resistance levels



1455154	Super Light	\$15.99 EA
1455155	Ultra Light	\$21.99 EA
1455156	Light	\$26.99 EA
1455157	Medium	\$32.99 EA
1455158	Heavy	\$41.99 EA
1455159	Ultra Heavy	\$67.99 EA
1457082	Super Heavy	\$89.99 EA

ZEHN-X WIPES

- These oversized wipes(8' x 6") are made with natural ingredients for safe and effective cleansing
- Made with rayon mesh for strength, aloe vera and tree oil for added protection and antibacterial properties
- Includes Benzalkonium Chloride(BZK) which is completely alcohol free
- BZK provides the antimicrobial action

1459126	180-Count Tub	\$18.99 EA
1459127	1200-Count Pkg	\$64.99 EA



LOCK-JAW COLLAR

- Solid nylon injection molded frame and injection molded pads
- Single-action cam lock securely clamps the collar to the bar
- For use with Olympic bars

1379947 Black Only \$49.99 PR



LOCK-JAW PRO COLLAR

- The larger lever and SPRING LOADED SNAP LATCH ensures easy installation and removal of the collar
- The exceptional clamping force keeps the weights secured
- The PRO is for serious lifters, high-impact workouts, and anytime bumper plates are used on a bar

1395572 Black Only \$51.99 PR



CHROME SPRING COLLAR

- For use with Olympic bars

1015911 \$29.99 PR ★



VERTICAL OLYMPIC BAR HOLDER

- Holds 8 Olympic style bars securely in a minimal amount of space
- Horns have nylon sleeves to protect bars
- 16" diameter x 3/4" solid steel base with black powder coated finish

20028055 42 lbs. \$229.99 EA ★



OLYMPIC-STYLE TRICEP BOMBER

- Constructed of 1" chrome stock
- For use with Olympic-style plates
- Includes wrenchless collars
- Weight plates sold separately

CHTRICOL \$199.99 EA ★



OLYMPIC TRAP/HIP BAR

- Dual high/low handle design
- For use with Olympic-style plates
- 57"L x 25"W x 6"H - 60lbs.

1455250 \$399.99 EA ★



LAND MINE TRAINER

- Made of heavy-duty 11 gauge black powder coated steel
- Perform dynamic movements and exercises simply by inserting any Olympic-size bar (not included) into the 10" pivoting sleeve
- 5" lower tube inserts into any standard Olympic plate to create an anchor/base

1377173 \$95.99 EA



CAMBERED SQUAT BAR

- This bar allows squats to be done in a more vertical posture, producing more intense quadricep involvement
- Cambered end design relieves lower back stress normally associated with a traditional back squat
- All steel design with padded shoulder harness
- 2000 lb. maximum capacity

PMWT129 5"H x 16"W x 92.5"L - 66 lbs \$599.99 EA



OLYMPIC WEIGHT SETS

- All sets include:
- 28.5mm (1.12") diameter grip x 2.2m (86.6") long Olympic bar made to AAU/IWF specifications with 50mm (1.96") diameter sleeves
 - Bronze bushings for smooth sleeve rotation
 - Olympic grip plates with grey hammertone, acrylic finish
 - One pair of chrome spring collars

Economy 300 Lb. Weight Set

- Includes 700 lb. capacity chrome bar and spring collars
- 14 Olympic grip plates - 2/45's, 2/35's, 2/25's, 2/10's, 4/5's, 2/2.5's

1035636 \$839⁹⁹ SET ★

300 LB. Standard Weight Set

- Includes 1000 lb. capacity black zinc bar with chrome sleeves and spring collars
- 14 Olympic grip plates - 2/45's, 2/35's, 2/25's, 2/10's, 4/5's, 2/2.5's

WSETS310 \$949⁹⁹ SET ★

300 Lb. Deluxe Weight Set

- Includes 1500 lb. capacity black oxide bar and spring collars
- 14 Olympic grip plates - 2/45's, 2/35's, 2/25's, 2/10's, 4/5's, 2/2.5's

CHCOS310 \$1,099⁹⁹ SET ★

400 Lb. Olympic Set

- Includes 1500 lb. capacity black oxide bar and spring collars
- 18 Olympic grip plates - 4/45's, 2/35's, 2/25's, 2/10's, 6/5's, 2/2.5's

CHCOS400 \$1,299⁹⁹ SET ★

500 Lb. Olympic Weight Set

- Includes 1500 lb. capacity black oxide bar and spring collars
- 22 Olympic grip plates - 6/45's, 2/35's, 2/25's, 2/10's, 8/5's, 2/2.5's

CHCOS500 \$1,499⁹⁹ SET ★



RUBBER COATED OLYMPIC GRIP PLATE

- Will not crack, chip, flake, peel, rust or tear like painted cast iron plates
- Prevents damage to floors, upholstery and will not dent or scratch equipment
- Reduces weight room noise
- Set includes: 1000 lb. capacity Olympic bar, 2 each 45 lb, 35 lb, 25 lb, 10 lb, 2.5 lb, 4 each 5 lb rubber coated grip plates and a pair of 2" Muscle Clamps (Black)

1272550	2.5 lb.	\$14 ⁹⁹ EA ★	1272581	25 lb.	\$99 ⁹⁹ EA ★
1272567	5 lb.	\$24 ⁹⁹ EA ★	1272598	35 lb.	\$124 ⁹⁹ EA ★
1272574	10 lb.	\$42 ⁹⁹ EA ★	1272604	45 lb.	\$159 ⁹⁹ EA ★

300 lb. set with 1000 lb. Capacity Bar

1256574 \$1,249⁹⁹ SET ★



OLYMPIC GRIP PLATES

- All plates have a durable, grey hammertone, acrylic finish

1272475	2.5 lb.	\$9 ⁹⁹ EA ★	1272512	35 lb.	\$89 ⁹⁹ EA ★
1272482	5 lb.	\$15 ⁹⁹ EA ★	1272529	45 lb.	\$119 ⁹⁹ EA ★
1272499	10 lb.	\$28 ⁹⁹ EA ★	1272536	100 lb.	\$249 ⁹⁹ EA ★
1272505	25 lb.	\$64 ⁹⁹ EA ★			



OLYMPIC COMPETITION BUMPER BLACK

- Will not crack, chip, flake, peel, rust or tear like painted cast iron plates.
- Prevents damage to floors, upholstery and will not dent or scratch equipment.
- 32.8 feet factory drop test passed 20,000 drops.
- 450mm diameter steel ring inserts.
- Zinc coated steel disc insert.

1459633	25lb	\$179 ⁹⁹ EA ★
1459634	35lb	\$209 ⁹⁹ EA ★
1459635	45lb	\$249 ⁹⁹ EA ★
1459636	55lb	\$269 ⁹⁹ EA ★



OLYMPIC URETHANE BUMPER PLATE

- Will not crack, chip, flake, peel, rust or tear like painted cast iron plates
- Prevents damage to floors, upholstery and will not dent or scratch equipment. Reduces weight room noise
- 32.8 feet factory drop test passed 20,000 drops
- 450mm diameter steel ring inserts

1459637	10lb	\$135 ⁹⁹ EA ★
1459638	25lb	\$199 ⁹⁹ EA ★
1459639	35lb	\$259 ⁹⁹ EA ★
1459640	45lb	\$299 ⁹⁹ EA ★
1459641	55lb	\$349 ⁹⁹ EA ★



OLYMPIC RUBBER PLATE BLACK

- Will not crack, chip, flake, peel, rust or tear like painted cast iron plates
- Prevents damage to floors, upholstery and will not dent or scratch equipment. Reduces weight room noise
- 32.8 feet factory drop test passed 20,000 drops
- 450mm diameter steel ring inserts

1459642	10lb	\$44 ⁹⁹ EA ★
1459643	15lb	\$55 ⁹⁹ EA ★
1459644	25lb	\$89 ⁹⁹ EA ★
1459645	35lb	\$109 ⁹⁹ EA ★
1459646	45lb	\$139 ⁹⁹ EA ★
1459647	55lb	\$169 ⁹⁹ EA ★



OLYMPIC STYLE BARS

- 1453179 Elite level bar with hard chrome 1 pc sleeves, 3 diamond knurls with dual grip markings, & over 200,000 PSI strength
- All bars are made of high-tensile chrome-molybdenum steel
- All bars have bronze bushings for smooth sleeve rotation and no end screws
- 1101247 features special center knurling, made especially for power lifters

1. 1453179	86" Black Chrome - 1500 lb. Capacity	\$499 ⁹⁹ EA ★ S&H
2. 1101247	86" Zinc Plated - 1500 lb. Capacity	\$424 ⁹⁹ EA ★ S&H
3. 1101248	86" Black Oxide - 1500 lb. Capacity	\$424 ⁹⁹ EA ★ S&H
4. 1101249	86" Black Zinc with Chrome Sleeves - 1000 lb. Capacity	\$339 ⁹⁹ EA ★ S&H
5. CHCOB760	60" Chrome Plated - 700 lb. Capacity	\$275 ⁹⁹ EA ★ S&H
6. 1101250	72" Aluminum Technique Bar - 200 lb. Capacity	\$259 ⁹⁹ EA ★ S&H
7. CHCOCBXX	Olympic 47" EZ Curl Bar	\$169 ⁹⁹ EA ★ S&H
8. CHSNPXXX	Bar Wrap Pad	\$22 ⁹⁹ EA ★

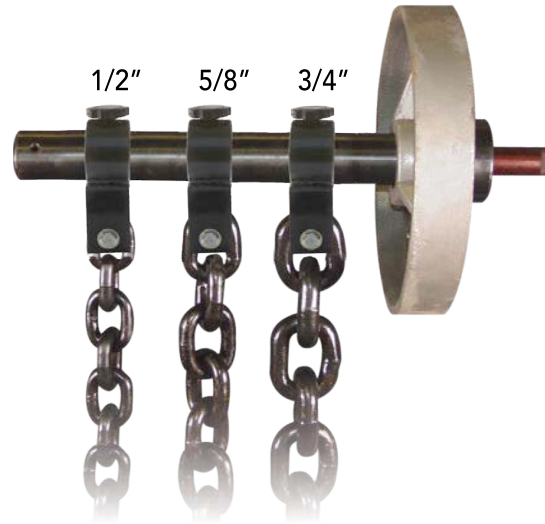

WEIGHT LIFTING CHAINS

- Helps zero-out momentum near lockout for a more effective lift.
- No more coasting as you reach the top of your lifts! Each link provides consistent and accumulated resistance as it's lifted off the floor
- Sold in pairs, each 60"L, with black powder coated bar collars

30 Day Limited Warranty

1460276	1/2" 25 lbs	\$179 ⁹⁹ PR
1460277	5/8" 45 lbs	\$215 ⁹⁹ PR
1460278	3/4" 55 lbs	\$269 ⁹⁹ PR



POWER ROPE ANCHOR STATION

- Use indoors or outside
- Accommodates up to 12 users at one time
- Solid rubber bottom for floor protection
- Add up to 4 - 45 lb. Olympic weight plates for maximum stability
- All welded, all silver powder coated steel construction
- 6.5"H x 23.5"W x 23.5"D - 32 lbs.
- Power ropes and weight plates sold separately

1375090 \$299⁹⁹ EA ★



FITNESS POWER ROPES

- Various lengths and diameters to enhance the overall work-out experience
- Great for grip strength, stamina and overall conditioning
- Ideal for upper body and core exercises

1369620	1.5"Ø - 30'L	\$189 ⁹⁹ EA ★
1369621	1.5"Ø - 40'L	\$239 ⁹⁹ EA ★
1369622	1.5"Ø - 50'L	\$271 ⁹⁹ EA ★
1369624	2"Ø - 30'L	\$284 ⁹⁹ EA ★
1369625	2"Ø - 40'L	\$339 ⁹⁹ EA ★
1369626	2"Ø - 50'L	\$389 ⁹⁹ EA ★





SOLID HEX DUMBBELLS

- Solid cast iron with durable, grey hammertone, acrylic finish
- Straight handles with deep set knurling for functional performance
- Now sold as each, not pairs

1152051	3 lb.	\$11 ⁹⁹ EA ★	1152063	60 lb.	\$139 ⁹⁹ EA ★
1152052	5 lb.	\$18 ⁹⁹ EA ★	1152064	65 lb.	\$149 ⁹⁹ EA ★
1152053	10 lb.	\$25 ⁹⁹ EA ★	1152065	70 lb.	\$169 ⁹⁹ EA ★
1152054	15 lb.	\$38 ⁹⁹ EA ★	1152066	75 lb.	\$179 ⁹⁹ EA ★
1152055	20 lb.	\$52 ⁹⁹ EA ★	1152067	80 lb.	\$189 ⁹⁹ EA ★
1152056	25 lb.	\$62 ⁹⁹ EA ★	1152068	85 lb.	\$199 ⁹⁹ EA ★ S&H
1152057	30 lb.	\$72 ⁹⁹ EA ★	1152069	90 lb.	\$209 ⁹⁹ EA ★ S&H
1152058	35 lb.	\$82 ⁹⁹ EA ★	1152070	95 lb.	\$219 ⁹⁹ EA ★ S&H
1152059	40 lb.	\$104 ⁹⁹ EA ★	1152071	100 lb.	\$229 ⁹⁹ EA ★ S&H
1152060	45 lb.	\$109 ⁹⁹ EA ★	1390919	5-50 lb. Set	\$1,199 ⁹⁹ SET ★ S&H
1152061	50 lb.	\$119 ⁹⁹ EA ★	1390921	55-100 lb. Set	\$3,199 ⁹⁹ SET ★ S&H
1152062	55 lb.	\$134 ⁹⁹ EA ★			



RUBBER ENCASED SOLID HEX DUMBBELLS

- Permanently attached cast iron heads are encased in maintenance free virgin rubber
- Ergonomically designed solid steel handle for comfort and safety
- Handles are knurled and chrome plated; will not peel or chip

20028384EA	3 lb.	\$19 ⁹⁹ EA ★	20028387EA	60 lb.	\$184 ⁹⁹ EA ★
20028375EA	5 lb.	\$26 ⁹⁹ EA ★	20028388EA	65 lb.	\$199 ⁹⁹ EA ★
20028376EA	10 lb.	\$45 ⁹⁹ EA ★	20028389EA	70 lb.	\$215 ⁹⁹ EA ★
20028377EA	15 lb.	\$57 ⁹⁹ EA ★	20028390EA	75 lb.	\$229 ⁹⁹ EA ★
20028378EA	20 lb.	\$72 ⁹⁹ EA ★	20028391EA	80 lb.	\$244 ⁹⁹ EA ★
20028379EA	25 lb.	\$82 ⁹⁹ EA ★	20028392EA	85 lb.	\$259 ⁹⁹ EA ★ S&H
20028380EA	30 lb.	\$92 ⁹⁹ EA ★	20028393EA	90 lb.	\$274 ⁹⁹ EA ★ S&H
20028381EA	35 lb.	\$114 ⁹⁹ EA ★	20028394EA	95 lb.	\$289 ⁹⁹ EA ★ S&H
20028382EA	40 lb.	\$129 ⁹⁹ EA ★	20028395EA	100 lb.	\$299 ⁹⁹ EA ★ S&H
20028383EA	45 lb.	\$139 ⁹⁹ EA ★	1390920	5-50 lb. Set	\$1,499 ⁹⁹ SET ★ S&H
20028385EA	50 lb.	\$154 ⁹⁹ EA ★	1390922	55-100 lb. Set	\$3,499 ⁹⁹ SET ★ S&H
20028386EA	55 lb.	\$169 ⁹⁹ EA ★			



ADJUSTABLE DUMBBELL RACK

- Cradle width is adjustable during assembly to accommodate an inside handle length between 4 1/2" and 5 3/8"
- Cradles are black UHMW polyethylene
- 2" x 3" 11-gauge steel frame construction with silver powder coated finish
- Dumbbells not included

811100 12 Pair Rack - 36"H x 24"D x 70"L \$799⁹⁹ EA ★ **S&H**



PRO COMMERCIAL SETS

- Urethane Coated Steel Plates
- Zytel Pin (Pro 50/90/125)
- Stainless Steel Hardware
- Stand Included (Pro 50, 90, 125/175)
- Knurled Steel Grip (Pro 50 & 90)
- TPR Contoured Grip (Pro 125/175)
- 1 Year Commercial Limited Warranty
- Footprint on Stand : 21.5" x 25"

1461802	50 lbs	\$1,329 ⁹⁹ PR
1461803	90 lbs	\$2,155 ⁹⁹ PR
1461804	125 lbs	\$2,603 ⁹⁹ PR



UPRIGHT DUMBBELL STORAGE RACKS

- Space saving design with maximum storage capacity
- Accommodates most styles of dumbbells
- 42" High with 9" X 19" base
- Dumbbells not included

1137563	2-Sided - Holds 8 Pair	\$289 ⁹⁹ EA ★ S&H
1137574	4-Sided - Holds 13 Pair	\$429 ⁹⁹ EA ★ S&H





CHAMPION
BARBELL™



MULTI-BENCH

- Adjusts to decline, flat or incline positions
- Constructed of 2" x 3" heavy wall steel tubing
- Pads constructed of 2.5" high density foam with Black marine grade vinyl
- Padded leg support for added stability
- 20.5"H x 26"W x 62.5"D - 68 lbs.

601102

\$469⁹⁹ EA ★



WHEELED ADJUSTABLE WEIGHT BENCH

- 7 adjustments from 10 degrees decline to 80 degrees incline
- 5 seat height adjustments
- Constructed of 2" x 3" heavy wall steel tubing
- Pads are 2.5" high density foam with Black marine grade vinyl
- 20"H x 23"W x 54"D - 100 lbs.

815102

813702

No Spotter's Platform
With Spotter's Platform

\$729⁹⁹ EA ★

\$799⁹⁹ EA ★



ADJUSTABLE CURL BENCH

- Constructed of 2" x 3" heavy wall steel tubing
- Fully adjustable arm pad to accommodate different sized users
- Pads are 2.5" high density foam covered in Black marine grade vinyl
- 32.5"H x 28"W x 41"D - 63 lbs.

600200

\$399⁹⁹ EA ★

FLAT BENCH

- Great for dumbbell flies, rows, pullovers and tricep extensions
- Constructed of 2" x 3" heavy wall steel tubing
- Pads are 2.5" high density foam with Black marine grade vinyl
- Includes wheels for mobility
- 19.5"H x 21"W x 51.5"D - 50 lbs.

600902

\$349⁹⁹ EA ★



ADJUSTABLE INCLINE BENCH WITH SPOTTERS PLATFORM

- Constructed of 2" square heavy wall steel tubing
- Ideal for developing deltoids and upper pectorals
- Pad is 10"W x 42"L and adjusts from 36° to 56° and is constructed of 2.5" high density foam with 40 oz. Black marine grade vinyl
- Includes spotter's platform
- 45"H x 48"W x 48"D - 140 lbs.

812702

\$899⁹⁹ EA ★



FIELD HOUSE COMPETITION BENCH

- Constructed of 3" x 3" and 2" x 3" heavy wall steel tubing for maximum stability with heavy weights
- Pad is constructed of 2.5" high-density foam with 40 oz. Black marine grade vinyl
- Equipped with lower safety bar rests
- 44"H x 49"W x 52"D - 120 lbs.

814402

\$649⁹⁹ EA ★



STANDARD BENCH PRESS

- Constructed of 1.5" square heavy wall steel tubing
- Pad is constructed of 2.5" high density foam covered in 40 oz. Black marine grade vinyl
- Equipped with lower safety bar rests
- 44"H x 45"W x 48"D - 72 lbs.

814002

\$499⁹⁹ EA ★

POWER RACKS

- Constructed of 3" x 3" and 2" x 3" heavy wall silver powder coated steel tubing
- 10 weight storage horns with protective wear sleeves and rubber bump stops
- Easily adjustable J-Hook bar catches and safeties with UHMW polyethylene bar guards
- Includes a multi-grip pull up bar and multiple resistance band attachments
- Double Half Rack includes 2 bar storage holders
- Full Power Rack: 96"H x 48"W x 80"D - 460 lbs.
- Double Half Rack: 96"H x 48"W x 91"D - 606 lbs.
- Half Rack: 96"H x 48"W x 57"D - 368 lbs.
- Power lift platform is 8' x 8' with a steel frame and 3/4" rubber top
- A 1 1/2" plywood sub floor consisting of 4 sheets of 3/4" plywood provides a solid non-skid, noise absorbing surface (Plywood is not included with the platform.)
- Accessories sold separately.



J-Hook Bar Catch



Resistance Band Attachments

FULL POWER RACK

813900

\$2,249⁹⁹ EA ★



Bar Storage Sleeve

DOUBLE SIDED HALF RACK

817000

\$3,199⁹⁹ EA ★



J-Hook Bar Catch



Resistance Band Attachments

HALF POWER RACK

816900

Half Rack Only - Floor Mount

\$1,999⁹⁹ EA ★



4-WAY MULTI-FUNCTION GYM

- Four stations for every aspect of your workout
- Used for chest/shoulder press, leg extension, lat pull down and low row
- 83.5"H x 48"W x 75"L - 537 lbs.

156002 \$2,899⁹⁹ EA ★ **S&H**



POWER RACK

- Constructed of 2" x 3" heavy wall steel tubing
- Adjustable 1" solid rod safety bars
- Includes pull up bar
- 24" Lifting area between uprights
- 92"H x 48"W x 42"D - 245 lbs.

810900 \$899⁹⁹ EA ★ **S&H**



SMITH MACHINE

- Constructed of 2" X 3" heavy wall steel tubing
- 7'L - 700 lb capacity bar rotates on precision roller bearings
- Bar uses precision linear bearings to glide friction free on 1" solid case hardened rods
- Solid steel peg and hook safety catch system with separate adjustable safety stops spaced every 7 inches
- Includes 8 weight storage horns
- 84"H x 71.5"W x 68"D - 310 lbs.

815802 \$2,799⁹⁹ EA ★ **S&H**

MULTIFIT SYSTEM

- Perform 11 different exercises in 7 workout stations
- Constructed of 2" square heavy wall steel tubing with a silver powder coated finish (lifetime warranty on welds)
- Built in steps for Chin, Dip & Knee Raise
- Pads are 2.5" high density foam with 40 oz. Black marine grade vinyl

815002 \$1,899⁹⁹ EA ★ **S&H**



PLATE LOADED INCLINE ROWER

- Constructed of 2" square heavy wall steel tubing
- Olympic plate loaded rower designed to develop the rhomboids, trapezius, anterior deltoids and biceps
- Comfortable chest pad covered with durable Black marine grade vinyl
- Swivel handle bar for proper support and angle while doing heavy lifting and strength training
- 48"H x 27"W x 80"L - 135 lbs.

813002 \$599⁹⁹ EA ★ **S&H**



PLATE-LOADED LAT PULLDOWN/LOW ROW COMBO

- Constructed of 2" square heavy wall steel tubing
- Includes rowing attachment, 20" bar and 48" lat bar
- Equipped with height adjustable seat and knee rollers
- Pad is constructed of 2.5" high-density foam with 40 oz. Black marine grade vinyl
- 86"H x 30"W x 65"L - 185 lbs.

814902 \$1,299⁹⁹ EA ★ **S&H**

CABLE ATTACHMENTS

- | | | |
|--------------------|--|---------------------------|
| 1. CHLBPROX | 30" Pro-Style Lat Bar | \$64 ⁹⁹ EA ★ |
| 2. CHLB481X | 48" x 1" Lat Bar | \$79 ⁹⁹ EA ★ |
| 3. CHLBHNDL | Single Chrome Handle | \$23 ⁹⁹ EA ★ |
| 4. CHLB20RT | 20" Rotating Straight Bar | \$41 ⁹⁹ EA ★ |
| 5. CHLBTRXX | Nylon Tricep Rope | \$42 ⁹⁹ EA ★ |
| 6. CHLBVPRS | V Shaped Press Down Bar | \$34 ⁹⁹ EA ★ |
| 7. CHLBMLTI | Revolving Multi-Exercise Bar | \$54 ⁹⁹ EA ★ |
| 8. 1101263 | Nylon Ankle Strap | \$29 ⁹⁹ EA ★ |
| 1382829 | Deluxe Cable Attachment Package (1 each of all of the above) | \$319 ⁹⁹ SET ★ |

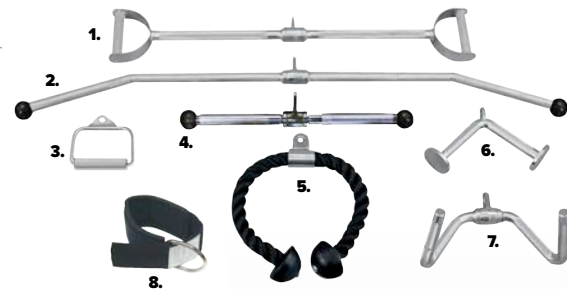

CABLE ATTACHMENT PACKAGE

- PACKAGE INCLUDES 1 OF EACH
- 20" rotating straight bar
 - Tricep lat rope
 - "V" shaped press down bar

1051377 \$89⁹⁹ PACK ★

SAVE 15% NOW \$89⁹⁹





POWER RAM SLED HACK-MACHINE/LEG PRESS

- This three-way ram sled develops all muscle groups from the lower back and down, including hips, thighs and calves
- 4 start-stop locations to accommodate various height users
- The 85 lb. carriage glides smoothly at a 45 degree angle on 4 precision linear bearings
- Constructed of 2" x 3" heavy wall steel tubing
- Pads are constructed of 2.5" high density foam with Black marine grade vinyl
- Adjustable backrest/footrest to ensure proper angle for exercises
- Equipped with safety catches that can be engaged by user from any position
- 51"H x 32.5"W x 90"D - 400 lbs.

816702

\$2,799⁹⁹ EA ★ 



FIELD HOUSE LEG PRESS

- Constructed of 2" x 3" heavy wall steel tubing
- Pads are constructed of 2.5" high density foam with Black marine grade vinyl
- Delivers a full range of motion with smooth precision pillow block bearings
- Heavy duty rubber bump stops for quiet operation
- Includes 2 weight storage horns with protective sleeves
- 1200 lb. weight capacity
- 59"H x 32"W x 84"L - 480 lbs.

814202

\$2,499⁹⁹ EA ★ 



GLUTE/HAM MACHINE

- Constructed of 2" x 3" heavy wall steel tubing
- Pads are constructed of 2.5" high density foam with Black marine grade vinyl
- Strengthens lower back, hamstrings and core
- Foot pads adjust vertically and horizontally to fit all size users
- Equipped with knee pads to aid with mounting and dismounting
- Includes rear handle used for reverse hyper extensions
- 42"H x 34"W x 60"L - 196 lbs.

814102

\$999⁹⁹ EA ★ 



LEG EXTENSION/CURL MACHINE

- Constructed of 2" heavy wall steel tubing
- Pads are constructed of 2.5" high density foam with Black marine grade vinyl
- Ideal for complete leg conditioning and strengthening of knee, thighs and hamstrings
- Features special split pad that allows for the proper isolation of the muscles
- Can be used for leg extension exercises in the sit-up position and leg curls in the prone position
- 38"H x 24"W x 80"L - 110 lbs.

813102

\$799⁹⁹ EA ★ 



CHIN & DIP STATION

- Constructed of 2" square heavy wall steel tubing
- Multi-grip pull up bar combined with heavy duty dip bar supports with built in step ups
- All welded end caps with tabs for bolting to floor
- 90"H x 26"W x 64"D - 150 lbs.

814800 \$529⁹⁹ EA ★ 



AB EXERCISER, DIP & SIT UP BOARD COMBO

- Constructed of 2" square heavy wall steel tubing
- Use for bent knee raises, straight leg lifts or dips
- Built with 75 degree angle to target abdominal muscles
- Pads are 2.5" high density foam with 40 oz. Black marine grade vinyl
- All welded end caps with tabs for bolting to floor
- 67"H x 25"W x 64"D

814502 Ab/Dip Only \$599⁹⁹ EA ★ 
814602 Combo \$1,099⁹⁹ EA ★ 

BACK & ABDOMINAL EXERCISE BENCH

- Constructed of 2" square heavy wall steel tubing
- Combines hyper extension and Roman chair exercises for the abdomen and lower back
- Adjustable design to accommodate user height
- Pads are 2.5" high density foam with 40 oz. Black marine grade vinyl
- 29.5"H x 36"W x 49.5"D - 93 lbs.

816502 \$549⁹⁹ EA ★ 



ADJUSTABLE SIT UP BOARD

- Constructed of 2" x 3" heavy wall steel tubing
- 6 spring loaded pin positions from 0° - 30° incline
- 16"W x 44"L board is 2.5" high density foam with 40 oz. Black marine grade vinyl
- Ankle and knee supports are fully padded for comfort
- 45"H x 22.5"W x 66.5"L - 63 lbs.

813302 \$449⁹⁹ EA ★ 



HEAVY DUTY LEATHER DIP BELT

- Constructed of heavy-duty leather and steel chain
- Belt is 29"L and chain is 24"L
- Weight plate not included

CHDBXXXX \$93⁹⁹ EA ★



CHIN/DIP/AB STATION

- Constructed of 2" square heavy wall steel tubing
- Multi-grip pull up bar on one side and dip bar and knee raise grips on the other side allows two athletes to exercise simultaneously
- Pads are constructed of 2.5" high-density foam with 40 oz. Black marine grade vinyl
- All welded end caps with tabs for bolting to floor
- 90"H x 26"W x 64"D - 180 lbs.

814702 \$749⁹⁹ EA ★ 

NAUTILUS®

TRUSTED STRENGTH

It's no secret that working out with plates is one of the most effective ways to train and condition, but it's what you do with those weights that makes all the difference. Designed to make working out with plates as effective, rewarding and safe as possible, our Plate Loaded line occupies its own unique place in training and on your facility floor. With industry standard designs like our Leg Press and Hack Squat, we helped set the benchmark for traditional plate loaded machines.



TILT SEAT CALF PLATE LOADED

1459460

\$1,499⁹⁹ EA



HACK SQUAT PLATE LOADED

1459461

\$4,699⁹⁹ EA



GLUTE DRIVE PLATE LOADED

1459462

\$4,499⁹⁹ EA



ANGLED LEG PRESS PLATE LOADED

1459463

\$4,399⁹⁹ EA

NAUTILUS®

TRUSTED STRENGTH

EASY TO USE. EASY ON SPACE.

Welcoming to users of all levels, Instinct® Strength is a full line of intuitive machines with easy adjustments and Lock N Load® weight selection system, offering users a quick and complete workout. Perfectly suited to be a basic strength line or circuit system, Instinct effectively complements more specialized lines. The versatility of Instinct's small footprint also lets you get the most from minimal space, while blending seamlessly with the Instinct Benches & Racks for a cohesive facility look.



FRAME SHOWN IN -60°



INSTINCT LEG PRESS / CALF RAISE

3 Year Limited Warranty

1459441

\$5,449⁹⁹ EA



FRAME SHOWN IN -60°



INSTINCT LEG EXTENSION / SIDE LEG CURL

3 Year Limited Warranty

1459442

\$3,949⁹⁹ EA



FRAME SHOWN IN -60°



INSTINCT INNER / OUTER THIGH

3 Year Limited Warranty

1459443

\$3,949⁹⁹ EA



FRAME SHOWN IN -60°



INSTINCT DUAL ADJUSTABLE PULLEY

3 Year Limited Warranty

1459444

\$5,449⁹⁹ EA



FRAME SHOWN IN -60°



INSTINCT PEC FLY / DELTOID

3 Year Limited Warranty

1459445

\$3,849⁹⁹ EA

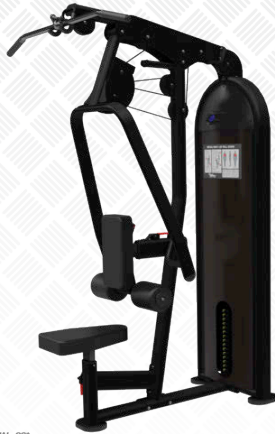

FRAME SHOWN IN -60°



INSTINCT LAT PULLDOWN / LOW ROW

3 Year Limited Warranty

1459447

\$3,849⁹⁹ EA



FRAME SHOWN IN -60°



INSTINCT MULTI-PRESS

3 Year Limited Warranty

1459446

\$3,849⁹⁹ EA



FRAME SHOWN IN -60°



INSTINCT BICEPS / TRICEPS

3 Year Limited Warranty

1459448

\$3,849⁹⁹ EA



FRAME SHOWN IN -60°



INSTINCT ABS / LOW BACK

3 Year Limited Warranty

1459449

\$3,849⁹⁹ EA





FRAME SHOWN IN -60°



INSTINCT LEG EXTENSION, SIDE MOUNT

3 Year Limited Warranty

1459450

\$4,149⁹⁹ EA



FRAME SHOWN IN -60°



INSTINCT SEATED LEG CURL

3 Year Limited Warranty

1459451

\$4,149⁹⁹ EA

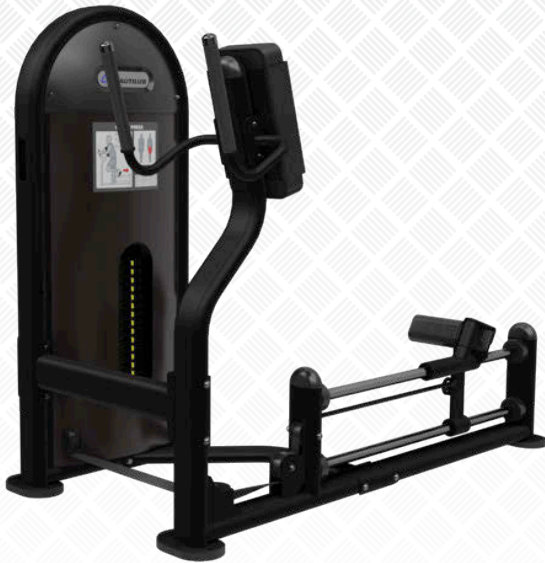

FRAME SHOWN IN -60°



INSTINCT GLUTE MACHINE

3 Year Limited Warranty

1459452

\$4,149⁹⁹ EA



FRAME SHOWN IN -60°



INSTINCT VERTICAL CHEST PRESS

3 Year Limited Warranty

1459453

\$4,149⁹⁹ EA





FRAME SHOWN IN -60°

INSTINCT LAT PULL DOWN

3 Year Limited Warranty

1459454

\$4,149⁹⁹ EA



FRAME SHOWN IN -60°

INSTINCT VERTICAL ROW

3 Year Limited Warranty

1459455

\$4,149⁹⁹ EA



FRAME SHOWN IN -60°

INSTINCT BICEPS CURL

3 Year Limited Warranty

1459457

\$4,149⁹⁹ EA



FRAME SHOWN IN -60°

INSTINCT SHOULDER PRESS

3 Year Limited Warranty

1459456

\$4,149⁹⁹ EA



FRAME SHOWN IN -60°

INSTINCT TRICEPS EXTENSION

3 Year Limited Warranty

1459458

\$4,149⁹⁹ EA



FRAME SHOWN IN -60°

INSTINCT ROTARY TORSO

3 Year Limited Warranty

1459459

\$4,149⁹⁹ EA



Each of our multi-stations have the smallest possible footprint, while combining the most essential elements from our strength lines. Add in great features like swiveling pulleys on the Lat Pull Down, Low Row and Triceps Press and fully adjustable pulleys on the Cable Crossover System, and you have an economical, space-saving equipment solution that doesn't look, feel or train like one.



CROSS-OVER CABLES WITH ADJUSTABLE PULLEYS

1459465

\$8,799⁹⁹ EA



FRAME SHOWN IN -60°



5 STATION WITH ADJUSTABLE PULLEY

1459467

\$16,499⁹⁹ EA



CABLE ATTACHMENTS

- | | | |
|--------------------|------------------------------|-------------------------|
| 1. CHLBPROX | 30" Pro-Style Lat Bar | \$64 ⁹⁹ EA ★ |
| 2. CHLB481X | 48" x 1" Lat Bar | \$79 ⁹⁹ EA ★ |
| 3. CHLBHNDL | Single Chrome Handle | \$23 ⁹⁹ EA ★ |
| 4. CHLB2ORT | Multi Purpose V-Bar | \$41 ⁹⁹ EA ★ |
| 5. CHLBTRXX | Nylon Tricep Rope | \$42 ⁹⁹ EA ★ |
| 6. CHLBVPRS | V Shaped Press Down Bar | \$34 ⁹⁹ EA ★ |
| 7. CHLBMLTI | Revolving Multi-Exercise Bar | \$54 ⁹⁹ EA ★ |
| 8. 1101263 | Nylon Ankle Strap | \$29 ⁹⁹ EA ★ |

Deluxe Cable Attachment Package
(1 each of all of the above)

1382829

\$319⁹⁹ SET ★

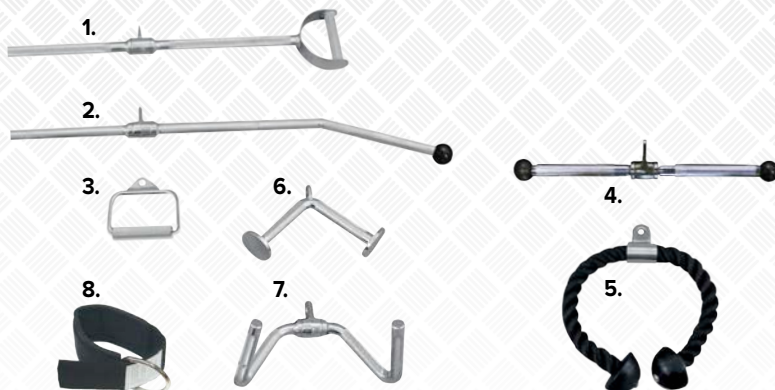

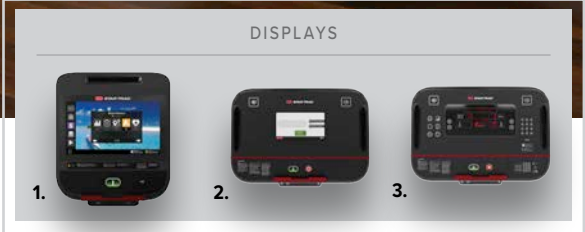
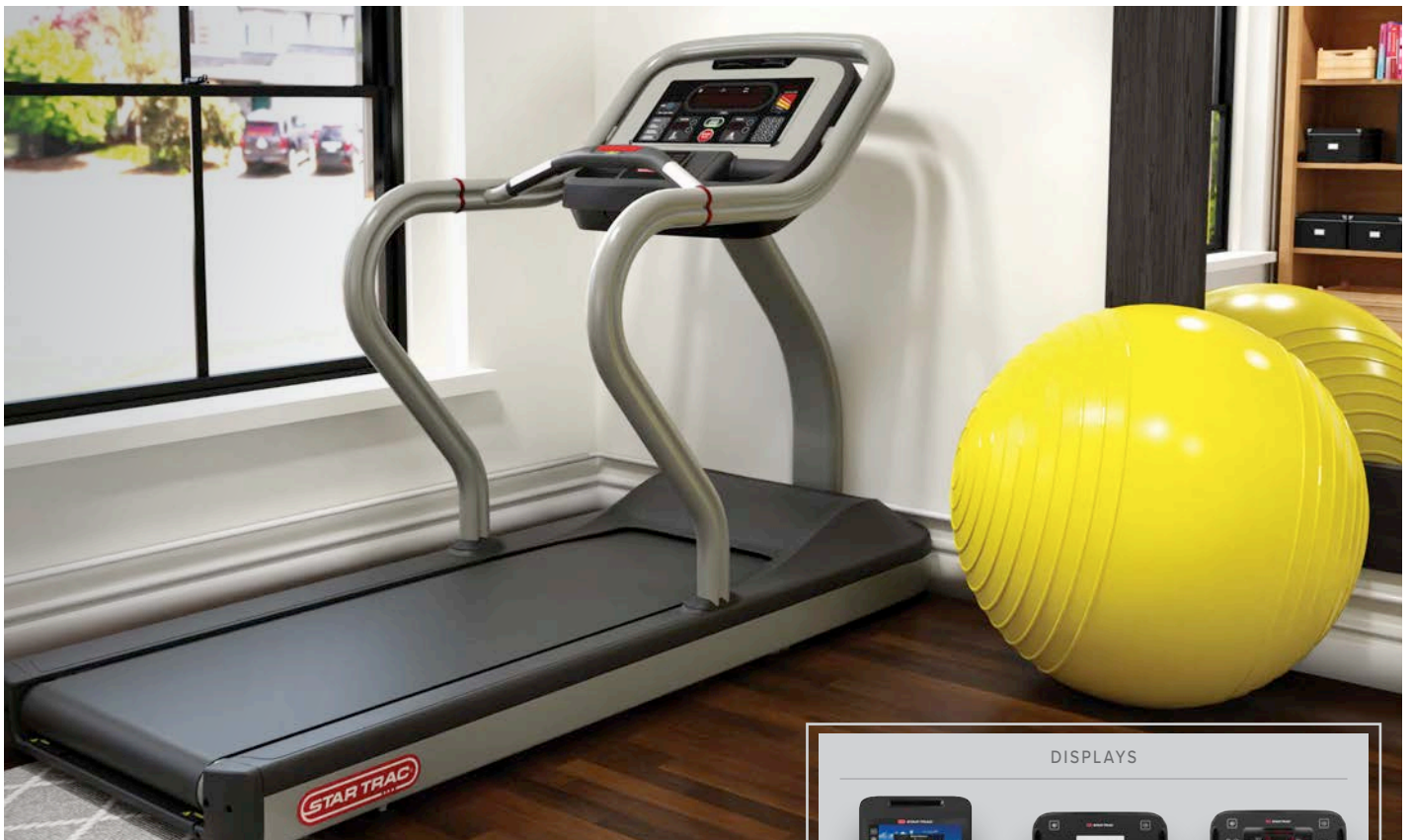

STAR TRAC
MADE TO PERFORM

4 SERIES TREADMILL

- 1. 1459495 15" DISPLAY \$9,199⁹⁹ EA **S&H**
- 2. 1459496 10" DISPLAY \$5,749⁰⁰ EA **S&H**
- 3. 1459497 10" LCD \$4,649⁰⁰ EA **S&H**

MAX USER WEIGHT: 350 lbs.



STAR TRAC
MADE TO PERFORM

S-TRC TREADMILL

- 1459493 MAX USER WEIGHT: 500 lbs. \$8,499⁰⁰ EA **S&H**

S-TRX TREADMILL

- 1459494 MAX USER WEIGHT: 350 lbs. \$8,049⁰⁰ EA **S&H**

STAR TRAC
MADE TO PERFORM

8 SERIES TRX TREADMILL WITH 10" DISPLAY

- 1. 1459487 19" DISPLAY \$14,949⁰⁰ EA **S&H**
- 3. 1459489 LCD \$10,349⁰⁰ EA **S&H**

MAX USER WEIGHT: 500 lbs.



STAR TRAC
MADE TO PERFORM

8 SERIES TR TREADMILL

- 1. 1459490 19" DISPLAY \$14,949⁹⁹ EA **S&H**
- 3. 1459492 10" LCD \$9,949⁰⁰ EA **S&H**

MAX USER WEIGHT: 500 lbs.



• Soft Trac® triple cell cushioning system provides maximum shockabsorption • 15% to 20% max incline 12.5 to 15 mph • Star Trac's popular personal fan for comfort
• USB port provides charging capability for user devices • Contact and telemetry heart rate • Lighter weight aluminum frame for maximum corrosion protection



STAR TRAC
MADE TO PERFORM

- Ergonomic hand grips offer multiple hand positions and heart rate detection
- Articulating foot pads create a very comfortable and natural stride pattern
- Soft Trac® pedals provide ultimate shock-absorbing comfort throughout the entire workout
- 18" (47 cm) stride length
- Star Trac's popular personal fan for comfort
- Integrated USB port provides charging capability for user devices
- User weight capacity 350 lb (159 kg)
- Contact and telemetry heart rate

1. 1459498	15" Display	\$12,599.00 EA	
3. 1459500	10" LCD	\$8,149.00 EA	



STAR TRAC
MADE TO PERFORM

4 SERIES CROSS TRAINER

1. 1459505	15" Display	\$8,049.00 EA	
2. 1459506	10" DISPLAY	\$4,649.00 EA	
3. 1459507	10" LCD	\$3,499.00 EA	

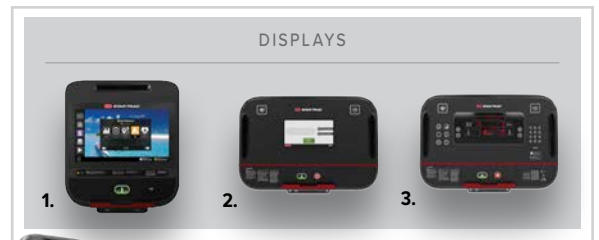

STAR TRAC
MADE TO PERFORM

S-CTX CROSS TRAINER

1459504	\$6,099.00 EA	
---------	---------------	--



STAR TRAC
MADE TO PERFORM

8 SERIES CROSS TRAINER

1. 1459501	15" Display	\$13,299.00 EA	
3. 1459503	10" LCD	\$9,199.00 EA	

• Efficient footprint and approachable, stable platform with minimal stepupheight for easy access from all angles
 • Soft Trac® pedals provide ultimate shock-absorbing comfort throughout the entire workout • 18" TO 20" stride length • Star Trac's popular personal fan for comfort
 • Integrated USB port provides charging capability for user devices • User weight capacity 350 lb • Contact and telemetry heart rate



STAR TRAC
MADE TO PERFORM

8 SERIES RECUMBENT BIKE

1. 1459508	15" Display	\$10,349 ⁰⁰ EA	
3. 1459510	10" LCD	\$5,749 ⁰⁰ EA	



STAR TRAC
MADE TO PERFORM

4 SERIES RECUMBENT BIKE

1. 1459512	15" Display	\$7,499 ⁰⁰ EA	
2. 1459513	10" Touch Display	\$3,499 ⁰⁰ EA	
3. 1459514	10" LCD	\$2,899 ⁰⁰ EA	



STAR TRAC
MADE TO PERFORM

S-RBX RECUMBENT BIKE

- Walk-through design and intuitive wrap-around seat adjust allow users to access and change seat position with ease
- Dual platform pedals with ratcheting straps provide user with option for secure hold or strap-free platform workout
- Armrests alleviate tension in the shoulders and allow for relaxed posture
- Morse Taper bottom bracket and pedal system
- Star Trac's popular personal fan for comfort
- User weight capacity 350 lb (159 kg)
- Contact and telemetry heart rate

1459511	\$4,049 ⁰⁰ EA	
---------	--------------------------	--

DISPLAYS



STAR TRAC
MADE TO PERFORM

8 SERIES UPRIGHT BIKE

1. 1459515	15" Display	\$9,899 ⁰⁰ EA	
3. 1459517	10" LCD	\$5,299 ⁰⁰ EA	



STAR TRAC
MADE TO PERFORM

4 SERIES UPRIGHT BIKE

1. 1459519	15" Display	\$7,249 ⁰⁰ EA	
2. 1459520	10" DISPLAY	\$3,499 ⁰⁰ EA	
3. 1459521	10" LCD	\$2,899 ⁰⁰ EA	



STAR TRAC
MADE TO PERFORM

S-UBX UPRIGHT BIKE

- Dual platform pedals with ratcheting straps provide user with option for secure hold or strap-free platform workout
- Easy-up seat adjust for simple seat position changes
- Morse Taper bottom bracket and pedal system
- Star Trac's popular personal fan for comfort
- User weight capacity 350 lb (159 kg)
- Contact and telemetry heart rate

1459518	\$3,199 ⁰⁰ EA	
---------	--------------------------	--



CT800 LIGHT COMMERCIAL TREADMILL

1364697

\$3,999⁹⁹ EA



Shown with Optional Infotainment Console



SPIRIT FITNESS - CU800 UPRIGHT BIKE

1364700

\$1,899⁹⁹ EA



CE800 ELLIPTICAL

1364698

\$3,499⁹⁹ EA



CAB900 AIR BIKE

- Console outputs: Speed - Watts - RPM - Distance - Time - Odometer - Power
- Ideal for HIIT training and general fitness
- Heavy Duty Steel Frame eliminates side-to-side movement
- Hybrid extra wide seat with multi-adjustment options - up/down - fore/aft
- Industrial powder coating for durability
- Reinforced pedals and crank 3 Year Limited Warranty

3 Year Limited Warranty

1451195

\$1,849⁹⁹ EA



SCHWINN IC CLASSIC

- Indoor bike with flat pedals and cages
- Compatible with Schwinn Triple Link
- User height 4' 11" - 6' 8"
- 48" H x 20" W x 50" L
- User weight capacity 350lbs
- 2 Year Limited Warranty

1456010 \$1,649⁹⁹ EA



SCHWINN AC PERFORMANCE GROUP CYCLE

- Magnetic Resistance Brake for zero drive train maintenance
- Optional 4iiii® crank arm powermeter delivers accurate strain gauge power feedback to help riders train harder and smarter.
- Optional Echelon2 Console provides immediate feedback to help rider train with results
- Morse Taper pedals for increased durability and reliability
- Performance Plus™ handlebars ergonomically designed for reduced hand pressure in performance positions
- Schwinn Fit System enables versatile seat and handlebar adjustments for refined positioning
- Frame Finish - Powder Coated Aluminum
- Seat Slider and handlebar materials - Aluminum

1459470 \$3,099⁹⁹ EA



SCHWINN AC SPORT GROUP CYCLE

- Carbon Blue™ durable toothed drive train provides an Authentic Cycling experience
- Magnetic Resistance Brake for zero drive train maintenance
- Optional 4iiii® crank arm powermeter delivers accurate strain gauge power feedback to help riders train harder and smarter.
- Optional Echelon2 Console provides immediate feedback to help riders train with results
- Morse Taper pedals for increased durability and reliability
- Schwinn Fit System enables versatile seat and handlebar adjustments for refined positioning
- Frame Finish - E-Coated & Powder Coated Steel
- Seat Slider, Handlebars, Hardware Materials - Stainless Steel

1459471 \$2,649⁹⁹ EA



R70 LIGHT COMMERCIAL RECUMBENT BIKE

- For professional light commercial use
- Self-generating power
- 8 built-in programs with 16 levels of resistance
- Feedback includes: time, work level, watts, distance, speed, METs, heart rate and calories
- Display: Matrix + LED
- Torque: 250 Watts
- 45" H x 21" W x 64" L - 165 lbs.
- 400 lbs. maximum user weight 5 Year Limited Warranty

1205909 \$2,449⁹⁹ EA



R70 LIGHT COMMERCIAL UPRIGHT BIKE

- Built for professional light commercial use
- Self-generating power
- 8 built-in programs with 16 levels of resistance
- Feedback includes time, work level, watts, distance, speed, METs, heart rate and calories
- Display: Matrix + LED
- Torque: 250 Watts
- 53" H x 21" W x 42" L - 117 lbs.
- 400 lbs. maximum user weight 5 Year Limited Warranty

1205893 \$2,299⁹⁹ EA



VELOCITY EXERCISE BIKE

- Heavy-duty adjustable spring/shock rider suspension for greater comfort
- Comfort gel saddle with mid-section cutaway for reduced seating pressure
- Ultra-smooth, quiet Poly-V Drive Belt system needs no-maintenance & can be tensioned without removing drive cover
- 47 lb. stainless flywheel in pillow-block bearing for super-fluid spinning
- Nonskid rubber feet can be adjusted for uneven surfaces
- Ergonomic triathlon-style handle bar offers multiple hand positions
- 55" H x 25" W x 44" L - 129 lbs.
- 300 lbs. maximum user weight 1 Year Limited Warranty

1205855 \$1,199⁹⁹ EA



MOMENTUM EXERCISE BIKE

- Professional exercise bike designed for intensive use in institutions and gymnasiums
- 44 lb. flywheel weight
- Sleek look with protective flywheel cover
- Safe pinlocking seat
- Includes transport wheels for easy portability
- 55" H x 20" W x 43" L - 120 lbs.
- 275 lbs. maximum user weight 1 Year Limited Warranty

1272246 \$1,049⁹⁹ EA





STAIRMASTER 10 SERIES

- Available with 3 OpenHub™ console options
- OverDrive Training Mode simulates carrying or pushing a load up stairs for an all-new level of HIIT workout
- Widest, deepest step in the industry and lowest step up height
- Redesigned handrail system supports a variety of workout positions including push/carry in new OverDrive Training Mode and optimal entry/exit
- Service panel removes with 4 fasteners, allows easy access to drive train and electronics
- Hand rail mounted stop button, level controls and contact heart rate
- Electronically controlled alternator, brake, and drive chain precisely control the stair speed, allowing a wide range of users to exercise smoothly within their comfort zones
- Revolving staircase with eight steps. Step surface: 8" (20cm) high, 9" (23 cm) deep and 22" (56 cm) wide.
- Step rate: 24-162 steps per minute
- User weight capacity 350 lb (159 kg)

1459473	15" Display	\$18,349 ⁰⁰ EA	
1459474	10" DISPLAY	\$14,899 ⁰⁰ EA	
1459475	10" LCD	\$13,299 ⁰⁰ EA	



STAIRMASTER 8 SERIES GAUNTLET

- Choose from LCD, 10" or 15" OpenHub display options
- Includes the Landmark Challenge Program which allows users to climb well-known landmarks from around the world like the Eiffel Tower, Statue of Liberty and Taj Mahal.
- Bluetooth connectivity for user workout data tracking
- USB charging port
- Recommended ceiling height: 10ft

1465108	15" Display	\$15,649 ⁹⁹ EA	
1465109	10" Display	\$12,599 ⁹⁹ EA	
1465110	LCD Display	\$10,199 ⁹⁹ EA	



STAIRMASTER HIIT ROWER

- StairMaster HIIT console
- Isokinetic fan resistance offers unlimited workout options
- Fan dampening system allows for increased or decreased workloads at a given stroke rate
- Water bottle and accessory holder located under foot plates for safe storage
- Easy storage while not in use by disconnecting at center point
- User weight 500 lb as tested by CORE / 350 lb as tested per EN 20957-7
- Power two C cell batteries or an optional external power supply can be ordered
- Drive Train Nickel plated steel chain
- Construction Aluminum and Steel
- Electrostatic Powder Coating for long lasting durability

1459485		\$2,099 ⁰⁰ EA	
---------	--	--------------------------	--



STAIRMASTER 8 SERIES FREECLIMBER

- Available with 3 OpenHub™ console options
- 10 programs - Quick Start, Manual, Fat Burner, Calorie Burner, Speed Intervals, Custom Intervals, Random Intervals, Heart Rate Intervals, Calorie Goal, Heart Rate Zone Trainer
- Electronically controlled alternator with chain drive precisely controls the pedal descent allowing a wide range of users to exercise smoothly within their comfort zones
- Patented independent pedal geometry with four-bar linkage keeps pedals level ensuring a comfortable, biomechanically correct movement
- Step range 1" to 14" (2.5 cm to 36 cm)
- Step rate: 26-174 steps per minute

1459479	15" Display	\$11,449 ⁰⁰ EA	
1459480	10" DISPLAY	\$9,199 ⁰⁰ EA	
1459481	10" LCD	\$7,149 ⁰⁰ EA	



STAIRMASTER HIIT BIKE

- Dual-action wind resistance provides a total body workout
- HIIT console with easy to read backlit display, Bluetooth & ANT+ connectivity, and programmable time, distance, calories, time interval, and calorie interval programs
- Robust, heavy gauge welded steel construction
- The StairMaster HIIT Bike™ was given a warm welcome at the CrossFit Games where it put the toughest among us to the test
- Backed by a full commercial warranty
- User compatible size range typically 4'11" to 6'8" (150 to 203 cm) tall
- User weight capacity 350 lb (159 kg)

1459483		\$2,999 ⁰⁰ EA	
---------	--	--------------------------	--



STAIRMASTER HIITMILL X

- Self-powered walking, running and pushing
- Magnetic resistance brake
- Multi-grip hand positioning
- Portable design
- Water bottle and phone holder
- Accessory attachment points (straps and tubing not included)
- Farmer's Carry lift arms
- 3mm cushioned turf belt compatible with plastic field cleats
- HIIT console with easy to read backlit display, Bluetooth & ANT+ connectivity, and programmable time, distance, calories, time interval, and calorie interval programs

1459482

\$6,899⁰⁰ EA



STAIRMASTER HIIT UBE

- Adjustable tower accommodates a wide variety of workouts and usersizes
- Integrated bench for seated workouts can be removed to accommodate standing or wheelchair workouts
- Adjustable cranks for varied range of motion and bilateral or unilateral motions
- HIIT console with easy to read backlit display, Bluetooth & ANT+ connectivity, and programmable time, distance, calories, time interval, and calorie interval programs
- Wheelchair accessible ramp option allows wheelchair access and meets ADA criteria. The removable ramp's unique mounting system adds only 22" (56 cm) to the total length of the machine
- User weight capacity 350 lb (159 kg)

1459484

\$4,499⁰⁰ EA



TRUEFORM TRAINER

- Trainer curve is so shallow, users feel safe and in control of their speed, whether walking, jogging, or running.
- LCD is compatible with Polar heart rate monitor T31
- Dimensions: 64" x 36" x 63"
- Unit Weight: 340lb
- Max Weight: 500lb

1460523

\$4,995⁹⁹ EA



TRUEFORM RUNNER

- The TrueForm Runner is the most natural running treadmill ever made and proven to dramatically improve run form by reducing impact stress, reducing asymmetry, increasing efficiency, and reducing the risk of injury.
- Dimensions: 64" x 36" x 63"
- Unit Weight: 340lb
- Max Weight: 500lb

1460524

\$7,999⁹⁹ EA



1" IMPACT PRO TILE

Impact Pro Tiles
 Colors: Black or 10% Gray
 Dimensions: 24" x 24" x 1"

1469731	24"x24" Black	\$48 ⁹⁹ EA
1469732	24"x24" Gray	\$49 ⁹⁹ EA

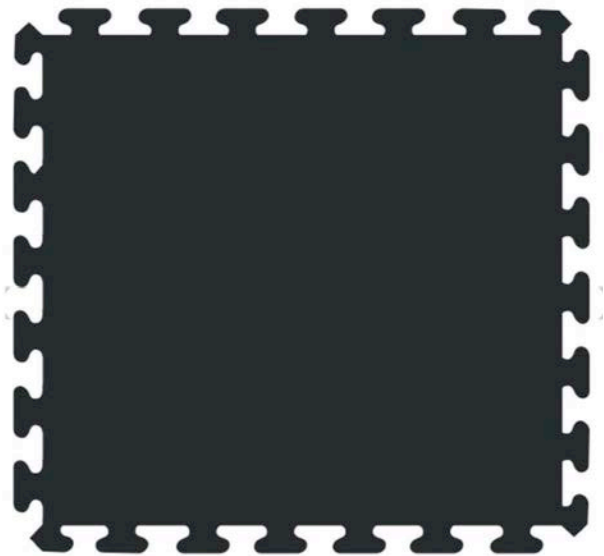

3/8" INTERLOCKING TILES

Impact-Lok 3/8" center tiles
 Colors - Black or 10% Gray
 Dimensions - 24" x 24"

1469726	24"x24" Black	\$19 ⁹⁹ EA
1469727	24"x24" Gray	\$20 ⁹⁹ EA



1/2" INTERLOCKING TILES

Impact-Lok 1/2" center tiles
 Colors - Black or 10% Gray
 Dimensions - 22.5" x 22.5"

1469728	22.5" x 22.5" Black	\$34 ⁹⁹ EA
1469729	22.5" x 22.5" Gray	\$38 ⁹⁹ EA



1/2" IMPACT MAT

Impact Mat 1/2"
 Color - Black
 Dimensions: 4' x 6'

1469730	4'x6' Black	\$169 ⁹⁹ EA
---------	-------------	------------------------



IMPACT TRACK RUNWAY

Impact Track Rollout Runway
 Color - Black
 Dimensions: 4'W x 3/8"H
 Sold per Sq Ft

1469733	4'x3/8" Black	\$3 ⁴⁹ SQ.FT
---------	---------------	-------------------------



FLOOR CLEANER

1469734	1 Gallon	\$88 ⁹⁹ EA
---------	----------	-----------------------

REACTOR
CHAMPION BARBELL

WORKOUT BAR STORAGE RACK

- 16-gauge powder coated rectangular tube and cold rolled steel construction
- Some assembly required
- Holds up to 35 bars depending on size

1205572 41.5"H x 24.25"W x 20"D \$329⁹⁹ EA ★



REACTOR
CHAMPION BARBELL

WORK OUT BAR

- 48" long weighted steel bars
- Rubber coated foam covers bars for easy grip while exercising
- Great for incorporating into squats, lunges, dead lifts, bicep curls and dead rows
- Color coded sizes for easy identification

1266467	4 lb.	\$38 ⁹⁹ EA ★
1266474	6 lb.	\$45 ⁹⁹ EA ★
1266481	9 lb.	\$51 ⁹⁹ EA ★
1266498	12 lb.	\$59 ⁹⁹ EA ★
1266504	15 lb.	\$74 ⁹⁹ EA ★
1266511	18 lb.	\$89 ⁹⁹ EA ★



REACTOR
CHAMPION BARBELL

VERTICAL MEDICINE BALL RACK

- Heavy duty square steel construction with durable black powder coated finish
- Holds 5 balls

1033267 66"H x 16"W x 25"D \$179⁹⁹ EA ★



REACTOR
CHAMPION BARBELL

2-SIDED MEDICINE BALL RACK

- Heavy duty square steel construction with durable black powder coated finish
- Holds 8 balls

1033250 58"H x 24"W x 30"D \$219⁹⁹ EA ★ **SAH**



REACTOR
CHAMPION BARBELL

ROLLING MEDICINE BALL RACK

- 6 tiers, holds 24 medicine balls
- Holds balls up to 16" in diameter
- Silver powder coated finish
- 4 heavy-duty lockable swivel casters

1367628 72"H x 29"W x 29"D \$679⁹⁹ EA ★ **SAH**

Mueller

WHIZZER®

- Multipurpose concentrate kills HIV-1 (AIDS virus), MRSA, Hepatitis B & C, and other viruses. Kills strep, staph and fungus germs on contact.
- Cleaner, fungicide, mildewstat, virucide and deodorizer - all in one. Comes complete with 2 FREE Pint spray bottles.
- Economical. One ounce of concentrate mixed with water makes a gallon of full-strength disinfectant. 128 dilutions per gallon.
- Fast. Apply directly to mats, floors, walls, training tables, locker rooms, or personal items. Just wipe dry.

30 Day Limited Warranty

MU230201 1 Gallon + 2 FREE Pint Spray Bottles \$119⁹⁹ CASE



REACTOR
CHAMPION BARBELL

AEROBAR

- Rather than lifting static weight, user resists the force of moving weight
- Provides up to 250 muscle contractions per minute
- Great for general fitness, sport-specific training, rehab, strength and aerobic conditioning
- Heavy-duty composite material with comfort grip handle and padded rubber safety tips

1369601 48" L \$49⁹⁹ EA ★

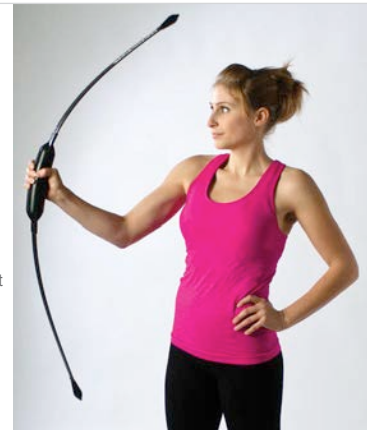

REACTOR

by CHAMPION BARBELL™



VINYL COATED KETTLEBELLS

• Vinyl coated to protect flooring and reduce noise

1266818	10 lb. - Light Blue	\$44 ⁹⁹ EA ★
1266825	15 lb. - Red	\$64 ⁹⁹ EA ★
1267280	20 lb. - Yellow	\$84 ⁸⁸ EA ★
1267297	25 lb. - Royal	\$109 ⁹⁹ EA ★
1267303	30 lb. - Orange	\$129 ⁹⁹ EA ★
1267310	35 lb. - Kelly Green	\$149 ⁹⁹ EA ★
1267327	40 lb. - Purple	\$169 ⁹⁹ EA ★
1267334	45 lb. - Black	\$199 ⁹⁹ EA ★

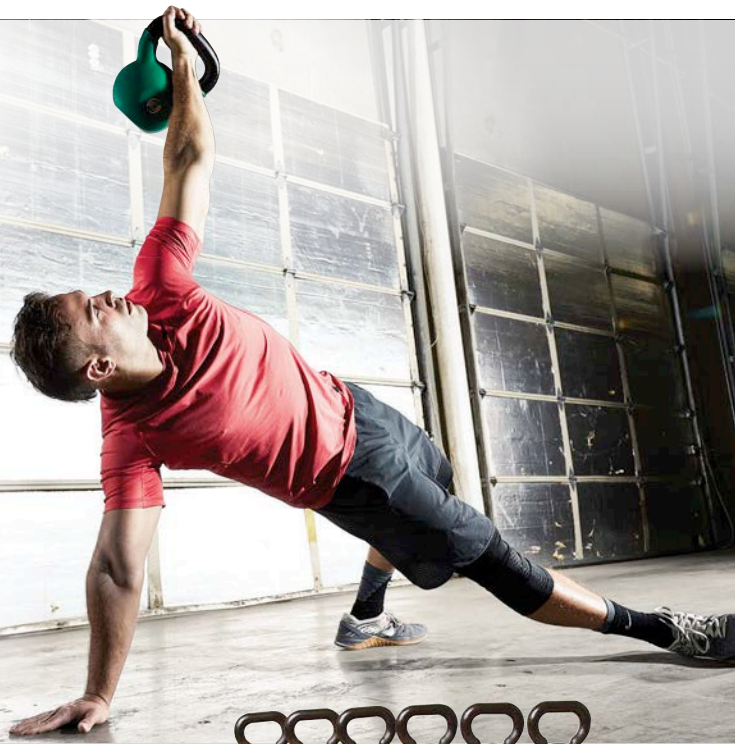

RUBBER KETTLEBELLS

- All sizes (weights) are 8" diameter
- Combine strength training & muscle coordination training
- Develop muscle tone, strength and flexibility while promoting fat loss
- Effective for both upper and lower body work-outs

1361735	6 lb. - Light Blue	\$89 ⁹⁹ EA ★	1361780	16 lb. - Green	\$139 ⁹⁹ EA ★
1361742	8 lb. - Red	\$89 ⁹⁹ EA ★	1361797	18 lb. - Purple	\$144 ⁹⁹ EA ★
1361759	10 lb. - Yellow	\$99 ⁹⁹ EA ★	1361803	20 lb. - Light Blue	\$169 ⁹⁹ EA ★
1361766	12 lb. - Royal Blue	\$109 ⁹⁹ EA ★	1361810	25 lb. - Red	\$179 ⁹⁹ EA ★
1361773	14 lb. - Orange	\$129 ⁹⁹ EA ★	1361827	30 lb. - Yellow	\$199 ⁹⁹ EA ★



KETTLEBELL STORAGE RACK

- Holds any size kettlebell on 3 shelves
- Back lip on each shelf prevents fall through
- Heavy-duty all steel construction

1342611 26"H x 45"W x 23"D \$314⁹⁹ EA ★



KETTLEBELLS

- Combine strength training, muscle coordination and aerobic exercise all in one product
- Helps develop muscle tone, strength and flexibility while promoting fat loss
- Can be used for both upper and lower body workouts

1266733	10 lb.	\$39 ⁹⁹ EA ★	1266801	45 lb.	\$159 ⁹⁹ EA ★
1266740	15 lb.	\$54 ⁹⁹ EA ★	1455199	53 lb.	\$185 ⁹⁹ EA ★
1266757	20 lb.	\$79 ⁹⁹ EA ★	1455200	62 lb.	\$189 ⁹⁹ EA ★
1266764	25 lb.	\$94 ⁹⁹ EA ★	1455201	71 lb.	\$202 ⁹⁹ EA ★
1266771	30 lb.	\$119 ⁹⁹ EA ★	1455202	80 lb.	\$219 ⁹⁹ EA ★
1266788	35 lb.	\$134 ⁹⁹ EA ★	1455203	88 lb.	\$227 ⁹⁹ EA ★
1266795	40 lb.	\$149 ⁹⁹ EA ★	1455204	97 lb.	\$269 ⁹⁹ EA ★



HANDHELD FITNESS BALLS

- Soft, weighted vinyl balls fit comfortably into the palm of the hand
- Incorporate into matwork routines to increase intensity and bring awareness to shoulder girdle stability or target desired muscle groups

1266351	1 lb. - Green	\$16 ⁹⁹ EA ★
1266368	2 lb. - Red	\$18 ⁹⁹ EA ★
1266375	3 lb. - Yellow	\$20 ⁹⁹ EA ★
1266382	4 lbs. - Royal	\$22 ⁹⁹ EA ★

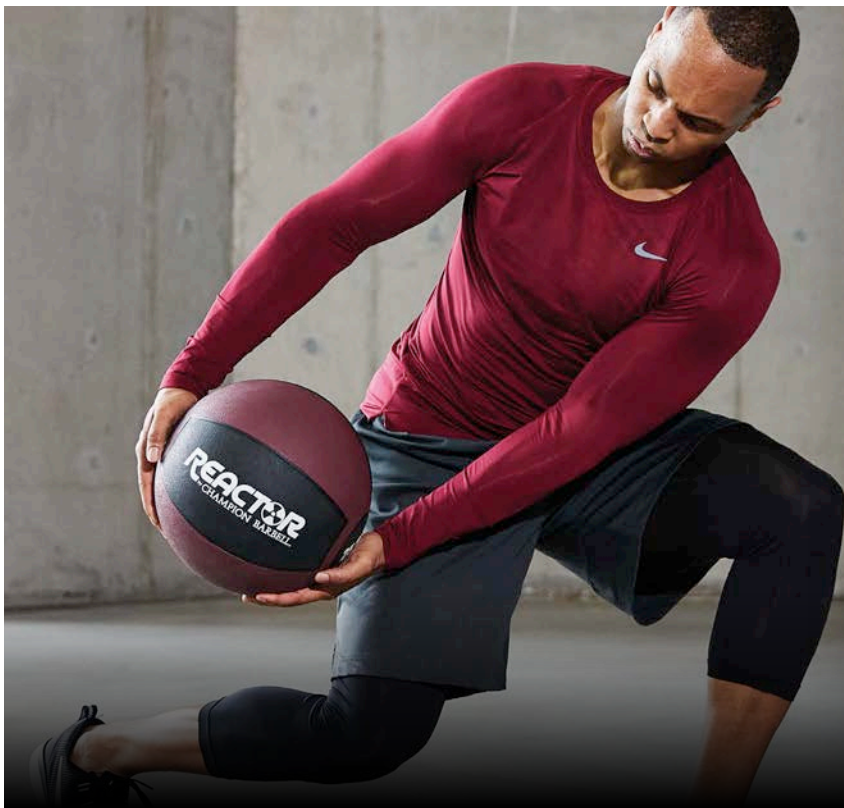

REACTOR

by CHAMPION BARBELL

RUBBER MEDICINE BALLS

- Durable textured rubber cover makes them easy to grip
- Air filled with limited bounce
- Color coded sizes for easy identification
- Not designed for use in slamming exercises

1266283	2.2 lb. - Light Blue	\$49.99 EA ★
1266290	4.4 lb. - Red	\$64.99 EA ★
1266306	6.6 lb. - Yellow	\$79.99 EA ★
1266313	8.8 lb. - Royal	\$94.99 EA ★
1266320	11 lb. - Orange	\$109.99 EA ★
1266337	13.2 lb. - Green	\$124.99 EA ★
1266344	15.4 lb. - Purple	\$139.99 EA ★
1364666	20 lb. - Gold	\$229.99 EA ★
1364664	25 lb. - Maroon	\$239.99 EA ★
1364665	30 lb. - Dark Green	\$259.99 EA ★



REACTOR

by CHAMPION BARBELL

MEDICINE BALLS

- Traditional design, sizes and weights
- Synthetic leather cover
- Color coded sizes for easy identification
- Not designed for use in slamming exercises

1266238	4-6 lb. - Red	\$34.99 EA ★
1266245	6-7 lb. - Yellow	\$44.99 EA ★
1266252	9-10 lb. - Blue	\$59.99 EA ★
1266269	11-12 lb. - Orange	\$69.99 EA ★
1266276	15-16 lb. - Green	\$79.99 EA ★
1377213	17-18 lb. - Purple	\$99.99 EA ★
1377214	19-20 lb. - Yellow	\$109.99 EA ★



14" WALL BALL

- Durable sewn polyester exterior withstands impacts
- Soft interior padding for easy grip
- Shell construction provides stable base
- 14" diameter

1455185	10 lb.	\$93.99 EA
1455186	16 lb.	\$109.99 EA
1455187	20 lb.	\$122.99 EA

REACTOR

by CHAMPION BARBELL

SMASH BALLS

- Specifically designed to smash and slam without bouncing or rolling
- Durable textured cover to withstand the most demanding slam workouts
- Latex free PVC cover will not split or crack
- Sand filled center shifts with exercise movements to engage core and stabilizer muscles
- Ball diameter varies from 7" to 10" depending on weight

1375501	6 lb. - 7" Dia.	\$49.99 EA ★
1375502	8 lb. - 7" Dia.	\$59.99 EA ★
1375503	10 lb. - 7" Dia.	\$69.99 EA ★
1375504	15 lb. - 9" Dia.	\$84.99 EA ★
1375505	20 lb. - 9" Dia.	\$99.99 EA ★
1375506	25 lb. - 9" Dia.	\$109.99 EA ★
1375507	30 lb. - 10" Dia.	\$119.99 EA ★
1375508	35 lb. - 10" Dia.	\$129.99 EA ★



**BEST
SELLER**



AB WHEEL

- Tones and strengthens the abdominals
- Double wheel for added stability

MSABWHLX \$26⁹⁹ EA ★



LIFELINE POWER WHEEL

- Place hands shoulder width apart or Feet in stirrups to more exercise options
- Patented Heavy Duty construction -13" Diameter Wheel & 22" Wide Handle allow
- Adjustable and secure foot straps and stirrups for quick on/off
- Comfortable, Soft foam grip limits hand fatigue

60 Day Limited Warranty

1455217 \$59⁹⁹ EA



**REACTOR
CHAMPION BARBELL**
AB STRAPS

- Attaches to any pull up bar
- Ideal for training the hard to hit lower abdominals
- Now featuring heavy-duty steel carbineers

1277463 \$40⁹⁹ EA

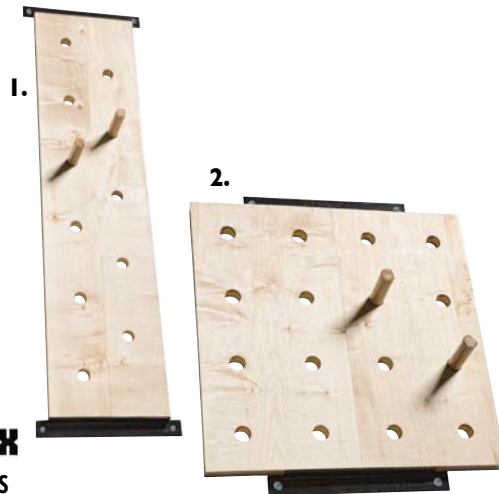

**POWERMAX
PEGBOARD CLIMBERS**

- Turn empty walls into active training and testing areas
- 1. • Pegboards provide challenge while increasing arm and shoulder strength
- 2. • Manufactured of 1 1/2" thick hardwood with clear coat varnish finish
- Comes complete with two hand-grip pegs
- Wall mounting brackets and replacement pegs sold separately

1375518	60"H x 15"W	\$849 ⁹⁹ EA
1375519	30"H x 30"W	\$849 ⁹⁹ EA
1375520	Mounting Bracket	\$279 ⁹⁹ PR
1375521	Replacement Pegs	\$49 ⁹⁹ PR



**REACTOR
CHAMPION BARBELL**
AB MAT

- Abdominal exerciser and core trainer supports lower back for proper positioning
- Safe, comfortable design to help prevent injury
- Designed to take anywhere

1369609 \$39⁹⁹ EA

WALL MOUNTED ADJUSTABLE PULL UP BAR

- Powder coated solid steel bar and frame is adjustable in 6" increments within a 30" range
- Frame attaches to steel stringers and is removable for storage
- Bar is 40"L x 1" O.D. - 29 lbs.
- Stringers are each 54" long with mounting holes 24" apart; mount 37 1/2" center to center
- Mounting hardware not included

1137286 \$299⁹⁹ EA ★

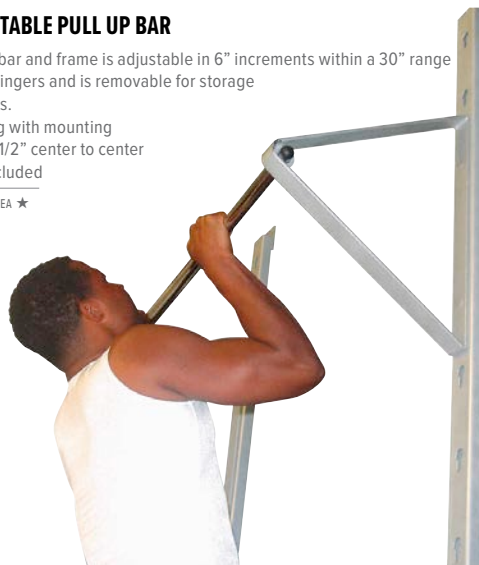

NEW!

PRO KNIT HIP BAND

- Comfortable fabric that stays in place during training and won't pinch or pull skin
- Can be used to add resistance during warmup and stretching
- Strong, durable fabric available in light, medium and heavy resistances
- Portable size, machine washable and easy to clean
- Bands measure 4'x13'



1461067	Heavy	\$19⁹⁹ EA
----------------	-------	-----------------------------

NEW!

PRO KNIT MINI BAND

- Comfortable fabric that stays in place during training and won't pinch or pull skin
- Can be used to add resistance during warmup and stretching
- Strong, durable fabric available in medium and heavy resistances
- Portable size, machine washable and easy to clean
- Bands measure 2.5"x13"



1461068	Heavy	\$14⁹⁹ EA
1461069	Medium	\$14⁹⁹ EA



REACTOR
THE CHAMPION MARKER

BODY LOOP BANDS

- Closed loop design fits around the upper and lower legs
- 12" long loops are ideal for short, limited movements while the 22" long loops are suited for more dynamic movements with a greater range of motion

1301700	12" - Light - Orange	\$8⁹⁹ EA ★
1301717	12" - Light/Medium - Red	\$8⁹⁹ EA ★
1301724	12" - Medium - Blue	\$9⁹⁹ EA ★
1301731	12" - Heavy - Green	\$9⁹⁹ EA ★
1301755	22" - Light - Orange	\$12⁹⁹ EA ★
1301762	22" - Light/Medium - Red	\$13⁹⁹ EA ★
1301779	22" - Medium - Blue	\$14⁹⁹ EA ★
1301786	22" - Heavy - Green	\$17⁹⁹ EA ★



STROOPS

SLASTIX® TONER

- Slastix technology incorporates a Safety Sleeve that encloses latex tubing that protects it from wear, nicks and cuts
- Sleeve also provides safety stretch limitations during resistance training
- 4' long with comfortable handles on each end

GX52652	Very Light - Purple	\$22⁹⁹ EA
GL02615	Light - Yellow	\$25⁹⁹ EA
GL02616	Medium - Red	\$27⁹⁹ EA
GL02614	Heavy - Blue	\$29⁹⁹ EA
GX52651	Very Heavy - Green	\$31⁹⁹ EA



TRAINER CABLES

- Removable cable per handle for variable resistance
- Flexible, rotating handle allows for full range of motion and ergonomic rotation
- 10-50 lbs. peak resistance on each side

60 Day Limited Warranty

1455193	20 lbs - Purple	\$32⁹⁹ EA
1455194	30 lbs - Pink	\$29⁹⁹ EA
1455195	50 lbs - Orange	\$31⁹⁹ EA
1455196	70 lbs - Yellow	\$36⁹⁹ EA
1455197	90 lbs - Blue	\$39⁹⁹ EA
1455198	100 lbs - Black	\$41⁹⁹ EA

CAN DO

EXERCISE TUBES WITH HANDLES

- Includes comfortable foam covered plastic handles
- Perform lower body, upper body and core conditioning exercises with our multi-use resistance tubes
- Isolate muscles or use as a full range of motion exerciser
- Choose from 5 levels of resistance and all are 48" long

1249798	X-Light - Yellow	\$12⁹⁹ EA
1249804	Light - Red	\$13⁹⁹ EA
1249811	Medium - Green	\$14⁹⁹ EA
1249828	Heavy - Blue	\$16⁹⁹ EA
1342574	X-Heavy - Black	\$16⁹⁹ EA





REACTOR
CHAMPION BARBELL

ANTI-BURST FITNESS BALLS

- Target abs, back and glutes to strengthen and tone
- Advanced users position the ball for upper and lower body workouts
- Ideal for stretching and warm-up exercises
- Burst resistant up to 600 lbs.

1335910	45cm - Purple	\$49⁹⁹ EA ★
1335927	55cm - Green	\$52⁹⁹ EA ★
1335934	65cm - Yellow	\$59⁹⁹ EA ★
1337211	75cm - Red	\$64⁹⁹ EA ★

REACTOR
CHAMPION BARBELL

CORE STABILITY BALLS

- Improve and maintain balance, coordination, posture and flexibility
- Strengthens hard-to-reach muscles often overlooked in normal training
- Use to perform a variety of balance, core, strength, flexibility and rehabilitation exercises

1335873	45cm - Purple	\$39⁹⁹ EA ★
1335880	55cm - Green	\$42⁹⁹ EA ★
1335897	65cm - Yellow	\$49⁹⁹ EA ★
1335903	75cm - Red	\$54⁹⁹ EA ★

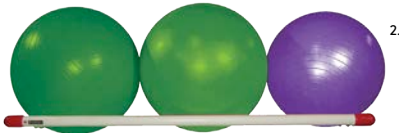

STABILITY BALL STORAGE

- Stores and safely transports stability balls with a diameter of 16" or larger, plus jump ropes, exercise bands and resistance tubes
- Lightweight PVC, yet strong, durable and maintenance free
- Roll lock casters secure cart in place with the push of a lever
- Easily passes through a standard doorway
- Wall mounted stability ball rack (mounting hardware not included)
- Conveniently holds 3 medium or 2 large fitness balls



1. 1257557	Cart - 67"H x 67"W x 19"D	\$679⁹⁹ EA
2. 1369556	Wall Rack - 55"W x 18"D	\$129⁹⁹ EA



REACTOR
CHAMPION BARBELL

STABILITY BALL WITH FEET

- Burst-resistant ball with the addition of small peg feet
- Provides all of the ergonomic seating benefits of a traditional stability ball, but stays put when not in use
- Can also be used on its side like a regular stability ball
- 600 lb. weight limit

1333909	45cm - Light Blue	\$36⁹⁹ EA ★
1333916	55cm - Red	\$38⁹⁹ EA ★
1333923	65cm - Yellow	\$45⁹⁹ EA ★

**BEST
SELLER**



ECONOMY ELECTRIC INFLATOR

- High impact plastic desktop inflator
- 120v and .9 amps
- 100 psi gauge
- Coiled inflation tube that will stretch to 30"
- Comes with needle and other inflation valves

MSECOLEY **\$149⁹⁹** EA ★



CANDO
13" BALANCE DISK

- Improves coordination, stability, posture and motor skills
- Resembles the sensation of the stability ball and works the core and stabilizer muscles in a more compact environment
- Place them in a chair to help support and challenge the spinal muscles while enhancing posture
- Use two discs for double arm and leg activities such as push ups and squats
- Uses standard needle inflation (pump included)
- Supports up to 350 lbs.

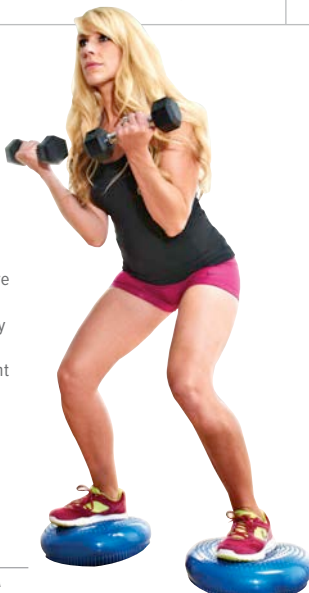

1377189 Specify Color **\$34⁹⁹** EA

CANDO

24" BALANCE DISK

- Promotes core stability and provides many of the same benefits of a stability ball while performing lower back and abdominal exercises
- Support and challenge the spinal muscles while enhancing posture
- The tactile surface has been shown to enhance calmness and concentration
- Perform exercises while sitting, kneeling, or lying on top of the disc for dynamic stabilization training
- Inflation requires a standard foot or hand air pump (not included)
- Supports up to 450 lbs.

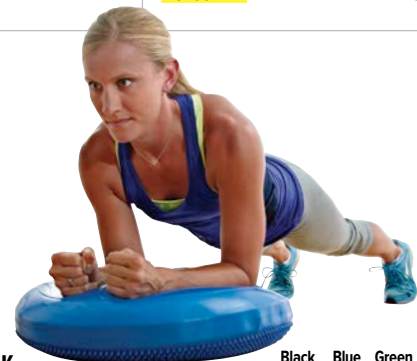

1377194 Specify Color **\$68⁹⁹** EA



DUAL-DENSITY WORKOUT MAT

- Extra-tough Polyethylene mat for yoga, pilates, stretching and exercise
- Dual density foam is strong on the inside and soft on the outside
- Cut out carry handle

1271027 48"L x 24"W x 1" \$69⁹⁹ EA ★



HANGING WORKOUT MATS

- Reinforced grommets allow mats to hang for storage

1277159 48"L x 20.5"W x 3/8" - Red \$59⁹⁹ EA ★
1277197 72"L x 24"W x 5/8" - Blue \$89⁹⁹ EA ★



GAMECRAFT® ACTIVITY MAT

- Durable but soft mat with a patented self-sealing foam will not tear, peel or split under normal use
- Mat can be stored flat or rolled up
- Water resistant for easy maintenance and comes with built-in handles

7137XXXX 48"L x 24"W x 3/8" \$39⁹⁹ EA ★

HANGING MAT RACK

- Height and width adjustments allow this rack to work with different length and width hanging mats
- Constructed of 1.5" and 1.25" square steel tubing with Silver powder coated finish
- Holds up to 50 - 48" or 32 - 72" mats or a combination of both
- Equipped with 4 non-marring polyurethane swivel casters; 2 locking

1378641 Cart Only 74"H x 28"W x 36"L - 39 lbs. \$299⁹⁹ EA ★
1388485 Cart + 24 Mats (48"L x 20.5"W x 3/8") \$1,199⁹⁹ PACK ★
1388486 Cart + 24 Mats (72"L x 24"W x 5/8") \$1,999⁹⁹ PACK ★

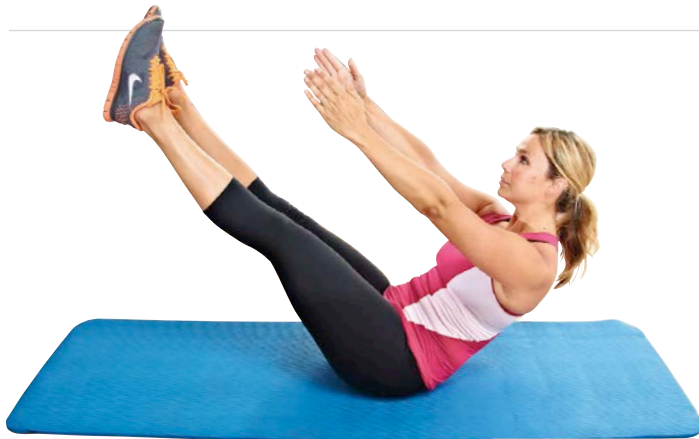

PACMAT 100

- Composed of Nitrile™ rubber
- Offers maximum comfort and impact resistance
- The patented cellular foam will not crack, peel or tear under normal use
- Water resistant for easy maintenance

PACMAT 75"L x 24"W x 7/16" \$54⁹⁹ EA ★



2' X 6' FOLDING



ECONOMY EXERCISE MATS

- Resilient foam covered with a durable vinyl
- Handles are at each end for easy carrying

GCMAT261 72"L x 24"W x 1" - Folding \$89⁹⁹ EA ★
GCMAT241 48"L x 24"W x 1" - Non-Folding \$79⁹⁹ EA ★



BEST SELLER



YOGA MAT

- Lightweight, durable sticky mat
- Cushioned non-slip surface
- Hand washable, air dry

1240146	68" L x 24" W x 1/8"	\$39⁹⁹ EA ★
----------------	----------------------	-------------------------------



CAN DO

BALANCE PAD

- The CanDo Balance Pad combines both exercise and coordination skills
- Widely used for rehabilitation and sports conditioning
- Super soft, closed cell foam pad forces active recruitment of the foot's muscular system, increasing strength, stamina and mobility
- Impervious to water, easy to clean and long-lasting

1388425	20" L x 16" W x 2 1/2" D	\$69⁹⁹ EA
----------------	--------------------------	-----------------------------



YOGA BLOCKS

- For additional support during transitions and poses
- Available in 3" or 4" thickness
- Blue only

1301946	3" Thick	\$29⁹⁹ EA
1301953	4" Thick	\$34⁹⁹ EA



GAME CRAFT

RIBBED MULTI-PURPOSE MATS

- Closed cell foam is great for repelling water or stains
- Hygienic, easy to clean and easily rolled for storage
- Non-slip, hard-wearing and long lasting
- Warm and comfortable to the touch

1022391	56" L x 23" W x 3/4" - Red	\$69⁹⁹ EA ★
1013047	72" L x 39" W x 5/8" - Blue	\$99⁹⁹ EA ★



AEROBIC MAT

- The ideal stretching and exercise mat, durable yet soft
- Use for aerobics or under your yoga mat
- Beveled edges have sealed borders on all 4 sides
- Can be rolled for storage
- Black pebble finish

1235005	60" L x 24" W x 3/8"	\$69⁹⁹ EA ★
----------------	----------------------	-------------------------------



YOGA STRAPS

- Assists with achieving the proper pose or position
- Excellent tool for increasing flexibility
- Buckle allows you to adjust the strap length
- Available in 6' or 8' lengths

1301922	6' Long	\$24⁹⁹ EA
1301939	8' Long	\$24⁹⁹ EA

REACTOR
CHAMPION BARBELL

BARREL ROLLER

- This deep tissue roller has a molded plastic core for shape retention and is covered in a multi-textured thick rubber-foam
- The textured surface is great for both myofascial release and knotted-muscle trigger-point relief
- The hard plastic core allows for maximal weight application
- Available in Black only

1388452	5.5" H x 5.5" W x 15" L	\$44⁹⁹ EA
----------------	-------------------------	-----------------------------



RECOVERY MASSAGERS

- Improve recovery time by targeting hard to reach muscles and injuries
- Perform deep tissue self-massage and increase blood flow to muscles
- Improve flexibility and range of motion in muscles

1455214	Dual Massage Ball	\$18⁹⁹ EA
1455215	Massage Bar	\$34⁹⁹ EA



FOAM ROLLERS

- Available in 3 firmness levels, medium-firm White PE foam, firm Blue EVA foam, extra-firm Black Molded foam
- Helps develop balance, postural alignment and flexibility
- Ideal for self-myofascial release and massage therapy

1377211	White - 36" x 6" Round - Medium Firm	\$37⁹⁹ EA
1277111	Blue - 36" x 6" Round - Firm	\$79⁹⁹ EA ★
1277128	Blue - 18" x 6" Round - Firm	\$49⁹⁹ EA ★
1377212	Black - 36" x 6" Round - Extra Firm	\$42⁹⁹ EA



BOSU®



BOSU® PRO TRAINER

- Targets the core muscles of your body helping you to not only gain strength, trim, and tone, but to help coordinate your entire body
- Ideal for static and dynamic balance training
- Can also be used to integrate balance challenges into cardiovascular, endurance, core and flexibility training
- Can be used with the platform side either up or down to challenge balance with different body positions
- Includes a workout DVD, an inflation pump, a healthy diet guide for weight loss and a 120 page integrated balance training book
- Supports up to 300 lbs.
- 25" diameter x 12"H

1205732

For the Instructor

\$319⁹⁹ EA



BOSU® POWER STAX

- BOSU Stax increases the intensity of your workout at different heights
- Creates unlimited options for advanced exercises and explosive power and agility drills
- Each BOSU Stax measures 24"W x 3"H
- BOSU balance trainer sold separately

1375490

Single

\$139⁹⁹ EA

1375530

Set of 3

\$379⁹⁹ SET

BOSU® SPORT BALANCE TRAINER

- New, redesigned smaller version of the original BOSU Balance Trainer and is constructed with the same rim and base style
- The sleek, compact 22" design allows for easy transportation and storage, quick positioning for any type of workout and is ideal for fitness enthusiasts and athletes of all ages
- Includes inflation pump and owners manual
- 250 lbs. maximum user weight

Color Options: **Blue, Pink.**

1388422

Specify Color

\$149⁹⁹ EA



BSN SPORTS™

PLYOMETRIC PLATFORM BSN

- Great for improving explosiveness, speed, vertical jump and endurance
- Constructed of 1" O.D. 16-gauge, fully welded Black powder coated, square steel tubing
- Landing surface area varies by height of box
- Nesting stackable for compact easy storage
- 400 lbs. maximum user weight
- For indoor or outdoor use

1457905	12"H	\$259 ⁹⁹ EA
1457906	18"H	\$269 ⁹⁹ EA
1457907	24"H	\$289 ⁹⁹ EA
1457908	30"H	\$319 ⁹⁹ EA
1457909	36"H	\$349 ⁹⁹ EA
1457910	42"H	\$379 ⁹⁹ EA
1457911	Starter Set (1- 12, 18, 24, 30 in.)	\$899 ⁹⁹ SET
1457912	Advanced Set (1-12, 18, 24, 30, 36, 42 in.)	\$1,499 ⁹⁹ SET



HEAVY DUTY PLYO BOX SET

- Set of 4 Plyo Boxes includes one of each: 12", 18", 24" and 30" high
- Stackable for easy storage
- Large 1 1/8" thick non slip landing surface
- Fully welded steel construction with gray powder coated finish
- Floor protectors for indoor or outdoor use
- Can be used by athletes up to 400 lbs.
- Ships fully assembled



1258318

\$1,149⁹⁹ SET ★



FOAM PLYO BOXES

- Large 30" x 36" landing surface eliminates athlete's fear of missing the box
- Constructed of 100% Naugahyde and premium density polyethylene foam that will not break down, de-laminate or soften over time
- Includes handles, Velcro tabs to secure boxes together and compression vents for air release
- Sold in sets of 3 only: 1- 6", 1- 12", 1- 18"
- 3 in 1 Plyo Cube is 20"H x 24"W x 30"L
- Please be cautious when using plyo boxes on smooth or slick surfaces, boxes can move or slide

60 Day Limited Warranty

1455216	Set of 3	\$999 ⁹⁹ SET
1455257	3 in 1 Plyo Cube	\$579 ⁹⁹ EA
1461813	3" Plyo	\$149 ⁹⁹ EA
1461814	24" Plyo	\$499 ⁹⁹ EA
1461815	Set of 5	\$1,399 ⁹⁹ SET





LEATHER JUMP ROPE

- Ball bearing swivel and foam handles
- 9 1/2' long

2549XXX

\$24⁹⁹ EA ★



REACTOR CHAMPION BARBELL

CABLE SPEED ROPE

- 10'L Low-kink PVC coated steel cable rope
- 6"L lightweight plastic ergonomic handles
- Double bearings in the handle with easy change length feature

1390925

\$24⁹⁹ EA ★



HEAVYWEIGHT SASH ROPES

- Thick sash cord jointed into well shaped hollow handles

2546XXX

8' **\$8⁹⁹** EA ★



WEIGHTED JUMP ROPES

- Durable with padded, swivel handles that allow rope to spin faster, reducing stress on wrists, elbows and shoulders
- 9' length

1024135	1 lb. - Red	\$44⁹⁹ EA ★
1024142	2 lb. - Blue	\$49⁹⁹ EA ★
1024159	3 lb. - Green	\$59⁹⁹ EA ★
1024166	4 lb. - Orange	\$69⁹⁹ EA ★

REACTOR CHAMPION BARBELL

4" AND 6" FITNESS STEPS

- Constructed of high density polyethylene designed for schools, YMCA's, public recreational and health facilities
- Rounded corners reduce the risk of injury from rough edges
- Additional safety features include non-slip, dimpled top and non-skid bottom with rubber feet
- Top surface area is 24"L x 15"W

1292619

Orange 4" Step

\$64⁹⁹ EA ★

1292626

Grey 6" Step

\$74⁹⁹ EA ★



REACTOR CHAMPION BARBELL

FITNESS STEP CART

- Large capacity storage rack and transporter for fitness steps and resistance tubes
- Lightweight and durable
- This cart will safely store up to (32) 4" steps or (16) 6" steps plus resistance tubes
- Features include heavy-duty, ball bearing, swivel, non-marring casters with a roll lock feature
- Easily goes through standard doorway

1188332

60"H x 45"W x 19"D

\$549⁹⁹ EA

LICORICE ROPES

- Perfect for beginners or experienced jumpers who want the best
- Great for speed jumping and a favorite with jump teams
- Injection molded handles designed for comfort and free spin
- Durable, plastic rope

17207XXX

Orange 7' Licorice

\$5⁹⁹ EA

17208XXX

Red 8' Licorice

\$5⁹⁹ EA

17209XXX

Green 9' Licorice

\$5⁹⁹ EA

17210XXX

Black 10' Licorice

\$6⁹⁹ EA



REACTOR CHAMPION BARBELL

POWER ROPE ANCHOR STATION

- Use indoors or outside
- Accommodates up to 12 users at one time
- Solid rubber bottom for floor protection
- Add up to 4 - 45 lb. Olympic weight plates for maximum stability
- All welded, all silver powder coated steel construction
- 6.5"H x 23.5"W x 23.5"D - 32 lbs.
- Power ropes and weight plates sold separately

1375090

\$299⁹⁹ EA ★



FITNESS POWER ROPES

- Various lengths and diameters to enhance the overall work-out experience
- Great for grip strength, stamina and overall conditioning
- Ideal for upper body and core exercises

1369620	1.5"D - 30'L	\$189⁹⁹ EA ★
1369621	1.5"D - 40'L	\$239⁹⁹ EA ★
1369622	1.5"D - 50'L	\$271⁹⁹ EA ★
1369624	2"D - 30'L	\$284⁹⁹ EA ★
1369625	2"D - 40'L	\$339⁹⁹ EA ★
1369626	2"D - 50'L	\$389⁹⁹ EA ★

BEST SELLER

REACTOR
CHAMPION BARBELL

QUICK RELEASE TETHER

- Combines fixed resistance with overload release for explosive speed training
- Partner-activated release frees tether from belt for a burst of speed
- Durable nylon mesh tether features reinforced stitching and a dual grip handles

1301793 \$59⁹⁹ EA



REACTOR
CHAMPION BARBELL

POWER DRIVER

- Connect together, back-to-back and attempt to pull the other while staying parallel to the ground
- Trains explosive position and allows hip flexors to fire at maximum velocity
- Includes two heavy-duty padded harnesses, a nylon mesh tether with reinforced stitching and easy-attach steel clips

1301861 \$89⁹⁹ EA



REACTOR
CHAMPION BARBELL

DUAL RESISTANCE HARNESS

- One athlete provides resistance while the other runs
- Running positions can be alternated quickly for interval training
- Adjustable 3" waist belt
- Includes carry bag

1143591 \$74⁹⁹ EA ★



REACTOR
CHAMPION BARBELL

SHOULDER RESISTANCE HARNESS

- Strong harness for developing maximum stamina, strength, and power for running in proper form
- 10'L handled tether attaches to shoulder harness with adjustable waist belt
- Includes carry bag

1143584 \$92⁹⁹ EA ★



REACTOR
CHAMPION BARBELL

360° BELT SET

- Continuous belts without buckle closures allow heavy-duty steel rings full rotation without hindrance
- Use to increase first-step explosion, back pedaling speed and lateral quickness
- Includes 5 belts (color-coded by size), 8' long latex cord in nylon sheathing, and a safety cuff that tethers to the wrist

1301892 \$119⁹⁹ EA

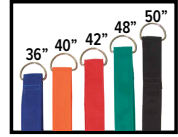
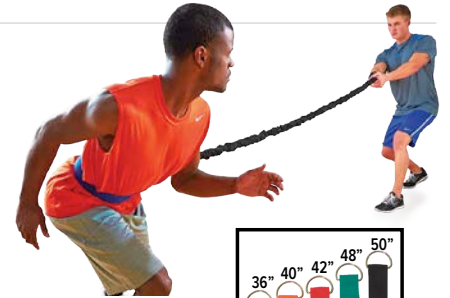

REACTOR
CHAMPION BARBELL

SPEED CHUTE

- Provides excellent resistance while running to improve speed, stamina, strength and acceleration
- Chute releases while running to provide resistance
- Includes carry bag

1143607 40" Diameter \$59⁹⁹ EA ★
1143614 48" Diameter \$69⁹⁹ EA ★
1273694 54" Diameter \$74⁹⁹ EA ★



REACTOR
CHAMPION BARBELL

WEIGHT VEST

- Great for speed and power training
- Secure and comfort fitting straps for maximum movement of your arms, shoulders, and neck
- Adjustable from 1 lb. to 20 lbs. (weight packs included)

1369608 20 lbs. \$99⁹⁹ EA ★



REACTOR
CHAMPION BARBELL

X-FINITY WEIGHT VEST

- Comfortable form fitting ergonomic fitness vest
- Breathable design offers adjustable quick release chest buckle, reflective stripes (front and rear) and a secure pocket for your cell phone
- Do not machine wash or soak in water
- One size fits most

1395594 6 lb. - Grey \$69⁹⁹ EA ★
1395595 10 lb. - Black \$89⁹⁹ EA ★



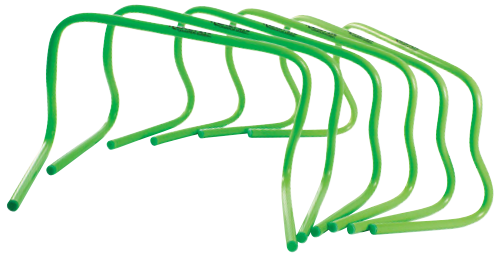

REACTOR
CHAMPION BARBELL
BANANA STEPS

- Molded tubular PVC construction
- Helps improve quickness and agility
- Designed to absorb impact or fall forward if struck, decreasing the likely hood of training related injuries
- 12"H x 17"W x 8"D
- Sold individually

1390931 \$29⁹⁹ EA ★



PORTaPIT
MULTI-HEIGHT FLEX HURDLE

- Lightweight multi-height flexible PVC hurdle can be converted into two heights 6" or 12" by folding legs in reverse directions
- Helps improve quickness and agility
- Hurdles can be positioned for plyometric jumps or running drills
- Sold in sets of 4

1202076 \$99⁹⁹ SET OF 4 ★



REACTOR
CHAMPION BARBELL
FIXED RUNG AGILITY LADDER

- Ideal for developing quick and accurate foot speed, increased balance and coordination
- Each ladder is 15'L x 20"W with ten sections
- Rugged 1" wide webbing with end buckles allow various shape configurations for a more diversified workout
- Connecting buckles allow for additional ladders for longer runs and different formations
- Includes carry bag

1271560 \$64⁹⁹ EA ★



REACTOR
CHAMPION BARBELL
LOW PUSH/PULL TRAINING SLED

- Increase speed, explosion, leg strength and endurance
- Large radius handle allows for multiple grip locations
- 12"H x 2" O.D. post will hold up to 315 lbs. of Olympic plates (sold separately)
- One piece welded construction, 1.9" silver powder coated steel tubing
- Waist and shoulder harness is fully adjustable with quick release attachment and double safety tethers
- 14"H x 23"W x 38"L - 25 lbs

1375098	Sled and Harness	\$599 ⁹⁹ EA ★
1375084	Sled Only	\$499 ⁹⁹ EA ★
1240054	Harness and Tether Only	\$59 ⁹⁹ EA ★



JUKE 360

- 8 ft stretch cord safely extends to 20 ft
- Adjustable belt with free slid ring for movement in any direction
- 10 different drill cards for training & practicing

60 Day Limited Warranty
1455208 \$41⁹⁹ EA ★



HEXA RINGS

- Snap together to create a variety of designs or connect to create a straight ladder
- Includes 6 hexagon pieces, 12 supporting pieces, and carrying bag
- Hexagon ladder size: 19"(L) x 21"(W)

1454873 \$49⁹⁹ SET ★



JUMP TRAINER

- Padded adjustable belt and ankle straps fit most sizes comfortably
- Quick release power tubes are easily added and removed
- Durable latex tube construction to withstand dynamic exercises

60 Day Limited Warranty
1455212 \$41⁹⁹ EA ★



PEDOMETERS AND ACCELEROMETERS

ONE

- Perfect for your 10,000 step per day program.
- Includes: step counter w/extra large digital display, hinged protective cover, loss prevention strap, spring-loaded alligator clip and user changeable battery
- Class Pack includes: 32 Pedometers, 32 loss prevention straps, and 2 storage cases

5 Year Limited Warranty

1277210

\$17⁹⁹ EA ★

1377238

One Class Pack of 32

\$619⁹⁹ PACK OF 32 ★



ONE.5

- No moving parts = no clicking sound
- Tests more accurate than spring-levered and spring-activated pedometers
- Keeps its accuracy even when tilted
- User-friendly and offers greater motivation and goal setting tools for every walker
- Includes: steps, piezoelectric motor, clam shell, alligator clip, loss prevention strap and user changeable battery
- Class Pack option includes: (32) Accelerometers, (2) storage cases

5 Year Limited Warranty

1376380

\$22⁹⁹ EA ★

1377241

Class Pack

\$725⁹⁹ PACK OF 32 ★



THREE.5

- All of the same specifications as the Ekho "One.5" and "Two.5" plus activity time and calories
- Class Pack option includes: (32) accelerometers and (2) storage cases

5 Year Limited Warranty

1376382

\$21⁹⁹ EA ★

1377243

Class Pack

\$675⁹⁹ PACK OF 32 ★

BEE-FIT PEDOMETERS

BEE-FIT PEDOMETERS

- Meets NASPE Standards
- Busy Bee includes: counts steps, extra large digital display, durable construction with hinged cover, loss prevention strap, spring loaded alligator clip and user changeable batteries
- Worker Bee includes distance, activity time and calories
- Class Packs includes (2) 16 unit carrying cases

5 Year Limited Warranty

1216769

Worker Bee Yellow

\$20⁹⁹ EA ★



HEART RATE MONITOR STICK

- "Stick" style pulse monitor with large sensor pads for an accurate reading
- Provides a readout of your pulse in 10 - 15 seconds
- Features a large, easy to read display screen
- Replaceable 9V battery

1399689

\$49⁹⁹ EA ★





PUSH-UP CHALLENGER

- Provides the teacher and student an effective way to test each individual push up fairly and consistently, while teaching the proper mechanics of the push up
- The student lowers their body to touch their chest to the PUSH-UP CHALLENGER, almost guaranteeing their arms are at a right angle
- The push-up tester is now being used by many for Fitnessgram
- Stackable for easy storage

1377081 \$184⁹⁹ DZN ★



CURL UP STRIPS

- Durable rubber non-skid strips are used by placing them under the knees when performing the curl up assessment
- The starting position is with the fingertips on one edge of the strip
- The width of the measuring strip determines how far the student needs to curl up
- Available in two widths depending on the age of the students

1377661 3"W (5-9 Year Olds) \$7⁹⁹ EA
1377662 4 1/2"W (Ages 10 and Up) \$8⁹⁹ EA

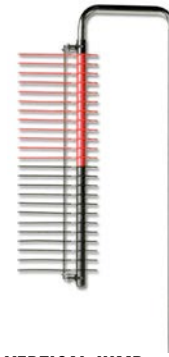

VERTICAL JUMP CHALLENGER

- Telescopes from 4 to 12 feet
- Heavy duty base and casters for stability and portability
- Moveable metal arms placed at 1" increments
- Highest arm reached during jump reading is measured
- Includes handy reset pole
- Weight plates not included

1245448 \$599⁹⁹ EA



PUSH UP TRAINING MAT

- Colorful, poly-vinyl mat teaches the proper push up technique
- The attached foam piece assures the child is safely executing the push up
- Instructions are embossed right on the mat

1267167 \$54⁹⁹ EA



CURL-UP MAT

- Screened on lined mat ensures that students do curl-ups properly
- One end is for 3" and the other end for 4 1/2" for testing all ages
- Lightweight, soft, foam mat rolls up for easy storage

1388274 48"L x 24"W x 5/16" \$39⁹⁹ EA ★

CARPETED LONG JUMP MAT

- Carpet on top and non-slip bottom
- Measures long jump distance
- Measures up to 10' in 2" increments

1268928 Carpet size - 12'L x 30"W \$129⁹⁹ EA ★

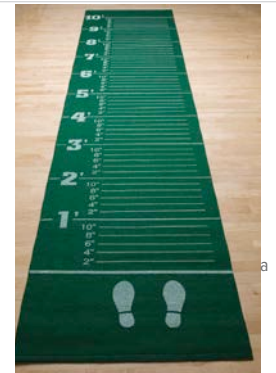

BASELINE

BASELINE FLEX TESTER

- Scales printed in inches and centimeters
- For use with any fitness program measuring flexibility
- Sturdy construction with built-in footplate and maximum stretch indicator that remains in place until reset
- Deluxe edition offers extra features such as enabling test protocols to vary the scale starting point and an adjustable reach indicator allowing for variations
- Assembly is required

1375499 Standard \$189⁹⁹ EA
1375500 Deluxe \$279⁹⁹ EA

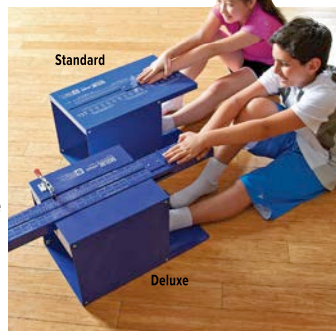

FLEXIBILITY ASSESSMENT TESTER

- Durable, powder coated steel construction with non-skid, non marring base
- For use with Fitnessgram®, SHAPE, Cooper Institute and YMCA programs
- Foot plates fold flat for easy storage and transport
- Smooth glide reach indicators with easy to read English and Metric calibration
- Assembly required

1378689 Single - 26"L x 15"W x 12.5"H \$139⁹⁹ EA ★
1378691 Double - 38"L x 15"W x 12.5"H \$219⁹⁹ EA ★





- Perfect for basketball courts, gymnastics areas, wrestling facilities, rehab centers and more
- Installs easily and the brightly colored pads will enhance the appearance of your facility
- Made of 7/16" thick wood backing, 18 oz. vinyl, and have a 1" lip at the top and bottom for attachment to the wall
- We recommend our Aluminum Channeling for mounting your wall pads, but they can be bolted in place - hardware not included
- Covered material meets California Fire Marshall's specifications for flammability

WALL PADS WITH GRAPHICS

1 3/8" Crosslink Polyethylene

20028347	2' x 5' x 13/8"	\$339 ⁹⁹ EA	
20028353	2' x 6' x 13/8"	\$424 ⁹⁹ EA	
20028360	2' x 7' x 13/8"	\$382 ⁹⁹ EA	

2" High Density Polyurethane

20028351	2' x 5' x 2"	\$335 ⁹⁹ EA	
20028358	2' x 6' x 2"	\$359 ⁹⁹ EA	
20028364	2' x 7' x 2"	\$376 ⁹⁹ EA	

2 1/2" Combination Wall Pads

20028349	2' x 5' x 2 1/2"	\$353 ⁹⁹ EA	
20028355	2' x 6' x 2 1/2"	\$364 ⁹⁹ EA	
20028362	2' x 7' x 2 1/2"	\$417 ⁹⁹ EA	

WALL PADS WITHOUT GRAPHICS*

1 3/8" Crosslink Polyethylene

20028348	2' x 5' x 13/8"	\$286 ⁹⁹ EA	
20028354	2' x 6' x 13/8"	\$346 ⁹⁹ EA	
20028361	2' x 7' x 13/8"	\$312 ⁹⁹ EA	

2" High Density Polyurethane

20028352	2' x 5' x 2"	\$287 ⁹⁹ EA	
20028359	2' x 6' x 2"	\$289 ⁹⁹ EA	
20028365	2' x 7' x 2"	\$318 ⁹⁹ EA	

2 1/2" Combination Wall Pads

20028350	2' x 5' x 2 1/2"	\$299 ⁹⁹ EA	
20028356	2' x 6' x 2 1/2"	\$323 ⁹⁹ EA	
20028363	2' x 7' x 2 1/2"	\$349 ⁹⁹ EA	

COLOR CHOICES: Choose from 14 school colors, in solids or alternating panel colors.
Due to dye lots and natural variations, vinyl colors may vary slightly if ordered at separate times.

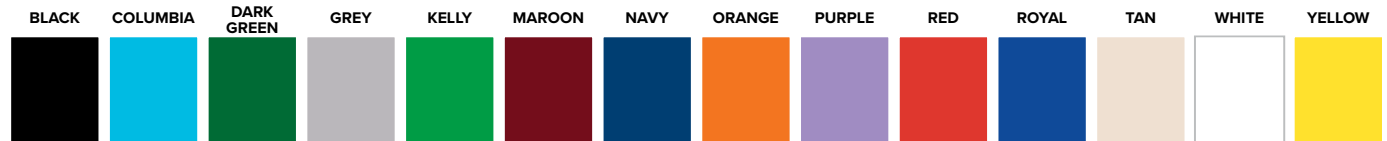

ALUMINUM CHANNELING FOR WALL PADS

- Fastest and easiest method for attaching wall padding to your walls
- Pads fit into the channeling securely and lock-in at the top for a smooth, neat appearance (no ugly bolts or screws to cover up)
- Worn or damaged pads can be easily removed and replaced one panel at a time by simply removing the top channel
- Includes top and bottom channels
- Sold in 6' lengths



6870YXXXDS 6" Aluminum Channeling \$79⁹⁹ SET



CUT OUT FOR WALL PADS AND I-BEAM PADS

WALL PAD ACCESSORIES

20028346	Cut Out	\$139 ⁹⁹ SET	
20028345	Corner Pad	Call for Pricing	





FLAME RETARDANT WALL PADS

- Class A pads are constructed of 7/16" OSB Board, with 2" highly flame resistant polymerized open cell foam and covered with 16 oz. FR rated vinyl
- Pads have a 1" lip top and bottom for attachment to the wall
- Corner round molding or aluminum channel (**not included**) may be used to cover bolt heads after installation (**installation hardware is not included**)
- Pads comply with the standards set forth by ASTM E84
- Meets NFPA 255, UL 723, ANSI 2.5 and UBC 8-1 (42-1)
- Available colors: Black, Columbia Blue, Dark Green, Grey, Kelly Green, Maroon, Navy Blue, Orange, Purple, Red, Royal Blue, Tan, White and Yellow

CERTIFICATE OF COMPLIANCE



With Graphics

1248029	2' x 5' x 2"	\$549 ⁹⁹ EA	
1248036	2' x 6' x 2"	\$649 ⁹⁹ EA	
1248043	2' x 7' x 2"	\$679 ⁹⁹ EA	

Without Graphics

1247992	2' x 5' x 2"	\$349 ⁹⁹ EA	
1248005	2' x 6' x 2"	\$479 ⁹⁹ EA	
1248015	2' x 7' x 2"	\$499 ⁹⁹ EA	



I-BEAM PADS

- Designed to minimize the risk for injury from contact with a steel support I-beam
- Crafted to provide maximum protection, durability and ease of installation
- Pads are 6' H, covered with 18 oz. vinyl and filled with 4" high density polyfoam
- Fits beams up to 8" wide
- Available in Black, Columbia Blue, Dark Green, Grey, Kelly Green, Maroon, Navy Blue, Orange, Purple, Red, Royal Blue, Tan, White or Yellow
- Please specify color

G862YXXXDS \$519⁹⁹ EA



COLUMN PADS

- Provide protection against collisions with support posts and poles
- Easily installed and enhances the appearance of your facility
- Available for both free-standing and in-wall supports

CALL FOR MORE INFO & PRICING



MADE IN 8" WIDE SECTIONS

STAGE PADS

- If your gymnasium is also used as an auditorium or theater, you need our stage pads to reduce the chance of injury
- Custom made to your specific application
- The inboard side of the fold is beveled so the edge of the stage is fully padded
- Fastener strips are included to prevent the pad from shifting, sliding or detaching while in use
- Manufactured using 1 3/8" crosslink polyethylene foam covered in 18 oz. vinyl
- Available in Black, Columbia Blue, Dark Green, Grey, Kelly Green, Maroon, Navy Blue, Orange, Purple, Red, Royal Blue, Tan, White or Yellow
- Please specify color

CALL FOR MORE INFO & PRICING

COLOR CHOICES: Choose from 14 school colors, in solids or alternating panel colors.
Due to dye lots and natural variations, vinyl colors may vary slightly if ordered at separate times.



DELUXE GYM FLOOR COVERS

BUILT TOUGH TO PROTECT YOUR INVESTMENT!

- Ultra-durable 3-ply fabrics
- Reinforced polyester mesh yarns coated with PVC on both sides
- Seams are engineered to be as strong as the fabric itself (Meets Military and Dept. of Defense requirements)
- Use either side – will lay smooth and flat
- Fabric is anti-bacterial, anti-fungal and rot and mildew resistant
- Meets stringent flame retardant standards including California Fire Marshall, NFPA 701 and UL 300
- Order in 10' wide sections adding 6" – 12" for overlapping
- Example: For a 75' x 110' floor, order 8 sections 10' x 110'

1369726	18 oz., 8 Yr. Warranty	\$1 ²⁵ SQ.FT
1048315	22oz., 10 Yr Warranty	\$1 ⁹⁹ SQ.FT
1083743	27 oz., 15 Yr Warranty	\$1 ⁷⁹ SQ.FT
1270433	32 oz., 17 Yr Warranty	\$2 ⁰⁹ SQ.FT

18 OZ. COLOR OPTIONS:

Black, Burgundy, Green, Kelly Green, Light Gray, Navy Blue, Orange, Red, Royal Blue, Tan, Yellow

22 OZ. COLOR OPTIONS:

Black, Brown/Tan, Burgundy, Green, Light Gray, Navy Blue, Red, Royal Blue, Tan, Tan/Royal Blue, Yellow

27 & 32 OZ. COLOR OPTIONS:

Black, Brown/Tan, Burgundy, Dark Gray, Green, Navy Blue, Red, Royal Blue, Tan, Tan/Royal Blue



Actual colors may vary.

***ADA COMPLIANT. COLORS MAY VARY.**

SAVE BY PURCHASING PRE-CUT COVERS!



***ADA COMPLIANT.**

PRE-CUT GYM FLOOR COVERS

- Durable, vinyl cover protects your gym floor during non-athletic events
 - Covers are already cut to 10'W x 100'L sections
- Color Options: **Royal Blue, Tan.**

1369718	18 oz., 8 Yr. Warranty	\$1,599 ⁹⁹ EA	
1162677	22 oz., 10 Yr. Warranty	\$1,949 ⁹⁹ EA	
1375308	27 oz., 15 Yr Warranty	\$2,199 ⁹⁹ EA	
1375310	32 oz., 17 Yr Warranty	\$2,299 ⁹⁹ EA	



GREY

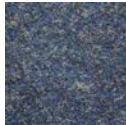

BLUE

PRO SHIELD GYM FLOOR COVER TILE

- Beautiful acoustic carpet tiles for all kinds of events
- No need for tape, tiles will lie flat and won't slide
- 100% solution-dyed polypropylene top surface and a non-staining polyolefin backing
- Lightweight for quick set up and breakdown
- Approximately 39 3/8" x 78 3/4" (22 lbs. per tile)

3 Year Limited Warranty

Color Options: **Blue, Grey.**

1384778	Specify Color	\$85 ⁹⁹ EA	
---------	---------------	-----------------------	--

PRO SHIELD GYM FLOOR TILE CART

- Stores and transports your gym floor cover tiles
- Steel frame with a carpeted plywood platform
- Features 5" casters and removable 29" handle
- 950 lb. capacity (70-80 tiles)

3 Year Limited Warranty

1384780	80"L x 43"W	\$999 ⁹⁹ EA	
---------	-------------	------------------------	--

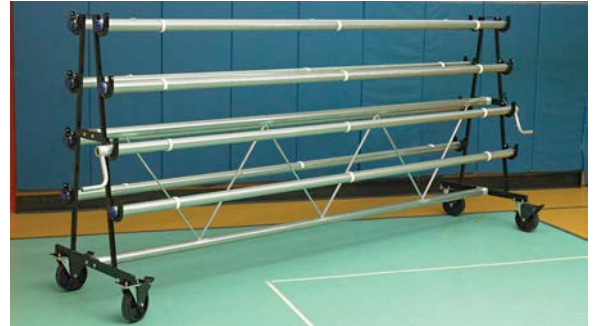

GYM FLOOR COVER MOBILE STORAGE RACKS

- Use with 10' wide sections only
 - All steel rack with Delrin roller bearings
 - Supports up to 2800 lbs.
 - Four 8" diameter non-marring wheels for easy rolling (2 with locks)
 - Includes 2 hand cranks for winding, 3 fabric clips per roller, and instructions
 - 2 1/2" diam., 14 gauge steel rollers with locks to prevent accidental unwinding
 - 67"H x 34"W x 12'6"L
- 6 Year Limited Warranty**



1048407	6 Roller Model	\$4,199 ⁹⁹ EA	
1048414	8 Roller Model	\$5,499 ⁹⁹ EA	
1048421	10 Roller Model	\$5,699 ⁹⁹ EA	

FLOOR COVER TAPE DISPENSERS

- For floor cover tape up to 3" wide

1. 1270419	Hand Held	\$64 ⁹⁹ EA
2. 1270426	Upright Walk Behind	\$479 ⁹⁹ EA

FLOOR COVER TAPE

- Secures overlaps and edges without leaving residue on floor or cover
- Purchase two cases of tape and receive a "FREE" walk behind tape dispenser (1 per customer)

3. 1270587	16 Rolls - 3" X 36 yds	\$279 ⁹⁹ CASE
------------	------------------------	--------------------------



RACK BRUSH ASSEMBLY

- Bolts to the rack to remove debris from your floor cover as you roll it up

1248647	\$1,349 ⁹⁹ EA
---------	--------------------------



ELECTRIC POWER WINDER

- Quickly and easily winds up each gym floor cover section

1048438	\$1,999 ⁹⁹ EA	
---------	--------------------------	--



BONDED-FOAM MATS

Firmer Than Polyfoam Mats, But Softer Than Polyethylene Mats!

- Perfect for tumbling, exercise, play and low impact gymnastics by elementary and middle school age children
- Top quality 2" thick bonded foam mat designed for comfort and moderate support
- Nylon reinforced tough 18 oz. vinyl cover uses double reinforced, nylon stitched inverted seams to create a smooth working surface
- Mats have 2' panels and folds

*4' X 8' MAT SHOWN
Specify Color(s) when ordering!*

BONDED-FOAMMATS

MAT SIZE	HOOK & LOOP FASTENER OPTIONS								
	NONE			ENDS ONLY			ALL SIDES		
	ITEM #	ROYAL	CUSTOM	ITEM #	ROYAL	CUSTOM	ITEM #	ROYAL	CUSTOM
4' x 8'	1280807	\$459 ⁹⁹ ★	\$479 ⁹⁹ ★	1041903	\$589 ⁹⁹ ★	\$609 ⁹⁹ ★	1041484	\$599 ⁹⁹ ★	\$619 ⁹⁹ ★
5' x 10'	1280814	\$649 ⁹⁹ ★	\$669 ⁹⁹ ★	1041927	\$839 ⁹⁹ ★	\$859 ⁹⁹ ★	1041507	\$879 ⁹⁹ ★	\$899 ⁹⁹ ★
6' x 12'	1280821	\$1,099 ⁹⁹ ★	\$1,299 ⁹⁹ ★	1041941	\$1,199 ⁹⁹ ★	\$1,219 ⁹⁹ ★	1041521	\$1,249 ⁹⁹ ★	\$1,269 ⁹⁹ ★



ULTIMAT[®]

Our Firmest and Lightest Mat!

- Provides firm support for high impact activities
- Use in physical education and gymnastic classes, cheerleading and martial arts training and more
- 1 3/8" firm cross-linked foam covered in tough 18 oz. vinyl
- Cover resists abrasions, tears, fungus and mildew
- Mats have 2' panels and folds

WALL MOLDING STRIPS

- Attach permanently to wall for hanging mats with fasteners on 4 sides
- 1 5/8" wide hook and loop fastener strip holds mats to wall
- Sold in 6' sections

1044782DS Specify Hook or Loop Fasteners \$74⁹⁹ SET

ULTIMAT

MAT SIZE	HOOK & LOOP FASTENER OPTIONS								
	NONE			ENDS ONLY			ALL SIDES		
	ITEM #	ROYAL	CUSTOM	ITEM #	ROYAL	CUSTOM	ITEM #	ROYAL	CUSTOM
4' x 6'	1280838	\$289 ⁹⁹ ★	\$309 ⁹⁹ ★	1257915	\$329 ⁹⁹ ★	\$359 ⁹⁹ ★	1257922	\$329 ⁹⁹ ★	\$349 ⁹⁹ ★
4' x 8'	1280845	\$349 ⁹⁹ ★	\$369 ⁹⁹ ★	1041880	\$419 ⁹⁹ ★	\$439 ⁹⁹ ★	1041545	\$399 ⁹⁹ ★	\$419 ⁹⁹ ★
5' x 10'	1280852	\$529 ⁹⁹ ★	\$549 ⁹⁹ ★	1041965	\$569 ⁹⁹ ★	\$589 ⁹⁹ ★	1041569	\$599 ⁹⁹ ★	\$619 ⁹⁹ ★
6' x 12'	1280869	\$649 ⁹⁹ ★	\$669 ⁹⁹ ★	1041989	\$679 ⁹⁹ ★	\$699 ⁹⁹ ★	1041583	\$689 ⁹⁹ ★	\$709 ⁹⁹ ★

COLOR CHOICES: Choose from 14 school colors, in solids or alternating panel colors.
Due to dye lots and natural variations, vinyl colors may vary slightly if ordered at separate times.



EXPANDO NOVA DUO LAYERED-FOAM MATS

Combines the Soft Cushion of Polyfoam with the Firm "no bottoming" Trait of Polyethylene!

- Perfect for young, beginner or intermediate tumblers
- A 1" layer of polyfoam provides the softness for younger, lightweight children, while a firmer 1 3/8" polyethylene layer keeps the mat from "bottoming out" during more extensive use
- Nylon reinforced tough 18 oz. vinyl cover uses double reinforced, nylon stitched inverted seams to create a smooth working surface
- Mats have 2' panels and folds and are lightweight for easy handling and storage
- **Fasteners on ends only**



**1" POLYFOAM LAYER
A FIRMER 1 3/8"
POLYETHYLENE LAYER**

CODE	MAT SIZE	COLOR MATS	
		PRICE	DELIVERY
1054644DS	4' x 6'	\$599 ⁹⁹	
1044263DS	4' x 8'	\$649 ⁹⁹	
1044270DS	5' x 10'	\$999 ⁹⁹	
1044287DS	6' x 12'	\$1,199 ⁹⁹	

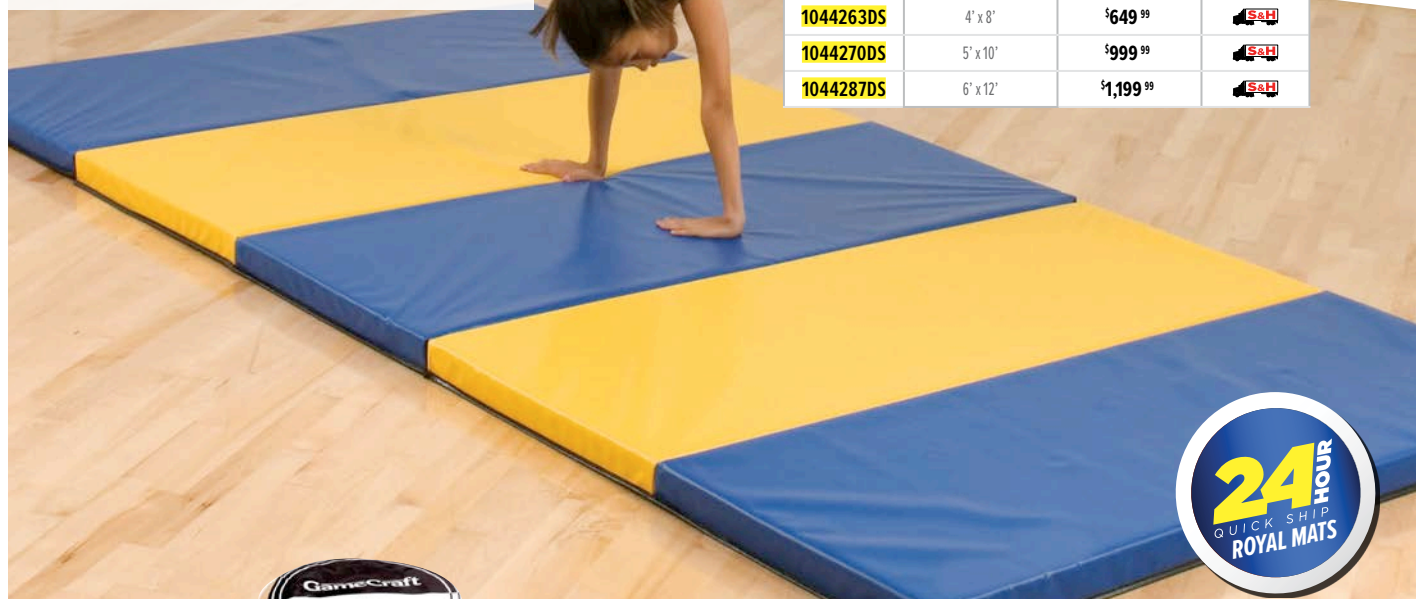

MAT TAPE

- Easy to use and remove
- Will not stretch out
- Secures overlaps

6411XXX	3" x 84'	\$29 ⁹⁹	ROLL ★
6406XXX	4" x 84'	\$29 ⁹⁹	ROLL ★



MAT CART

- A durable, PVC mat truck transports and stores mats of all sizes
- Lightweight cart is easily maneuvered by one person
- The convenient handle folds flat for easy storage
- Some assembly required

1246155	7"H x 22"W x 66"L	\$549 ⁹⁹	EA
----------------	-------------------	---------------------	----



MATT-KLEEN™ ALL PURPOSE DISINFECTANT CLEANER

- Helps stop the spread of skin diseases and infections
- Ideal for wrestling and gymnastic mats, training tables and shower floors
- Highly concentrated; 2 oz. makes one full gallon

1092479	Gallon	\$129 ⁹⁹	EA
----------------	--------	---------------------	----



WHIZZER®

- Multipurpose concentrate kills HIV-1 (AIDS virus), MRSA, Hepatitis B & C, and other viruses. Kills strep, staph and fungus germs on contact.
- Cleaner, fungicide, mildewstat, virucide and deodorizer - all in one. Comes complete with 2 FREE Pint spray bottles.
- Economical. One ounce of concentrate mixed with water makes a gallon of full-strength disinfectant. 128 dilutions per gallon.
- Fast. Apply directly to mats, floors, walls, training tables, locker rooms, or personal items. Just wipe dry.

30 Day Limited Warranty

MU230201	1 Gallon + 2 FREE Pint Spray Bottles	\$119 ⁹⁹	CASE
-----------------	--------------------------------------	---------------------	------

COLOR CHOICES: Choose from 14 school colors, in solids or alternating panel colors. Due to dye lots and natural variations, vinyl colors may vary slightly if ordered at separate times.





EZ-FLEX CARPET ROLL

- Made from soft but durable 26 oz. needle punch carpet and lightweight crossed-link polyethylene sports foam
- Each roll includes the flexible rolling system for fast, easy set up and storage
- Indestructible flame-laminated bond between the carpet and the foam
- Includes one 4" roll of hook fastener per seam (orders of 2 or more rolls)
- A full floor consists of 7 rolls 6' x 42' which combine to create a 42' square surface

3 Year Limited Warranty

Color Options: **Black, Blue, Charcoal Grey, Grey, Purple, Red, Teal.**

1450124	6' x 42' x 1 3/8" Roll (Specify Color)	\$1,399 ⁹⁹ EA	
1450132	6' x 42' x 2" Roll (Specify Color)	\$1,799 ⁹⁹ EA	



COLOR OPTIONS

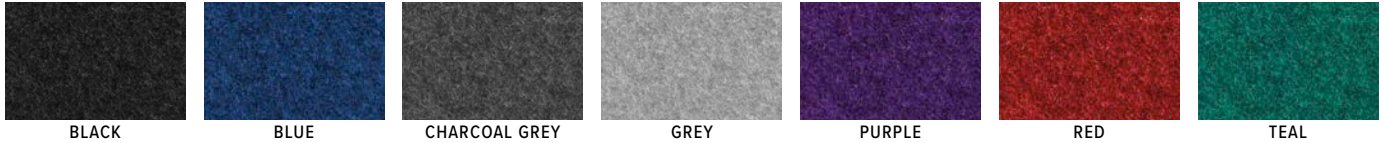

EXPANDO SUPERNOVA MATS

Our Softest Mat for Low Impact Activities With Very Young Users!

- For teaching basic gymnastics & exercises to children ages 3-9
- So light young children can move and store them
- Nylon reinforced tough 18 oz. vinyl cover uses double reinforced, nylon stitched inverted seams to create a smooth working surface
- Mats have 2' panels and folds
- **Fasteners on Ends Only**



2" 100 ILD POLYFOAM



4' X 8' MAT SHOWN

CODE	SIZE	COLOR MATS	
		PRICE	DELIVERY
1044300DS	4' x 6'	\$449 ⁹⁹	
1044324DS	4' x 8'	\$624 ⁹⁹	
1044348DS	5' x 10'	\$799 ⁹⁹	



SOFLAN LANDING MATS

- Provide additional cushion to build confidence
- Covered in 18 oz. coated vinyl, topped with nylon mesh breather fabric and filled with semi-firm polyfoam
- Strategically placed nylon web handles are securely attached
- Available colors: Black, Dark Green, Dark Purple, Grey, Kelly Green, Light Blue, Navy Blue, Orange, Red, Royal Blue, Tan, White and Yellow
- Please allow 6 weeks for delivery

8" Thick Landing Mats

G785YXXDS	5' x 10' Folding	\$1,599 ⁹⁹ EA ★	
G786YXXDS	6' x 12' Folding	\$2,399 ⁹⁹ EA ★	
G788YXXDS	8' x 12' Folding	\$2,999 ⁹⁹ EA ★	
G904YXXDS	4' x 8' Non-Folding	\$899 ⁹⁹ EA ★	
G905YXXDS	5' x 10' Non-Folding	\$1,349 ⁹⁹ EA ★	
G906YXXDS	6' x 12' Non-Folding	\$2,199 ⁹⁹ EA ★	

12" Thick Landing Mats

G935YXXDS	5' x 10' Folding	\$2,299 ⁹⁹ EA ★	
G936YXXDS	6' x 12' Folding	\$2,949 ⁹⁹ EA ★	

GYM CHALK

- For weight-lifting or gymnastics
- Conveniently wrapped in 2 oz. blocks
- Eight blocks per 1 lb. package

PGE4360X \$29⁹⁹ LB ★

HD INFLATOR

- 1/6 horsepower AC motor
- 80psi with pressure gauge
- Includes needle and tire valve
- Weight: 8 lbs.

1240672 \$329⁹⁹ EA ★



ECONOMY ELECTRIC INFLATOR

- High impact plastic desktop inflator
- 120v and .9 amps
- 100 psi gauge
- Coiled inflation tube that will stretch to 30"
- Comes with needle and other inflation valves

MSECOLEY \$149⁹⁹ EA ★



STEEL HAND INFLATOR

- Compact, lightweight and portable
- Made of heavy duty steel to last through the years
- Needle included

MSHNINFSY \$12⁹⁹ EA ★



HEAVY DUTY UPRIGHT PUMP

- 21" reinforced hose
- In-line gauge provides correct pressure for all types of balls
- Needles sold separately

1069273 \$26⁹⁹ EA ★

INFLATING NEEDLES

- MSNEDPAC6** Needle Pack \$6⁹⁹ PACK OF 6 ★
- MSNED100** Pack of 100 \$39⁹⁹ PACK OF 100 ★
- 1369558** Digital Pressure Gauge \$44⁹⁹ EA ★



DOUBLE ACTION HAND PUMP

- Compact, lightweight and portable
- Pump twice the volume of air with dual action
- Needle included

1369557 \$12⁹⁹ EA ★

AIRMAN® CORDLESS

- Simple one handed, push button operation
- Will inflate anything from balls to bicycle tires
- 9.6v rechargeable nicad battery
- 120 psi gauge
- Includes AC power cord and charger and 12v DC cord

22006XXX \$119⁹⁹ EA



SKYSCAN™ TI-PLUS HEAT INDEX WARNING SYSTEM

- Easy to read arrow display showing all ranges of dangerous heat conditions
- Audible warning sounds before heat index reaches critical levels
- Accurate display temperature, relative humidity and heat index
- Critical info is stored in memory for 24 hrs. and can be re-displayed
- Also functions as a countdown timer, stopwatch and alarm

1150216 \$169⁹⁹ EA



STRIKE ALERT HD LIGHTNING DETECTOR

- Intuitive Graphical display
- Shows lightning strike distance up to 40 miles away
- Displays 1-hour storm trend and intensity
- Tells you how long lightning has stopped so play can resume
- Offers 360 degree storm tracking in all directions
- Audible and vibrating warnings
- Low power consumption using two AA batteries

1384282 \$329⁹⁹ EA



SKYSCAN™ P5 LIGHTNING DETECTOR

- Detects lightning as far as 40 miles away and accurately ranges its approach by both an audible tone and by four LED's which are ranged in miles (0-3, 3-8, 8-20, 20-40)
- Requires (2) 9V batteries (not included)
- AC adapter not included
- Rugged weather resistant case

SKYSCANX Portable Unit \$349⁹⁹ EA
20026502 110v AC Adapter \$49⁹⁹ EA



EPIK

- The Fox 40 Classic Epik has the authentic Classis sound in a sleek design and integrated co-molded Cushioned Mouth Grip (CMG)
- No moving parts to freeze, jam or deteriorate
- Chambers are designed to self-clear when submerged in water
- Assortment includes: 2 black, 2 red, 2 orange, 2 yellow, 1 pink, 1 blue, 1 green, and 1 white

1458128 Assorted Colors with Lanyard \$79.99 DZN



NEW!



LAUNDRY LOOPS

- The fastest and most effective way to wash laundry in the team environment
- Each player loops clothes prior to washing
- Each item is washed and dried while attached to loop
- Built in sock loop and name tag

Color Options: Black, Royal, Scarlet, White.

1459428 Pack of 25, Specify Color \$69.99 PACK

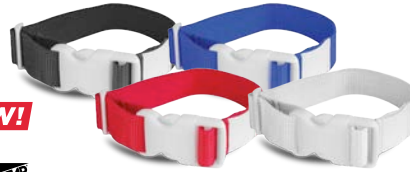

COACH'S CHOICE



LOCKER ROOM TOWELS (12-PACK)

- 100% cotton terry cloth

MSTOWELS 22"W x 44"L \$79.99 DZN ★



ELECTRONIC WHISTLE

- 4-switch, three tone functions- Off/Tone 1/Tone 2/Tone 3
- Sound can be aimed in specific directions
- Includes detachable wrist lanyard and 9-volt battery
- Instead of being mouth-operated, the Fox 40 electronic whistle, utilizes a push button feature for multiple operators to use

1459013 \$29.99 EA



PORTABLE SIGNAL HORN

- Offers a loud sound with a long lasting 8 oz. canister
- Push-button style, high-impact construction
- CANNOT BE SHIPPED BY AIR

MSAIR8ZH 8 oz. Refill \$38.99 EA
MSAIR8ZR \$24.99 EA

CLASSIC

- Revolutionary design allows for 3 aerodynamic wind chambers to deliver a sharp, clear tone with less effort
- No cork ball to stick or deteriorate
- Unaffected by moisture
- Extremely loud, recommended for official use only

MSWHIFOX 1240368

Fox 40 Classic \$9.99 EA
With Mouth Grip \$9.99 EA



LANYARDS

- 100% nylon lanyard with clamp and swivel
 - Must order 12 per color
 - Whistles not included
- Color Options: Gold, Kelly, Royal, Scarlet, White, Black, Maroon, Color My Class.

MSLNYD Select Color \$14.99 DZN ★
1392970 Color My Class \$14.99 DZN ★

LAUNDRY BAGS

- White nylon mesh bag with drawstring

MSLB1824 18" x 24" \$12.99 EA ★
MSLB2436 24" x 36" \$14.99 EA ★



DELUXE LAUNDRY BAG

- Heavy duty 100% polyester mesh
 - Cotton ID flag for player name or number marking
 - Rubber closure attached
- Color Options: Black, Gold, Royal, Scarlet, White.

1197327 Laundry Bag - 18" x 24" \$15.99 EA ★
1240214 Red Rubber Closure \$4.99 EA ★



MINI MEGAPHONE

- 300 yard range - 8 watts of power
- Trigger controlled; adjustable volume control; siren button
- High impact plastic with carrying strap
- Built-in microphone
- Operates on (6) AA batteries (not included)

MSMEG22W \$129.99 EA ★



LONG RANGE MEGAPHONES

- 1000 yard range - 25 watts of power
- Adjustable volume control
- Siren button
- High impact PVC construction
- Operates on (8) C batteries (not included)
- Weight: 7 lbs.

MSMEG61W Hand Held Mic \$329.99 EA ★
MSMEG51W Built-in Trigger Mic \$219.99 EA ★





WIRELESS CONTROLLER



OPTIONAL STAND
(SOLD SEPARATELY)

MacGregor

4' X 2' MULTISPORT INDOOR SCOREBOARD

- 6" LED numerals with 3 digit scoring, digital periods, bonus and possession indicators, (fouls can be kept on controller) last minute counts down in 1/10th seconds
- Durable plastic cabinet with plexiglass face
- Scores basketball, volleyball, wrestling and can function as a stopwatch or clock
- Includes rechargeable wireless remote control with 300' range and 12 frequency settings to help eliminate wireless interference
- Controller changes sports easily and can turn scoreboard on and off remotely
- Built in wall mount slots or use with portable stand (sold separately)
- Includes 100' of data cable if cable connection is preferred
- Weight: 24 lbs.
- Assembled stand measures 60"H x 56"W x 31"D

\$1,599⁹⁹

SK3048 ★ Complete Unit

OPTIONS		
1317107	Optional Stand	\$519 ⁹⁹ EA ★
1375095	Replacement Remote	\$449 ⁹⁹ EA ★



MacGregor

COUNT UP/DOWN CLOCK

- 4" LED numbers
- Timer counts up or down to 99:59
- 120 a/c power with 8 hour rechargeable battery
- Perfect device designed for any timed activities in your P.E. or Athletic program
- Built in control on top of timer with horn

1126631	6"H x 13"W x 4"D	\$429 ⁹⁹ EA ★
1139730	Replacement Battery	\$74 ⁹⁹ EA ★



LED BASKETBALL POSSESSION INDICATOR

- Bright, 10,000 hour LED lights
- Toggle switch operation
- Includes 15' cord for AC operation
- Built in rechargeable battery with 4 - 6 hour battery life
- Weight: 5 lbs.

1162639	5"H x 20"W x 2"D	\$219 ⁹⁹ EA ★
----------------	------------------	--------------------------



BUDGET POSSESSION INDICATOR

- Rigid plastic triangular design with arrow
- Simply turn to indicate possession
- Weight: 1 lb.

K30607		\$39 ⁹⁹ EA ★
---------------	--	-------------------------



PORTABLE MANUAL SCOREKEEPER

- 6" score digits
- 2.5" Period/Games digit up to 5
- Scores game up to 99 for each side
- No assembly required
- Lays flat for storage

1196177	11"H x 23"W	\$89 ⁹⁹ EA ★
----------------	-------------	-------------------------



MANUAL TABLETOP DOUBLE SIDED SCOREBOARD

- 6" numbers for scoring
- 2.5" numbers to score games (0-5 for each side)
- Scores up to 30 for each team
- Double-sided, see the score from front and back
- Folds up for easy transport and storage

MSMLTSCR	7"H x 15"W	\$99 ⁹⁹ EA ★
-----------------	------------	-------------------------

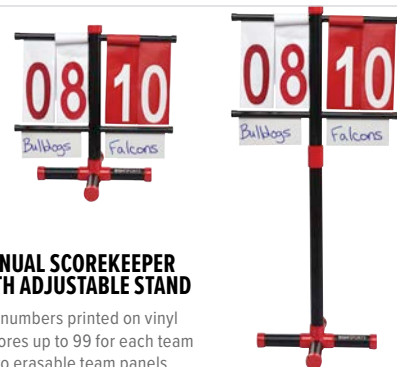

MANUAL SCOREKEEPER WITH ADJUSTABLE STAND

- 7" numbers printed on vinyl
- Scores up to 99 for each team
- Two erasable team panels
- PVC stand measures 38"H with a 15" x 15" base
- Converts from floor model to 12"H table top unit

1162448		\$119 ⁹⁹ EA ★
----------------	--	--------------------------

INDOOR TABLETOP SCOREBOARD



- Dimensions: 16"H x 24"W x 10"D - 13 lbs.
- LED clock digits: 4.75", LED score digits: 4.25"
- Scores basketball, volleyball and wrestling and can function as a metronome, stopwatch, clock with alarm and program timer
- Included wireless remote (100' range) allows operator to change score and start/stop the clock
- 4 user-programmable frequency settings for operating multiple units independently in the same area
- Includes digital periods, bonus, team fouls and possession indicators
- Indoor use only
- Optional assembled stand measures 43"H x 28"W x 28"D

SK2229R Indoor Tabletop Scoreboard **\$719⁹⁹** EA ★



BUILT IN CONTROL PANEL

OPTIONS

1293784	Wheeled Stand	\$179⁹⁹ EA ★
1240597	Extra Loud Horn	\$74⁹⁹ EA ★
1142266	Carry Bag	\$129⁹⁹ EA ★
1201789	Replacement Remote	\$61⁹⁹ EA ★
1167443	Replacement Power Cord/Adaptor	\$34⁹⁹ EA ★



BUILT IN CONTROL PANEL



SEGMENT TIMER W/WIRELESS REMOTE

- 8" and 13" super-bright, LED numerals (300' viewing distance)
- Program your practice schedule and workout drills
- All steel cabinet with built in handle, weather protector, fence attachment and storage pouch for remote programmer
- AC or DC with built-in, 8 hour rechargeable battery
- 140 decibel horn sounds after each segment, 3 short beeps after each rest period
- Program up to 99 segments from 1 second to 99 minutes. The last minute always counts down in seconds
- Wireless remote remembers last entry and has a range of 65 feet
- Not water proof - do not leave outside when not in use
- Weight: 26 lbs.

1239645	Segment Timer	\$2,499⁹⁹ EA ★
1239652	Replacement Wireless Remote	\$109⁹⁹ EA ★
1171570	Replacement Battery	\$64⁹⁹ EA ★

INDOOR/OUTDOOR TABLETOP SCOREBOARD

Same as our popular SK2229R tabletop scoreboard with the following added features:

- Dimensions: 16"H x 24"W x 10"D - 24 lbs.
- Dual LED setting for indoor and outdoor brightness
- AC/DC, with built-in rechargeable battery (up to 6 hour battery life depending on brightness setting)
- Portable use only (do not store outside or use during inclement weather)
- Assembled stand measures 43"H x 28"W x 28"D

1240580 Tabletop Scoreboard **\$899⁹⁹** EA ★

OPTIONS		
1293784	Wheeled Stand	\$179⁹⁹ EA ★
1240597	Extra Loud Horn	\$74⁹⁹ EA ★
1142266	Carry Bag	\$129⁹⁹ EA ★
1201789	Replacement Remote	\$61⁹⁹ EA ★
1167443	Replacement Power Cord/Adaptor	\$34⁹⁹ EA ★
1171570	Replacement Battery	\$64⁹⁹ EA ★

WIRELESS SHOTCLOCKS & CONTROLLER

Module included for use with the SK2229R or SK999 scoreboards.

- Dimensions: 20"H x 15"W x 7"D - 12 lbs. ea
- 8" LED shot clock digits (300' viewing distance) 4.7" game clock digits
- Power supplied by built-in rechargeable batteries or 110v AC power cord
- Built in horns
- Assembled stand measures 48"H x 16"W x 26"D
- Intended for indoor use only
- Optional stand not included

1171525 **\$1,249⁹⁹** SET ★

OPTIONS		
1171556	Optional Stand	\$169⁹⁹ EA ★
1167443	Replacement Power Cord/Adaptor	\$34⁹⁹ EA ★
1171570	Replacement Battery	\$64⁹⁹ EA ★

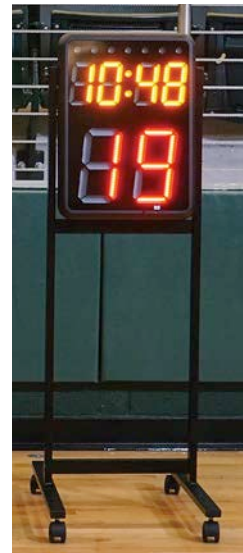

WIRELESS REMOTE



MONSTER BALL CART

- Fabricated from 1" square steel
- Black powder coated finish
- Holds 15 official size basketballs

1 Year Limited Warranty

1162608 30"H x 49"W x 20"D - 30 lbs. **\$499⁹⁹** EA ★



DOUBLE MONSTER BALL CART

- Fabricated from 1" square steel
- Black powder coated finish
- Holds 30 official size basketballs

1 Year Limited Warranty

1162615 30"H x 49"W x 24"D - 54 lbs. **\$699⁹⁹** EA ★



DOUBLE-WIDE BALL CART

- Made of 1" rugged chrome steel
- Holds 30 full size basketballs
- Comes with heavy duty swiveled rubber casters

1237634 33"H x 45"W x 24"D - 35 lbs. **\$449⁹⁹** EA ★



15 BALL CART

- Heavy duty chrome steel rods
- Solid triangular frames for strength and stability
- Non-marring casters
- Wide base design prevents tip over
- Holds 15 official size basketballs

1159639 38"H x 51"W x 19"D - 10 lbs. **\$184⁹⁹** EA ★



HEAVY-DUTY BALL CARTS

- Welded 1" square wall tubing with 3/4" steel chrome plated, ball support arms
- Non-marring, high quality 360° swivel casters
- Extra wide wheel base avoids tipping
- Add a school or mascot name, up to (10) letters, to the end panels (lettering sold separately and is not applied by manufacturer)

5 Year Limited Warranty

Color Options: **Grey, Royal Blue, Scarlet, White.**

1048452	12 Ball Cart	\$649⁹⁹ EA
1048490	18 Ball Cart	\$699⁹⁹ EA
1245899	Lettering	\$129⁹⁹ EA



**4-ROW
16 BALLS**



**3-ROW
12 BALLS**

WIDE BODY BALL CARTS

- Heavy duty white powder coated steel tubing
- Non-marring, hard rubber casters with a wide, no-tumble base
- Designed for easy storage and removal of balls
- 12 Ball Cart - 40"W x 40"H x 16"D
- 16 Ball Cart - 40"W x 52"H x 16"D

BCART12W	3 Row, 12 Balls	\$119⁹⁹ EA ★
BCART16W	4 Row, 16 Balls	\$149⁹⁹ EA ★



WALL MOUNT BALL RACK

- Black powder coated 1" steel tubing construction
- Easy to install with 4 screws (not included)
- Will hold up to 18 balls on 3 levels

1197739 40"H x 60"W x 15"D - 18 lbs. **\$229⁹⁹** EA ★



DOUBLE-SIDED BALL LOCKER

- Heavy duty 1" powder coated steel outside frame
- 5mm PVC coated steel mesh
- Allows for divided storage of balls
- Each side can be locked (locks not included)
- Holds up to 30 basketballs or volleyballs
- 8" back wheels allow for easy movement
- Fits through a standard doorway

1237627 44"H x 63"W x 24"D - 60 lbs. **\$529⁹⁹** EA ★



E-Z FOLD CART

- Aluminum square frame
- Nylon top with mesh bottom
- Holds 20 basketballs or 30 volleyballs
- Non-marring swivel casters
- Folds to only 6" wide for easy storage

MCVBCARTY 40"H x 24"W x 24"D **\$199⁹⁹** EA ★



STANDARD PORTABLE BALL LOCKER

- 1" steel tubing frame
- Holds up to 20 basketballs
- Hinged cover can be locked (lock not included)

12002100 43"H x 41"W x 24"D - 35 lbs. **\$499⁹⁹** EA ★



WALL MOUNTED BALL LOCKERS

- Constructed of 1" black powder coated steel tubing
- Permanently mounts to your gym wall (hardware not included)
- Holds 6 basketballs; Double model holds 16 basketballs or 30 volleyballs
- Double model includes locking bars at the top and bottom to secure balls (locks sold separately)

1173123 66"H x 15"W x 12"D **\$319⁹⁹** EA ★
1162578 66"H x 37"W x 12"D **\$399⁹⁹** EA ★



50 BALL CART

- Constructed of 1" O.D. black powder coated steel tubing
- Heavy duty urethane swivel wheels - 2 with brakes
- 5 welded shelves make for easy assembly
- Will hold 50 official size basketballs
- Fits through standard doorways

1378673 64"H x 24"W x 61"L - 61 lbs. **\$629⁹⁹** EA ★



COMPACT BALL LOCKER

- Constructed of 1" powder coated steel tubing
- Holds up to 30 inflated balls
- Can be padlocked (lock not included)
- Larger rear wheels roll smoothly over rough terrain
- Includes mesh ball bag

1362605 46"H x 26"W x 28"D - 42 lbs. **\$329⁹⁹** EA ★



ALL-TERRAIN BALL LOCKER

- 7/8" steel tubing frame w/ red powder coated finish
- Durable, welded wire mesh body
- Can be padlocked (lock not included)
- Heavy duty, 16" poly spoked wheels on rear
- 4" swivel casters on front
- Holds 15 official basketballs or 25 volleyballs

2 Year Limited Warranty
1342758 38"H x 46"W x 30"D - 50 lbs. **\$649⁹⁹** EA ★



DELUXE PORTABLE BALL LOCKER

- Constructed of 3/4" powder coated steel tubing
- Lockable, hinged cover (lock not included)
- Heavy duty multi-directional wheels

STBALLOC 40"H x 40"W x 26"D - 50 lbs. **\$499⁹⁹** EA ★



MONSTER BALL LOCKER

- Constructed of 1" powder coated steel tubing
- Holds 30 official basketballs or 40 volleyballs
- Features over sized 4" wheels for easy movement
- The top is lockable (lock not included) and contains special hinges and safety chains to prevent top from falling over

1162622 37"H x 47"W x 24"D - 75 lbs. **\$999⁹⁹** EA ★



BATTING PRACTICE BALL CART

- Constructed of 1.5" O.D. powder coated steel
- Large capacity basket
- Oversized "no flat" tires

1378683	Batting Practice Ball Cart	\$399 ⁹⁹ EA ★
1375102	Replacement Wheel	\$49 ⁹⁹ EA ★



DELUXE TEACHING CART

- Powder coated steel frame, vinyl coated basket with foam grip
- Rubber 4" wheels with sealed ball bearings
- Locking lid that lays flat against the side
- Includes basket hanger and convenient water bottle holder
- Holds 325 tennis balls
- Basket Height - 42 1/2"H
- Top Basket - 19" W x 23"L

1342550		\$479 ⁹⁹ EA ★
----------------	--	--------------------------



CONE CART

- Holds (60) 12" pvc or (200) plastic cones
- 1" diameter steel tube frame w/ silver powder coated finish
- 10" semi pneumatic wheels with roller bearings

1362619	45"H x 26"W x 16"D - 30 lbs.	\$299 ⁹⁹ EA ★
----------------	------------------------------	--------------------------



LARGE EQUIPMENT CART

- Safe, secure, highly visible wire storage center
- 2" square grid, nickel chrome finish
- Double door opens a full 270° and is lockable
- Comes with (4) 5" polyurethane swivel casters
- Interior shelves sold separately
- Assembly required - 1000 lb. capacity

92448XXX	69"H x 50"W x 26"D	\$1,284 ⁹⁹ EA	
92449XXX	Shelf 48"W x 24"D	\$139 ⁹⁹ EA	



COLOSSAL VOLLEYBALL CART

- Nylon basket includes side pockets for storage
- Holds 40 volleyballs
- Black only

1274417	38"H x 42"W x 32"D	\$279 ⁹⁹ EA
----------------	--------------------	------------------------



RACQUET CART

- Galvanized steel construction
- Holds up to 64 tennis rackets or 100 table tennis paddles
- Non-marring casters for easy transport

1690XXX	32"L x 14"W x 28"H	\$129 ⁹⁹ EA ★
----------------	--------------------	--------------------------



MULTI-PURPOSE EQUIPMENT WAGON

- All steel construction with pneumatic tires
- Use for carrying equipment, water containers, or field storage
- Front, rear, and side panels fold away for easy loading/unloading
- 1400 lb. weight capacity

1291766	11"H (sides) x 24"W x 48"L	\$599 ⁹⁹ EA ★
----------------	----------------------------	--------------------------



SCOOTER BOARD/CONE CART

- 1" diameter, powder coated silver, steel tubing
- Holds up to (28) 12" scooters with or without handles
- Large 10" rubber wheels
- Stores and transports game cones too

1375089	47"H x 32"W x 19"D	\$299 ⁹⁹ EA ★
----------------	--------------------	--------------------------



MULTI-PURPOSE EQUIPMENT CART

- Constructed of 1" powder coated steel tubing
- Great for carrying PE and baseball equipment
- Polyester bag measures 24"H x 24"W x 12"D

1197655	46"H x 29"W x 30"D - 29 lbs.	\$499 ⁹⁹ EA ★
----------------	------------------------------	--------------------------



BULK STORAGE CART

- Transport most anything in this heavy-duty PVC cart
- Durable plastic bottom board will hold laundry, balls or equipment
- Rolls easily

1366522 17"H x 47"W x 23"D - 47 lbs. \$449⁹⁹ EA



P.E. RECESS CART

- Store and transport equipment and balls frequently used during recess
- Holds up to (30) basketballs, soccer balls, 8.5" playground balls or volleyballs
- Also holds (100) jump ropes and (50) hoops of various sizes

1188318 60"H x 63"W x 19"D \$549⁹⁹ EA ★

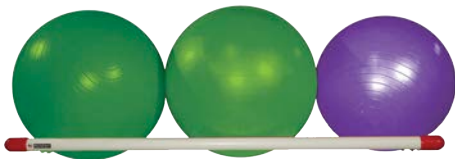

STABILITY BALL WALL RACK

- Wall-mounted stability ball rack (hardware not included)
- Conveniently holds 3 medium or 2 large fitness balls

1369556 55"W x 18"D - 6 lbs. \$129⁹⁹ EA

STABILITY BALL CART

- Stores and safely transports stability balls with a diameter of 16" or larger, plus jump ropes, exercise bands and resistance tubes
- Lightweight PVC, yet strong, durable and maintenance free
- Roll lock casters secure cart in place with the push of a lever
- Easily passes through a standard doorway



1257557 67"H x 67"W x 19"D \$679⁹⁹ EA 

JUMP ROPE/HOOP RACK

- Stores and transports over 120 jump ropes (up to 10' long) plus hoops
- Large base for increased stability
- Bar heights of 56", 62" and 68" allow children and adults to easily access the correct size jump rope
- Easily goes through standard doorway



1188325 68"H x 27"L x 19"D \$399⁹⁹ EA



LARGE LAUNDRY CARTS

- Bag is constructed of heavy duty canvas and removes easily with hook and loop fasteners
- Chrome plated steel frame
- Load capacity: 7 bushels, 51 gallons, 100 lbs.
- Support bars under bag
- 2½" casters, two with brake and 4 caster bumpers
- Outer dimensions: 36½"H x 38½"W x 24¾"D
- Inner dimensions: 23"H x 30½"W x 19½"D
- Assembly required

Lifetime Warranty

1. 1378279 Single Compartment \$299⁹⁹ EA
 2. 1378280 Divided Compartments \$299⁹⁹ EA



SHIELD DELUXE STORAGE BINS WITH LIDS

- Made from high density polyethylene
- 16 gallon bin, holds over 100 lbs
- Use indoors or outdoors
- Stackable design
- Built-in rounded handles and drainage holes
- Great for stations and color-coded activities
- 15.75" W x 18.75" L x 15.5" H
- Color My Class set includes 6 bins and 6 lids in each color; Blue, Green, Orange, Purple, Red and Yellow

90 Day Limited Warranty

1453546 \$389⁹⁹ SET



FITNESS STEP CART

- Large capacity storage rack and transporter for fitness steps and resistance tubes
- Lightweight and durable
- This cart will safely store up to (32) 4" steps or (16) 6" steps plus resistance tubes
- Features include heavy-duty, ball bearing, swivel, non-marring casters with a roll lock feature
- Easily goes through standard doorway

1188332 60"H x 45"W x 19"D \$549⁹⁹ EA



MULTI-TERRAIN ALL PLAY CART

- Large rubber wheels on back
- Non-marring swivel, locking casters on front
- Cart will transport up to (24) soccer balls or basketballs plus jump ropes, hoops and more
- Includes (2) heavy-duty baskets
- Easily goes through standard doorway

1257526 65"H x 52"W x 24"D \$699⁹⁹ EA



STIGA

STS185 TABLE

- 3/4" tournament blue top with silk screen lines
- 2" self opening steel legs
- 2" powder coated, steel apron with ball storage and corner protectors
- 3" mag wheels with sports tread tires, single sided swing arms and 2 locking wheels
- 72" pivoting net and post system with tension adjustments is integrated into the table to allow opening and closing without removing net
- Folds for playback and storage

1375127

\$799⁹⁹ EA



STIGA

STS520 TABLE

- 1" tournament blue top with silk screen lines
- 2 1/2" self opening, heavy duty steel legs with leg levelers and welded cross brace
- 2 1/2" powder coated, steel apron with full length ball storage and corner protectors
- 5" mag wheels with sports tread tires, single sided swing arms and 2 locking wheels
- 72" premium net and post system with tension adjustment and spring clip mounting
- Features an extra heavy-duty Euro design chassis for unmatched support
- Folds for playback and storage

1375131

\$1,449⁹⁹ EA



STIGA

STIGA® LEGACY INDOOR TABLE TENNIS TABLE

- 1/2" Black Top
- 1-1/2" Steel Apron
- 1-1/4" Steel Legs
- 2" Double Wheel Casters
- Self-Opening Legs
- Wooden Bottom Board, Cross Brace
- Corner Protection Pads
- Net and Posts Included

1308303

\$499⁹⁹ EA



TOURNAMENT BALLS

- Seamless ball for championship play
- 3-star - 40mm - White

1035612

\$69⁹⁹ BOX OF 6 ★

RECREATIONAL BALLS

- Durable, all around ball
- 1-star - 40mm - White

1035605

\$2⁴⁹ BOX OF 6 ★

1071177

\$44⁹⁹ GROSS OF 144 ★

STIGA DELUXE BALLS

- Top quality game ball
- 2-star - 40mm - White

918XXXXX

\$89⁹⁹ GROSS OF 144



PADDLES

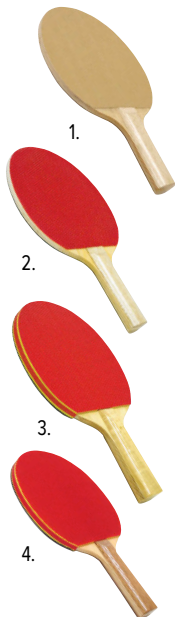

1. ECONOMY SAND PAPER FACE

- Sand paper face

NAS1XXXX

5 ply

\$6⁹⁹ EA ★

2. ECONOMY RUBBER FACE

- Pips out face

NAR1XXXX

5 ply

\$7⁹⁹ EA ★

3. STANDARD SPONGE RUBBER 2MM

- Pips out face and tapered edging

NAR2XXXX

5 ply

\$10⁹⁹ EA ★

4. DELUXE SPONGE RUBBER 2MM

- Pips in face and tapered edging

NAF2XXXX

5 ply

\$13⁹⁹ EA ★

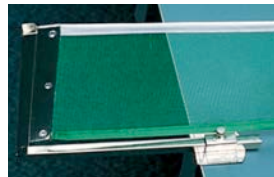

CHAMPIONSHIP NET AND POST SET

- Slip on, heavy-duty, open mesh polyethylene net (72" long)
- Heavy-duty posts with extended net clamps

NANP3XXX

\$44⁹⁹ SET ★



STIGA

PREMIUM CLIPPER & NET POST SET

- Tournament-level table tennis net and post set
- 72" premium cotton blend net and heavy-duty steel post
- Easy set-up and removal with spring-activated clip
- Precise tension adjustment with height measuring tool for regulation play
- Fits regulation-size tables (60" wide) with up to 1" table thickness

30 Day Limited Warranty

1454852

\$69⁹⁹ SET



GLADIATOR FOOSBALL TABLE

- Tournament quality table that is built to last
- 15" deep MDF cabinet with 2" thick sidewalls
- 3/4" MDF playing surface
- 4 3/4" square post style legs with levelers
- 5/8" solid steel rods and traditional style men
- 34 3/4"H x 311/4"W x 56"L
- Includes 4 balls and integrated cup holders
- Weighs 180 lbs. - assembly required

1375117

\$859⁹⁹ EA 



FOOSBALL PLAYERS W/HARDWARE

- 6 players including attachment hardware
- 90 Day Limited Warranty**
- Color Options: **Black, Red.**

1375152

Specify Color

\$29⁹⁹ PACK OF 6



6 PACK OF FOOSBALLS

- Replacement foosballs
- 30 Day Limited Warranty**

1378324

\$21⁹⁹ PACK

SHUFFLEBOARD ACCESSORIES



SHUFFLEBOARD TABLE CLEANER & POLISH

- Removes dirt and produces high luster - 1 Qt.

NA7922XX

\$42⁹⁹ EA



SHUFFLEBOARD TABLE WEIGHTS

- 2" replacement weights
- 90 Day Limited Warranty**
- Color Options: **Blue, Red.**

1379364

Specify Color

\$17⁹⁹ EA

SHUFFLEBOARD TABLE



SHUFFLEBOARD TABLE

- Poly-Coated solid play surface for smooth, fast action
- Play area measures 14"W x 94 3/8"L
- Laminated cabinet and pedestal legs with levelers
- Abacus style scoring
- Includes 8 weights and 1 canister of wax
- Overall size: 31"H x 24 1/4"W x 108 1/4"L

1375124

220 lbs.

\$1,049⁹⁹ EA 



Mizerak

DONOVAN 8' POOL TABLE

- 3/4" playbed
- Reinforced pedestal style legs with leg levelers
- 3 5/8" Black laminate top rails
- Chrome corner posts and caps
- Full profile K66 cushions
- Deep Red wool/nylon blend cloth
- Internal drop pockets
- Includes 2 cues, 1 set of balls, 1 triangle, chalk and table brush
- 31 1/4"H x 55"W x 99"L
- Assembly required

1276497	Slate - 683 lbs.	\$2,249⁹⁹ EA	
1276503	Slatron - 331 lbs.	\$2,199⁹⁹ EA	



Mizerak

DAKOTA 8' POOL TABLE

- 3/4" playbed
- Reinforced pedestal style legs with leg levelers
- 3 5/8" laminate top rails with full profile K66 nose rubber - provide uniform rebound and consistent play
- Wool blend cloth
- Features an internal ball return system
- Includes 2 cues, 1 set of balls, 1 triangle, chalk and table brush
- 31 1/4"H x 55"W x 99"L
- Assembly required

1375150	Slate - 683 lbs.	\$2,849⁹⁹ EA	
1375151	Slatron - 331 lbs.	\$2,149⁹⁹ EA	



SOLID WOOD ONE-PIECE CUES

NAQ481XX	48"	\$29⁹⁹ EA ★
NAQ521XX	52"	\$31⁹⁹ EA ★

Size: 17 oz, 19 oz, 20 oz, 21 oz.

NAQ57117	57" - Specify Weight	\$27⁹⁹ EA ★
-----------------	----------------------	-------------------------------

Screw-In Pool Cue Tips

• For wood and aluminum cues

NASCRTIP	\$13⁹⁹ DZN ★
-----------------	--------------------------------



CHALK

NACHK122	\$9⁹⁹ BOX OF 12 ★
NACHK144	\$69⁹⁹ BOX OF 144 ★



Mizerak

MIZERAK SPIDER BRIDGE HEAD

- Provides 9 different shooting positions
- Slips onto any cue to convert to bridge cue
- Cues sold separately

90 Day Limited Warranty

1393111	\$19⁹⁹ EA
----------------	-----------------------------



CLASSIC BUMPER POOL TABLE

- 49 1/2" x 33 1/2" play field
- 5 1/8" square legs
- 5 7/8" top apron and 7 3/4" bottom apron
- Constructed of MDF with wood grain laminate
- Accessories Included: 1 set of bumper pool balls, 2 (48") cues, chalk and brush
- Overall Dimensions: 32"H x 41 1/2"W x 57 1/2"L
- Assembly required

1375121	274 lbs.	\$1,099⁹⁹ EA	
----------------	----------	--------------------------------	--



SPIKEBALL™

- Standard set includes one frame and three balls
- Rookie set includes one frame and one ball
- Rookie frame is 50% larger than standard frame
- Standard ball - 3.5" diameter, Rookie ball - 7" diameter

90 Day Limited Warranty

1376884	Standard Set	\$74 ⁹⁹ SET
1376885	2 Balls - standard size	\$12 ⁹⁹ SET
1453529	Rookie Set	\$64 ⁹⁹ EA



BAGGO BEAN BAG TOSS GAME

- Played similar to horseshoes
- Weighs only 20 lbs. and folds making it easy to carry and store (2 1/2"H x 20"W x 36"L)
- Constructed of high-impact polyethylene for lasting durability
- Take the two boards, spread them apart and begin to play
- Includes 2 game boards, eight 6" bean bags, a distance regulator, wall mounting bracket, and instruction booklet

1269000		\$152 ⁹⁹ SET
1269017	Replacement Bean Bags - 4 Red + 4 Blue	\$31 ⁹⁹ SET OF 8



STANDARD PLAYING CARDS

- Plastic coated, linen finish
- Packed per dozen
- Half Blue and half Red

NAPC-1XX	Poker	\$36 ⁹⁹ DZN ★
-----------------	-------	--------------------------



SCRABBLE

- Classic crossword game
- For 2 to 4 players ages 8 and up

4044XXXX		\$39 ⁹⁹ EA
-----------------	--	-----------------------

UNO CARD GAME

- Yell UNO! when you have only one card left
- America's #1 card game
- Includes 108 cards
- 2 to 10 players ages 7 and up



4036XXXX		\$13 ⁹⁹ EA
-----------------	--	-----------------------



YAHTZEE

- Throw the dice to build straights, full houses, 5 of a kind - Yahtzee
- For 1 or more players ages 8 and up

4024XXXX		\$21 ⁹⁹ EA
4025XXXX	80 Replacement Score Cards	\$9 ⁹⁹ EA

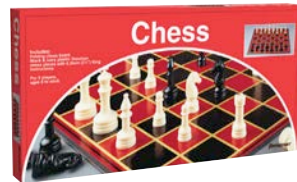

CHESS SET

- 15" x 15" folding board
- (32) plastic chess pieces

2261XXXX		\$10 ⁹⁹ SET
-----------------	--	------------------------



CHECKERS SET

- 15" x 15" folding board
- (24) 1 1/4" checkers

NA637XXX		\$9 ⁹⁹ EA
-----------------	--	----------------------

MORE BOARD GAMES TO CHOOSE FROM

GAME EDITIONS AND VERSIONS MAY VARY FROM THOSE SHOWN

DOMINOES SET WITH CASE	1238211	\$18 ⁹⁹ EA
MONOPOLY JUNIOR	4919XXXX	\$34 ⁹⁹ EA
ROOK	4714XXXX	\$12 ⁹⁹ EA
SCRABBLE DICTIONARY	4915XXXX	\$16 ⁹⁹ EA

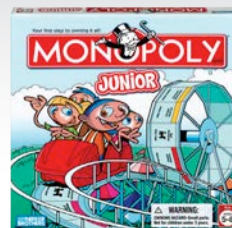

BEST SELLER

Voit



2-PLY PLAYGROUND BALLS!

PLAYGROUND BALLS

- The most widely used playground ball in the country!
- Please specify color where applicable

VP65HXXX	5"	Red Only	\$5.49 EA ★
VP66HXXX	6"	Blue, Green, Orange, Purple, Red, Yellow	\$5.99 EA ★
VP67HXXX	7"	Red Only	\$5.99 EA ★
VP685HXX	8 1/2"	Blue, Green, Orange, Purple, Red, Yellow	\$6.49 EA ★
VP610HXX	10"	Blue, Green, Orange, Purple, Red, Yellow	\$7.39 EA ★
VP613HXX	13"	Red Only	\$15.99 EA ★
VP616HXX	16"	Red Only	\$19.99 EA ★

PLAYGROUND BALLS

- The most widely used playground ball in the country
- 2-ply rubber ball for all low impact activities

1369484	6" - Color My Class	\$34.99 SET OF 6 ★
1033472	8 1/2" - Color My Class	\$41.99 SET OF 6 ★
1369485	10" - Color My Class	\$45.99 SET OF 6 ★

Voit
8 1/2" ENDURO SERIES
PLAYGROUND BALLS

- Our toughest most durable playground ball!
 - Nylon wound for more durability and shape retention
 - Designed to withstand all high-impact playground activities
- Color Options: **Blue, Green, Orange, Purple, Red, Yellow.**

154470	Specify Color	\$8.99 EA ★
1369483	Color My Class	\$49.99 SET OF 6 ★



OFFICIAL KICKBALL

- Official game ball of the World Adult Kickball Association
- Premium rubber cover (latex free)
- Classic red design with a diamond pattern
- Minimum of 5 balls per order

1387040	10" Diameter	\$18.99 EA
----------------	--------------	------------



MacGregor

MULTICOLOR BASKETBALLS

- Durable rubber construction
 - Deep channels and enhanced pebbling
 - Indoor/Outdoor use
 - Official size 29.5", Intermediate size 28.5", Junior 27.5", Colt 25.5", Mini 22"
- Color Options: **Blue, Green, Orange, Purple, Red, Yellow.**

936021	Official Size	\$16.99 EA ★
93600	Official - Color My Class	\$79.99 PACK OF 6 ★
935021	Intermediate Size	\$15.99 EA ★
93500	Intermediate - Color My Class	\$76.99 PACK OF 6 ★
934021	Junior Size	\$15.99 EA ★
93400	Junior - Color My Class	\$73.99 PACK OF 6 ★
1308099	Colt - Color My Class	\$61.99 PACK OF 6 ★
1268935	Mini - Color My Class	\$65.99 PACK OF 6 ★



MacGregor

MULTICOLOR SOCCERBALLS

- Top quality rubber construction
- Nylon windings and butyl bladder for superior strength and air-retention

94500	Size 5 - Color My Class	\$68.99 PACK OF 6 ★
MCSBR502	Size 5 - Blue	\$15.99 EA ★
94400	Size 4 - Color My Class	\$59.99 PACK OF 6 ★
MCSBR402	Size 4 - Blue	\$15.99 EA ★
94300	Size 3 - Color My Class	\$56.99 PACK OF 6 ★



MacGregor

MULTICOLOR FOOTBALLS

- Durable rubber construction
- Pebble grain exterior with raised laces for a superior grip
- Nylon windings and butyl bladder provides added strength and air-retention

95900	Official - Color My Class	\$76.99 PACK OF 6 ★
MCX2L25X	Official - Yellow	\$14.99 EA ★
95700	Youth - Color My Class	\$73.99 PACK OF 6 ★
95600	Junior - Color My Class	\$71.99 PACK OF 6 ★
MCX2J25X	Junior - Yellow	\$13.99 EA ★



TUFF FOAM BALL PACKAGE

Package includes:

- 6 Voit 8 1/4" "Special" Tuff balls
- 6 Voit 6 1/4" "Softi" Tuff balls
- 6 Voit 5" Mini Tuff balls
- 3 Voit 6 1/4" Tuff dodgeballs
- 3 Voit Tuff soccerballs - size 4

1179378 24 Pieces **\$419.99** SET ★



Voit



SOFT-LOW BOUNCE TUFF BALLS

- Our coated foam balls are soft, squeezable and built to last
- Durable enough for all playground and indoor games
- Builds confidence and enhances skill development
- Easy to catch, grip and control
- Tear-resistant cover is washable, non-toxic and can be disinfected

Color Options: **Blue, Green, Orange, Purple, Red, Yellow.**

44075	5" Mini Playball	\$16.99 EA ★
1181555	5" - Color My Class	\$79.99 SET OF 6 ★
440011	6 1/4" Softi	\$18.99 EA ★
1179286	6 1/4" - Color My Class	\$84.99 SET OF 6 ★
1369513	7" Seven	\$24.99 EA ★
1369579	7" - Color My Class	\$115.99 SET OF 6 ★
440101	8 1/4" Special	\$35.99 EA ★
1236149	8 1/4" - Color My Class	\$175.99 SET OF 6 ★



Voit

BOUNCEE FOAM BALLS

- High density coated foam balls are lively and bounce
- Use for teaching dribbling, kicking and bouncing lead up skills
- Tear-resistant cover is washable, non-toxic and can easily be disinfected
- Color My Class set includes one of each color: Blue, Green, Orange, Purple, Red and Yellow

1395254	6 1/4"	\$99.99 SET OF 6 ★
1395255	8 1/4"	\$199.99 SET OF 6 ★



Voit

6 1/4" NEON "SOFTI" TUFF BALLS

- Soft, squeezable coated foam balls in exciting bright colors
- Soft enough for indoor play and "tuff" enough for rugged playground activities
- Easy to catch, grip and control

1274967 **\$104.99** SET OF 6 ★



Voit

TUFF COATED FOAM FOOTBALLS

- Lightweight, yet heavy enough for quality football action
- Color Options: **Blue, Green, Orange, Purple, Red, Yellow.**

VFTBL10	Junior - 9 3/4"	\$28.99 EA ★
1243925	Junior - Color My Class	\$142.99 SET OF 6 ★
VTMNF891	Mini - 8 1/2"	\$27.99 EA ★
1243864	Mini - Color My Class	\$119.99 SET OF 6 ★



Voit

TUFF COATED FOAM SOCCER BALL

- Durable ball, perfect to learn lead-up skills
 - Features high-density foam covered in "tuff" vinyl
- Color Options: **Blue, Green, Orange, Purple, Red, Yellow.**

44017XXX	Size 4	\$36.99 EA ★
1243987	Size 4 - Color My Class	\$164.99 SET OF 6 ★
1369585	Size 5	\$39.99 EA ★
1369584	Size 5 - Color My Class	\$173.99 SET OF 6 ★



Voit

TUFF 6 1/4" DODGEBALL

- Soft, slow moving and easy to grip
- Soft, low density foam covered in a "Tuff" outer cover

44020	Black	\$19.99 EA ★
1369507	Color My Class	\$99.99 SET OF 6 ★

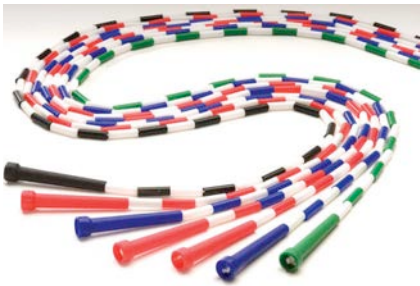

SEGMENTED SKIP ROPES

- Designed for use by all age groups and skill levels
- An economical way to promote mass participation
- Great for a fun, aerobic workout
- Features durable, plastic segments over a solid long-lasting nylon cord

1040142	6' Black/White	\$4 ⁹⁹ EA ★
1040159	7' Red/White	\$4 ⁹⁹ EA ★
1040166	8' Blue/White	\$4 ⁹⁹ EA ★
1040173	9' Red/White/Blue	\$5 ⁹⁹ EA ★
1040128	10' Red/White	\$6 ⁹⁹ EA ★
1040135	16' Green/White	\$6 ⁹⁹ EA ★



SPEED ROPES

- Poly rope with plastic swivel handle
- Speed, durability, and flexibility all in one rope

1040043	6'	\$4 ²⁵ EA ★
1040050	7'	\$4 ⁹⁹ EA ★
1040067	8'	\$5 ⁹⁹ EA ★
1040074	9'	\$5 ⁹⁹ EA ★
1040081	10'	\$5 ⁹⁹ EA ★
1040098	16'	\$6 ⁹⁹ EA ★



LICORICE ROPES

- Perfect for beginners or experienced jumpers who want the best
- Great for speed jumping and a favorite with jump teams
- Injection molded handles designed for comfort and free spin
- Durable, plastic rope

17206XXX	Black 6' Licorice	\$3 ⁹⁹ EA
17207XXX	Orange 7' Licorice	\$5 ⁹⁹ EA
17208XXX	Red 8' Licorice	\$5 ⁹⁹ EA
17209XXX	Green 9' Licorice	\$5 ⁹⁹ EA
17210XXX	Black 10' Licorice	\$6 ⁹⁹ EA



LOW PROFILE CONES

- Soft, flexible and stack easily
- Color code your drills for more effective practice time
- Available in Orange, Yellow, or Color My Class
- 3"H x 7 3/4" diameter
- Color My Class set includes 2 of each color: Blue, Green, Orange, Purple, Red and Yellow

1255706	Orange	\$19 ⁹⁹ DZN ★
1276558	Yellow	\$21 ⁹⁹ DZN ★
1255690	Color My Class	\$16 ⁹⁹ DZN ★



SPOT MARKERS

- 9" diameter, soft, flexible, plastic markers
- Stick to gym floors without shifting
- Color My Class pack includes either 1 or 2 of each color: Blue, Green, Orange, Purple, Red and Yellow

6058SPOT	Color My Class (12)	\$44 ⁹⁹ DZN ★
1309973	Color My Class (6)	\$23 ⁹⁹ SET OF 6 ★
6059XXX	Orange (12)	\$44 ⁹⁹ DZN ★



STANDARD HOOPS

- No P.E. or recreation program is complete without hoops
- Versatile hoops teach balance, coordination and rhythm
- Use as targets, jump and hop rings for races and much more
- Each dozen includes 2 of each color: Blue, Green, Orange, Purple, Red and Yellow

1246087	24" Diameter	\$65 ⁹⁹ DZN
1246070	30" Diameter	\$70 ⁹⁹ DZN
1274646	36" Diameter	\$75 ⁹⁹ DZN



5" NYLON BEAN BAGS

- Nylon bags are filled with synthetic filler
- Color My Class set includes two of each color

1293418	Color My Class	\$19 ⁹⁹ DZN ★
---------	----------------	--------------------------



ZOOMER SCOOTERZ

- 16" x 16" scooters with safety guards to protect hands and fingers
- Feature large 4", durable all-terrain, ball bearing wheels
- Tough for the playground and safe for gym floors
- Supports up to 175 lbs

1265293	Color My Class	\$399 ⁹⁹ SET OF 6 ★
1296082	Blue	\$74 ⁹⁹ EA ★
1389168	Replacement Wheels	\$30 ⁹⁹ SET OF 4 ★



TURBOSCOOTER™

- Non-Connecting scooters with safety hand guards
- Oversized 4" wheels for use outdoors and indoors
- Rugged enough to be used on concrete and asphalt

1363648	12" - Color My Class	\$357 ⁹⁹ SET OF 6
1363649	12" Blue	\$64 ⁹⁹ EA
1137408	16" - Color My Class	\$419 ⁹⁹ SET OF 6
1363650	16" Yellow	\$77 ⁹⁹ EA
1390055	Replacement Wheels	\$43 ⁹⁹ SET OF 4

DELUXE HOOPS

- Stronger than our standard hoops - thicker wall
- Set them up as targets for tossing, jump and hop rings for races or in your obstacle course
- Set of 12 includes 2 of each color: Blue, Green, Orange, Purple, Red and Yellow

1064902	24" Diameter	\$82 ⁹⁹ DZN
1064919	30" Diameter	\$87 ⁹⁹ DZN
1064926	36" Diameter	\$92 ⁹⁹ DZN

PREMIUM NO-KINK® HOOPS

- Regular hoops often become the object of tug-of-war
- Pulling causes a kink, and off to the hoop graveyard!
- Extra thick walls prevent kinking
- Includes 2 of each color: Blue, Green, Orange, Purple, Red and Yellow

02150XXX	24" Diameter	\$94 ⁹⁹ DZN
02160XXX	30" Diameter	\$99 ⁹⁹ DZN
02170XXX	36" Diameter	\$104 ⁹⁹ DZN



SPIKEBALL™

- Standard set includes one frame and three balls
- Rookie set includes one frame and one ball
- Rookie frame is 50% larger than standard frame
- Standard ball - 3.5" diameter, Rookie ball - 7" diameter

90 Day Limited Warranty

1376884	Standard Set	\$74⁹⁹ SET
1376885	2 Balls - standard size	\$12⁹⁹ SET
1453529	Rookie Set	\$64⁹⁹ EA



CROSSNET VOLLEYBALL

- Available in Volleyball, Soccer, Portable 4 square, and doubles net
- Volleyball Height adjustable for men (7'11"), women (7'4") & children (5'6")
- Volleyball includes ball, four-way net, and poles
- H2O includes our 4-way net, floating base, travel duffel bag, inflatable neoprene ball, and pump
- Soccer includes the net only
- 4 square includes straps and ball
- Easy setup and break down



1461854	CROSSNET Volleyball	\$119⁹⁹ EA
1461855	CROSSNET H2O	\$149⁹⁹ EA
1461856	Volleyball Doubles Net	\$74⁹⁹ EA
1461857	CROSSNET Soccer	\$179⁹⁹ EA
1461858	CROSSNET Portable 4 Square	\$54⁹⁹ EA

FLOORMARX™ SET

- Safe, smart, and easy way to instruct movement
- Quick to apply and easy to remove
- Fast drying ink (2min) and cleaning wipes (30 sec) pass safety slip tests
- One Floor Marker writes for over 250 yards (over 4 rolls of traditional floor tape)
- Set includes 2 Floor markers, 1 green and 1 blue, and 1 canister cleaning foot wipes
- Intended for sealed gymnasiums and dance floors, and other non-porous surfaces
- BEFORE FULL APPLICATION, always test on multiple, small, inconspicuous areas of the floor

1454864	\$49⁹⁹ SET
----------------	------------------------------



FLOORMARX H2O PERF. PACK

- Pack includes 5 markers (red, orange, green, blue, and purple), 1 canister of foot wipes, and 1 bag of R&R Foot Towels (20)

1461860	\$84⁹⁹ PACK
----------------	-------------------------------



ORANGE GAME CONES

- Flexible PVC with weighted base for added stability
- Stack easily for storage

1040814	12"	\$17⁹⁹ EA ★
1040838	18"	\$24⁹⁹ EA ★
1040845	28"	\$44⁹⁹ EA
1040852	36"	\$59⁹⁹ EA
1040852SET	36"	\$249⁹⁹ SET OF 5

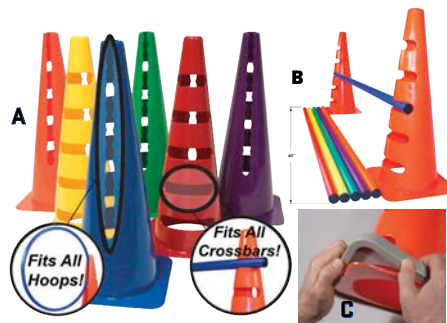

SLOTCONES™

- Optional slip on rubber bases adds more stability and lock-in crossbars pop in snugly creating hurdles of various heights
- Lock-In Crossbars and Weighted Bases sold separately
- SlotCones and crossbars include one of each color: Blue, Green, Orange, Purple, Red and Yellow

1453543	SlotCones	\$61⁹⁹ SET OF 6
1453544	Lock-In Crossbars	\$46⁹⁹ SET OF 6
1454870	Weighted Rubber Base	\$10⁹⁹ EA



GAME CONES

- Flexible, PVC cones with weighted bases for increased stability
- Use to designate boundaries, lanes and teams

1398265	28" - Color My Class	\$159⁹⁹ SET OF 6
1245875	18" - Color My Class	\$94⁹⁹ SET OF 6 ★
1093452	12" - Color My Class	\$59⁹⁹ SET OF 6 ★
MS6CONPK	6" - Color My Class	\$34⁹⁹ SET OF 6 ★



OUTDOOR TETHERBALL POLE

- 12'L (2 pieces 6'L) 2 3/8" galvanized steel post installs permanently into the ground 2'
- Permanent top eye and ball included

THBIG \$299⁹⁹ EA ★



DISC GOLF DISCATCHER®

- Galvanized steel construction with HD welds
- 28 chain grid design
- Powder coated stainless steel chain rack with vinyl numbers
- Anti-skip basket rim prevents skips
- PDGA approved

MDCI	In-Ground/Permanent	\$699 ⁹⁹ EA
MDCP	Portable w/Base	\$699 ⁹⁹ EA



1.

2.

TETHERBALLS

- Both balls feature nylon windings and a butyl bladder for added shape and air retention
- Choose between a soft touch cover for added comfort or a traditional rubber cover
- Includes an attached recessed rope

1. VCT850HS	Soft Touch Cover	\$22 ⁹⁹ EA ★
2. VCT850HX	Rubber Cover	\$18 ⁹⁹ EA ★



6" SLASH-PROOF SWING SEAT

- Synthetic rubber seat with a metal insert for increased durability
- For ages 5-12

6152DXXX \$65⁹⁹ EA ★



ULTIMATE FRISBEE® DISC

- Meets the specifications for the sport of Ultimate
- UPA approved - 175 grams and 10 1/2" diameter
- Colors and graphics may vary

30 Day Limited Warranty

1268942 \$15⁹⁹ EA



WHAM-O® FRISBEE® DISC

- The original Frisbee®
- 3 weights and diameters to choose from
- Color and graphics may vary

1308822	10 1/4" Diameter - 160 Grams	\$14 ⁹⁹ EA
1308839	11" Diameter - 200 Grams	\$15 ⁹⁹ EA

ORIGINAL PILLO POLO® GAME

HOW THE GAME IS PLAYED:

- Played similar to ice hockey rules, except the goalie is allowed to pick up the ball and throw it down field
- No. Players: 12 plus substitutes
- Age Levels: 7 years and up
- Space Required: 50' x 100'
- Supervision Required: 1 Referee
- Average Activity Time: 30 - 60 min.
- Sticks are lightweight yet durable - tough outer skin over urethane foam heads that resist peeling and flexible plastic shafts

HIGH PERFORMANCE STICKS.
MADE OF SOFT DURABLE FOAM!



COMPLETE PILLO POLO® GAME

- 6 Blue and 6 Yellow sticks 31" long, two 7" foam balls, set of official rules
- Goals, cones and bag not included

1041170 \$194⁹⁹ SET ★



ACCESSORIES

EXTRA PILLO POLO® STICKS

Replacement sticks to go with Pillo Polo® game (1041170).

Color Options: **Yellow, Blue.**

601XXXXX Extra Pillo Polo® Sticks \$23⁹⁹ EA ★

6" GAME CONES

Color Options: **Blue, Orange, Purple, Red, Yellow, Green.**

MS6CONPK \$34⁹⁹ SET OF 6 ★

STORAGE BAG

Color Options: **Black, Blue, Gold, Kelly, Orange, Purple, Red.**

SNBCNET \$17⁹⁹ EA ★

EXTRA 7" FOAM BALL

607XXXXXY \$17⁹⁹ EA ★

PILLO POLO GOAL

• 44"H x 54"W x 30"D steel goal

1343113 \$124⁹⁹ EA

3.0 TOURNAMENT NET & FRAME

- Portable, regulation-size pickleball 3.0 Tournament Net
- Comes with a high-strength 22' steel snap-together frame, lightweight net and instructions on how to set-up and play, all in a sturdy carry bag

90 Day Limited Warranty

1450232 \$229⁹⁹ EA



3.0 TOURNAMENT NET & FRAME SET WITH DILLER WOOD PADDLES

- This tournament set includes everything you need to get started playing pickleball
- Includes portable, regulation-size metal frame, net, 4 Diller paddles, 4 pickleballs, nylon carrying bag and rules/strategy guide

90 Day Limited Warranty

1364661

\$299⁹⁹ SET



DILLER PADDLE & BALL PACK

- The Ultimate Starter Kits!
- Durable maple wood pickleball paddles with wrapped grip, safety strap and pickleballs

1450226 2 Paddles + 4 Balls \$32⁹⁹ PACK

1450227 4 Paddles + 4 Balls \$55⁹⁹ PACK

DILLER PADDLE

- Lightweight 7-ply maple wood paddle with wrapped handle and safety wrist strap
- From the company that invented the game
- A top choice for recreational and institutional play

1450225 \$19⁹⁹ EA



47" ALUMINATOR® HOCKEY SET

- Strong aluminum shafts and reinforced plastic blades
- Great grip improves stick handling
- Includes: 12 sticks, 2 hotballs, 2 soft shot pucks, 2 replacement blades and instructions

10577XXX	47" Stick Set	\$411 ⁹⁹ SET
8853	Replacement 47" Aluminum Stick, Red or Blue	\$44 ⁹⁹ EA
894	Replacement Blades Red or Blue Set of 3	\$24 ⁹⁹ SET OF 3
20026517	40" Goalie Stick, Aluminum Shaft	\$33 ⁹⁹ EA



HOCKEY GOAL - STEEL

- 4' x 6' goal to be used indoors or outdoors for soccer, hockey, floor hockey or many other uses
- 3mm net with nylon sleeves
- 1 5/8" O.D. galvanized steel tubing and assembled with galvanized steel fittings; equipped rubber footings for indoor use
- Weight: 44 lbs.

1298857 4'H x 6'W x 18"D \$549⁹⁹ EA ★

1162400 Replacement Net \$109⁹⁹ EA ★

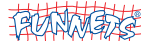

HOCKEY GOAL - ABS

- 4' x 6' goal to be used indoors or outdoors for soccer, hockey, floor hockey or many other uses.
- 3mm net with nylon sleeves
- 1 5/8" O.D. Sportstuff rods and assembled with ABS fittings
- Weight: 18 lbs.

1249088 4'H x 6'W x 18"D \$279⁹⁹ EA ★

1162400 Replacement Net \$109⁹⁹ EA ★

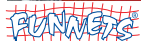

LIFETIME GUARANTEE ON SHAFTS!



LTG 50" HIGH SCHOOL/COLLEGIATE HOCKEY SETS

- LTG shafts guaranteed for life!
- Tough, black, plastic shaft with a lightweight, solid, fiberglass, rod
- Set includes: 10 LTG sticks, 2 ABS goalie sticks, 2 speed control balls and instructions
- Indoor sticks have red and blue blades
- Outdoor sticks have black and white blades
- Made in the USA

1304213 Indoor Set \$378⁹⁹ SET

1304220 Outdoor Set \$394⁹⁹ SET



CROSS SECTION



E-Z TARGET

- Finally a good quality, economical foam target for institutional use
- 36" square and 3 1/2" thick
- Comes complete with stand and paper target face
- Lightweight for easy set up and take down
- For bows up to 40 lbs.

30 Day Limited Warranty

1308563 **\$99⁹⁹** EA



ETHAFOAM TARGETS WITH REPLACEABLE CORE

- Used at many of the finest camp and school archery programs
- Features an 18" replaceable core
- 6" thick foam is weather/insect proof with self healing tendency
- Target stand sold separately
- Target face included

1375654	36" Square	\$349⁹⁹ EA ★
1375655	36" Round	\$369⁹⁹ EA ★
1375656	48" Square	\$479⁹⁹ EA ★
1375657	48" Round	\$499⁹⁹ EA ★
ARCORE	18" Replacement Cores - Fits 36" and 48"	\$349⁹⁹ SET OF 3 ★



FREE STANDING ROLLED FOAM TARGET

- Features "Rolled Heat Bond" - foam strips laminated under heat and pressure
- No stand needed because bottom is flat
- 36" tall and 12" thick
- Built-in carry handle
- 4 color hang on face included

NECAS36 36" - 30 lbs. **\$399⁹⁹** EA



POWERLIGHT TARGET

- High density foam for maximum durability
- Twice the life of normal recreational targets
- Accepts up to 70 lb. draw weight bows
- Easy arrow removal

1394269	36" - 35 lbs.	\$389⁹⁹ EA
1394270	48" - 50 lbs.	\$599⁹⁹ EA S&H

CAN BE USED WITH BOWS UP TO 70LBS.



ROLLED FOAM TARGET

- Lighter weight for easy set up and storage
- Features "Rolled Heat Bond" - foam strips laminated under heat and pressure
- Available in 36" and 48" diameters
- Approximately 7" thick
- Target face included

NECA236X	36" - 15 lbs.	\$289⁹⁹ EA
NECA248X	48" - 30 lbs.	\$399⁹⁹ EA



TARGET STANDS

- Holds 36" and 48" targets

3718XXXX	Wheeled Stand	\$189⁹⁹ EA ★
1197761	Tripod Stand	\$99⁹⁹ EA ★



MONSTER TARGET STAND

- Adjustable - holds all targets 30" - 50" in diameter
- Constructed using 1 1/3" galvanized steel tubing
- Large wheels allow for easy rolling

4 Year Limited Warranty
ARTARSTD **\$299⁹⁹** EA ★

ARCHERS' FAVORITE FIBERCLOTH FACES



ROUND TARGET FACES

- Long lasting, fibercloth material
- Waterproof - skirted

1282566	48" - Slip-On	\$49⁹⁹ EA ★
1282580	36" - Slip-On	\$32⁹⁹ EA ★

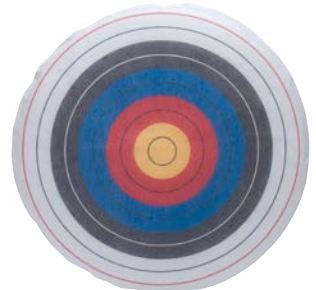

SQUARE TARGET FACES

- Long lasting, fibercloth material
- Waterproof - no skirt

1282573	48" - Flat	\$44⁹⁹ EA ★
1282597	36" - Flat	\$26⁹⁹ EA ★

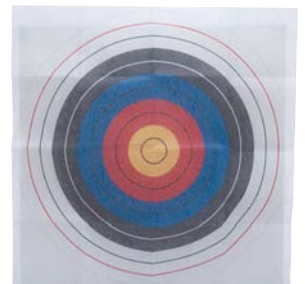

RECURVE BOWS

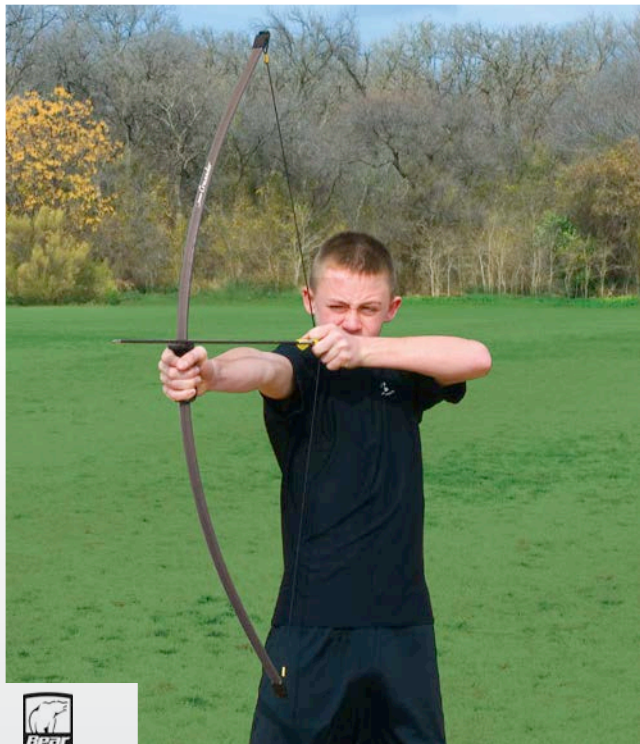

SOLID RECURVE BOWS

- Uses durable composite limbs with molded plastic handle
- Used nationwide by camp and school programs
- For left or right hand - bow string included

3752XXXX	Bow AMO 44", Draw Wt. 10-18 lbs. (Ages 5 to 10)	\$54⁹⁹ EA
3678XXXX	Bow AMO 51", Draw Wt. 10-20 lbs. (Ages 9+)	\$74⁹⁹ EA
3676XXXX	Bow AMO 60", Draw Wt. 30-35 lbs. (Ages 10+)	\$94⁹⁹ EA



ARCHERY STARTER KIT

PACKAGE INCLUDES:

- (3) foam targets, 36" diameter x 6" thick with 10 ring target face
- (3) tripod target stands
- (3) 60" - 20-29lb. draw youth bows
- (3) 60" - 30-35 lb. draw youth bows
- (72) 28" Safetyglass vaned arrows
- (6) armguards
- (6) shooting gloves (3 medium and 3 large)
- (3) ground quivers
- (1) archery manual
- (1) storage cart designed specifically to store this entire package

1072549

\$2,999⁹⁹ PACK 



MULTI-PURPOSE EQUIPMENT CART

- Constructed of 1" powder coated steel tubing
- Great for carrying PE and baseball equipment
- Polyester bag measures 24"H x 24"W x 12"D

1197655

46"H x 29"W x 30"D - 29 lbs. **\$499⁹⁹** EA ★



DOUBLE LOOP BOW STRINGS

With Center Serving

- Braided for bows up to 40 lbs.
- Please specify string length (3 per size)
- Length: **36", 52"**.

PAR50

\$49⁹⁹ PACK OF 3



COMPOUND BOWS



GENESIS BOWS

- Fiberglass and aluminum bow that is easy to shoot
- Combines "zero let-off" with light, adjustable 10-20 lb. draw weights that cover all standard draw lengths
- Official Bow of the National Archery in the Schools Program
- Color Options: **Blue, Green, Orange, Purple, Red, Yellow**
- Hand: **Right, Left.**

1255485

\$269⁹⁹ EA



GENESIS MINI BOW

- Same as the Genesis bow - for younger archers
- Weighs only 2 lbs. with adjustable draw weights of 6-12 lbs. to cover draw lengths from 14" - 25"
- Color Options: **Black, Blue, Red**
- Hand: **Right, Left.**

1255591

\$269⁹⁹ EA

MONARCH TAKEDOWN BOW

- 62" takedown bow designed for beginners
- Hard wood riser, wood core and fiberglass limbs
- Ready to shoot with arrow rest installed
- Shoots right or left handed
- Available in 20-25-29 lb. draw weights
- Hand: **Left, Right**
- Weight: **20 LB, 25 LB, 29 LB.**

1387750 Specify Hand and Draw Weight **\$153⁹⁹** EA

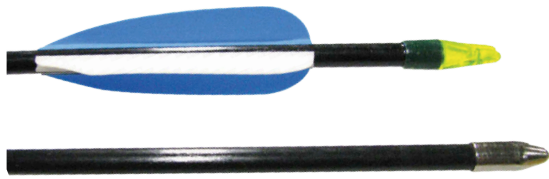

FIBERGLASS TARGET ARROWS

- Extremely durable, withstands much abuse
 - 3" plastic vanes and steel target point
 - Maximum spine weight 40 lbs.
- Length: 26", 28", 30".

20027506	Dz.	\$69 ⁹⁹	DZN
20027572	72 Pack	\$399 ⁹⁹	PACK OF 72
20027544	Gross	\$599 ⁹⁹	GROSS OF 144
1305067	Nocks 17/64"	\$54 ⁹⁹	PACK OF 100
1305074	Points 17/64"	\$7 ⁴⁹	DOZEN



SAFETYGLASS™ TARGET ARROWS

- Strong, durable, fiberglass arrows that flex and will not splinter
- Includes nock, point and vanes
- Spine weight maximum 29 lbs.

8102XXXX	26"	\$524 ⁹⁹	PACK OF 72
8114XXXX	Combo 24 Each 26" - 28" - 30"	\$524 ⁹⁹	PACK OF 72



SELECT WOOD ARROWS

These select grade arrows are made from the finest 5/16" wood shafts. Fletched with 3" feathers, snap nock, and lightweight crimp-on target point. Spine weight maximum 35 lbs. Available with cedar shafts or economy poplar wood shafts. Please specify length.

Length: 26", 28", 30".

1160123	Poplar Shafts - Dozen	\$86 ⁹⁹	DZN
1160130	Poplar Shafts - Pack of 72	\$464 ⁹⁹	PACK OF 72
1162950	Poplar Shafts - Pack of 144	\$819 ⁹⁹	GROSS OF 144

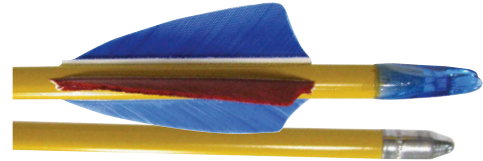

STANDARD WOOD ARROWS

- Standard grade arrows with 5/16" wood shafts
 - Features PVC vanes, snap-on nock and crimped steel target point
 - Maximum spine weight 35 lbs.
- Length: 24", 26", 28".

3791XXXX	Cedar Shafts - Dozen	\$86 ⁹⁹	DZN
3732XXXX	Cedar Shafts - Pack of 72	\$439 ⁹⁹	PACK OF 72 ★
3726XXXX	Cedar Shafts - Pack of 144	\$789 ⁹⁹	GROSS OF 144
1160109	Poplar Shafts - Dozen	\$74 ⁹⁹	DZN
1160116	Poplar Shafts - Pack of 72	\$394 ⁹⁹	PACK OF 72
1162943	Poplar Shafts - Pack of 144	\$729 ⁹⁹	GROSS OF 144



ARCHERY CUSTOM NETTING

FOR INDOOR AND OUTDOOR USE!

- Heavy-duty, fine mesh netting for use with bows up to 35 lbs.
- Support nets on guy wires from walls, HD portable standards or in-ground posts - not included
- Netting is bordered with grommets at top and corners
- Specify Size: 10' standard height - Order 10'H x desired length

SNARCHEYDS	\$2 ⁹⁹	SQ.FT
------------	-------------------	-------

PRE-CUT ARCHERY NETTING

1233810DS	16'W x 10'H	\$349 ⁹⁹	EA
1233827DS	26'W x 10'H	\$499 ⁹⁹	EA
1233834DS	36'W x 10'H	\$699 ⁹⁹	EA
1233841DS	50'W x 10'H	\$949 ⁹⁹	EA



6" ECONOMY ARMGUARD

- Vinyl leatherette with easy fasten hook for youth programs

3700XXXX	\$7 ⁹⁹	EA
----------	-------------------	----



6" DELUXE ARMGUARD

- Tough vinyl with 2 straps and hook and loop fasteners
- One size fits all - colors may vary

3759XXXX	\$19 ⁹⁹	EA
----------	--------------------	----



12" DELUXE ARMGUARD

- Tough vinyl with 4 straps and hook and loop fasteners
- One size fits all

3804XXXX	\$24 ⁹⁹	EA
----------	--------------------	----



GROUND QUIVER

- All steel - holds 12 arrows

3764XXXX	\$25 ⁹⁹	EA
----------	--------------------	----



AC Athletic Connection

TEAM SPORTS - STRENGTH & FITNESS - FACILITIES - P.E.

BASEBALL/SOFTBALL

BASKETBALL

FOOTBALL

HYDRATION

LACROSSE

FIELD HOCKEY

TENNIS

RACQUETBALL

BADMINTON

SOCCER

TRACK & FIELD

VOLLEYBALL

WRESTLING

WEIGHT LIFTING

CARDIO

FLOORING

CORE

SPEED/AGILITY

ASSESSMENT

MATS

GYMNASTICS

BOXING

COACHING

CONCESSIONS

FIELD MARKING

FLOOR COVERS

GAME TABLES

LOCKS & LOCKERS

BENCHES & BLEACHERS

PARKS

SCOREBOARDS

SPORTS MEDICINE

TRAFFIC SAFETY

STORAGE

WALL PADS

PHYSICAL EDUCATION